

# HEPA-Filtered Cleanroom Oven

© Copyright 2018 Terra Universal Inc. All rights reserved. • Revised July 2019

## Your Comprehensive Equipment Source

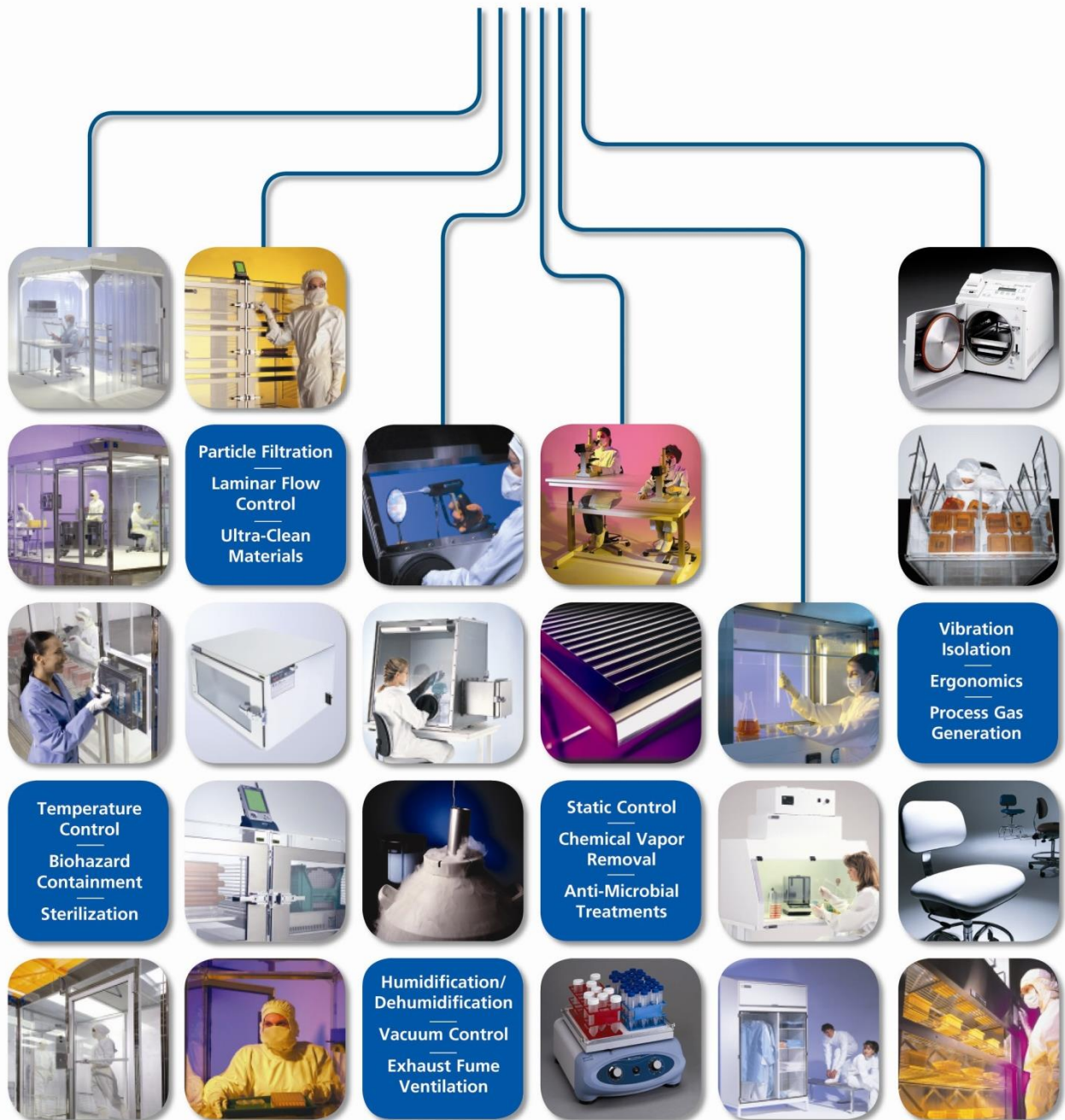



# HEPA-Filtered Cleanroom Oven

## Table of Contents

<b>1.0</b>	<b>Introduction .....</b>	<b>3</b>
<b>2.0</b>	<b>Description.....</b>	<b>3</b>
<b>3.0</b>	<b>Installation .....</b>	<b>4</b>
3.1	Site Preparation .....	4
3.2	Unpacking .....	4
3.3	Installation .....	4
<b>4.0</b>	<b>Operation .....</b>	<b>5</b>
4.1	Initial Start-Up .....	5
4.2	Changing the Set-Point.....	<b>Error! Bookmark not defined.</b>
<b>5.0</b>	<b>Maintenance.....</b>	<b>7</b>
5.1	Cleaning .....	8
5.2	Charcoal Filter Replacement.....	8
5.3	HEPA Filter Replacement .....	8
5.4	RTD Sensor Replacement .....	9
5.5	Replacing Door Gaskets .....	9
<b>6.0</b>	<b>Warranty.....</b>	<b>10</b>



## Proprietary Notice

This manual pertains to proprietary devices manufactured by Terra Universal, Inc. Neither this document nor any portion of it may be reproduced in any way without prior written permission from Terra Universal.

Terra Universal makes no warranties applying to information contained in this manual or its suitability for any implied or inferred purpose. Terra Universal shall not be held liable for any errors this manual contains or for any damages that result from its use.

## Safety Notice

A thorough familiarity with all operating guidelines is essential to safe operation of the product. Failure to observe safety precautions could result in poor performance, damage to the system or other property, or serious bodily injury or death.

The following symbols are intended to call your attention to two levels of hazard involved in operation:

The information presented here is subject to change without notice.



CAUTION

Cautions are used when failure to observe instructions could result in significant damage to equipment.



WARNING

Warnings are used when failure to observe instructions or precautions could result in injury or death.

## 1.0 Introduction

This manual provides information on installing and operating your Terra Universal High-Capacity HEPA-Filtered Cleanroom Oven.

For more information, please visit <https://www.laboratory-equipment.com/laboratory-equipment/hepa-high-capacity-ovens.php>.



### IMPORTANT NOTICE

The HEPA-Filtered Cleanroom Oven must be connected to an external exhaust duct for heat and fume removal. Failure to connect the unit to an exhaust system will result in heat, fumes and/or unfiltered air being released into the immediate surroundings.

Consult with your facility safety officer for applicable regulations.

## 2.0 Description

The High-Capacity HEPA-Filtered Cleanroom Oven performs economical drying, curing, and baking of high-volume samples at a stable, elevated temperature up to 60°C ( $\pm 2^\circ\text{C}$ ). Air flows down through the ceiling HEPA filters, circulating through the process chamber and back through the heating elements, ensuring temperature uniformity and a clean process environment. The equipped HEPA filters capture particles 0.3 microns or larger at 99.99% efficiency.

The blower motor runs continuously when switched on at the main disconnect panel. Operators should follow “lock-out, tag-out” procedures when performing service or maintenance. The temperature controller activates the heating elements as needed to reach the programmed temperature set-point.



A 6" electric damper is provided on top of the oven for connection to an exhaust system for heat and fume removal. When the door of the oven opens, a switch opens the vent to prevent heated air from continuing to flow into the chamber. The damper takes approximately 60 seconds to fully open. An activated charcoal filter below the damper adsorbs a broad range of organic compounds and solvent fumes.



In case of an emergency requiring immediate manual shutdown, close the main disconnect switch to cease all operation.

WARNING

## 3.0 Installation



Keep the shipping crate upright to avoid damaging the unit.

CAUTION

### 3.1 Site Preparation

- A. Make sure that the oven will be placed on a level, stable surface, away from damaging chemicals or flammable/explosive materials.
- B. Ensure the installation location allows the following: a minimum of 12" between the top of the unit and the ceiling and at least 6" between the unit and wall surfaces.
- C. Install a dedicated power source near the installation location in compliance with applicable electrical codes. Refer to your order specifications for electrical requirements.
- D. Prepare the existing exhaust system for connection to the vent on top of the oven.

### 3.2 Unpacking

Carefully remove the crating from around the oven and visually inspect for damage, both inside and out. Be sure not to throw away any accessory components with the packing material. Any damage should be reported according to the terms in the shipping agreement.

### 3.3 Installation



Do not lift the unit by the doors, handles or any other external component. Use a forklift or other lifting mechanism to handle the unit.

WARNING

- A. Carefully maneuver the oven over to the installation location. Secure the power cable to avoid damaging it.
- B. Adjust the feet to stabilize the oven.
- C. If the activated charcoal filter ships loose, see **Section 5.2** to install the filter below the electric damper.
- D. Connect the 6" damper to the external exhaust system.



- E. The door may need to be adjusted after shipping.
- F. Confirm the main disconnect switch is in the OFF position.
- G. Connect the unit to the power supply.

## 4.0 Operation



**WARNING**





Operators are responsible for inspecting the general condition of the unit before each use. Any worn or damaged component should be thoroughly examined and a safety evaluation should be performed before placing the unit back into service.

Follow facility safety guidelines and wear the designated PPE when working in or around the oven.

### 4.1 Initial Start-Up



# HEPA-Filtered Cleanroom Oven

- A. Once the unit is powered up, the blower will immediately begin operation. The temperature controller will flash RESET on the display and then proceed to RUN mode.
- B. When the controller is powered up, it displays its firmware version for 3 seconds, after which the controller starts normal operation. The value of **Measured Temperature** in red and **Set Point** in green is displayed.
- C. Press  up or  down to select the **Set Point**.
- D. Press and hold the **P** key for 2 seconds, until the display shows **Atun**.
- E. Press  up or  down to select either **FAST** or **FULL**. Press  to go back to the previous option.
- F. The **FAST** option performs the tuning in the minimum possible time, 10 - 30 minutes while the option **FULL** gives priority to accuracy over speed and may take a few hours.
- G. **TUNE** remains lit during the whole tuning phase. The user must wait for the tuning to be completed before using the controller. During auto tuning, the temperature will oscillate around the programmed set point and controller output will switch on and off many times.
- H. If the tuning does not result in a satisfactory control, refer to the Novus 1040 manual
- I. Once the oven is on, make sure to stand away from the opening when opening the door.

## 4.2 Display

The controller's front panel can be seen in **Fig. 02**:

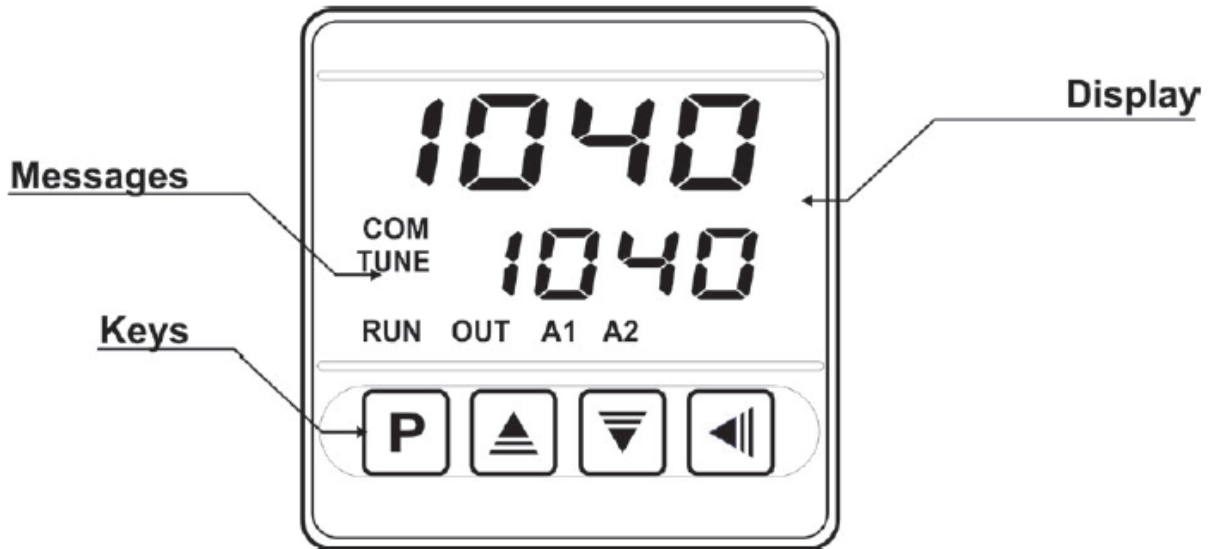

Figure 1. Temperature Controller





# HEPA-Filtered Cleanroom Oven



**Fig. 02** - Identification of the parts referring to the front panel

**Display:** Displays the measured variable, symbols of the configuration parameters and their respective values/conditions.

**COM Indicator:** Flashes to indicate communication activity in the RS485 interface.

**TUNE Indicator:** Stays ON while the controller is in tuning process.

**OUT Indicator:** For relay or pulse control output; it reflects the actual state of the output.

**A1 and A2 Indicators:** Signalize the occurrence of alarm situation.

**P Key:** Used to walk through the menu parameters.

 **Increment key and**  **Decrement key:** Allow altering the values of the parameters.

 **Back key:** Used to go back to the previous menu.

## 5.0 Maintenance



**WARNING**

Shut off the main disconnect switch and follow lock-out, tag-out procedures before performing any maintenance, repairs or service. Always disconnect the power cable from the power supply. Failure to observe these precautions could lead to exposure to high voltage electrical current.



**CAUTION**

Take care when cleaning to avoid excessive spraying, particularly when using conductive liquids, which can damage the electronic connections and components. Cleaning should be accomplished through controlled application of cleaning agents or pre-dampened wipers.



Always check material compatibility before selecting a cleaning agent.

## 5.1 Cleaning

Stainless steel should be cleaned with alcohol (or similar cleaning agent), used to dampen a non-shedding wiper.

When used in a cleanroom environment, Terra recommends use of knitted polyester wipers or spun-lace, non-woven blends of cellulose and polyester manufactured and packaged specifically for cleanroom use. These products are manufactured under tightly controlled conditions that restrict the use of binders or chemical treatments that can outgas, and cleanroom packaging and strict lot control ensure optimal cleanliness. Less critical environments (ISO 6 – 8 / Class 1000 – 100,000) generally tolerate more absorbent materials made of 100% cotton twill or cellulose.

Clean surfaces with clean, lukewarm water with or without a mild, non-abrasive detergent. In critical cleanroom applications, DI water may be required.

Avoid cleaning with a circular motion, which rubs dirt or grit into the surface. Using mild pressure, wipe in one direction, from top to bottom or side to side, in slightly overlapping strokes. Fold the wiper between strokes, and replace with a clean wiper often.

## 5.2 Charcoal Filter Replacement

Use appropriate PPE for handling the substances that may have been adsorbed by the charcoal filter.

- A. Remove the nuts around the base of the electric damper.
- B. Slowly lift the damper up to access the charcoal filter. If necessary, disconnect the wiring to the damper switch to more easily lift the filter housing out of the way.
- C. Dispose of the used charcoal filter and insert a new one.
- D. Reinstall the electric damper.

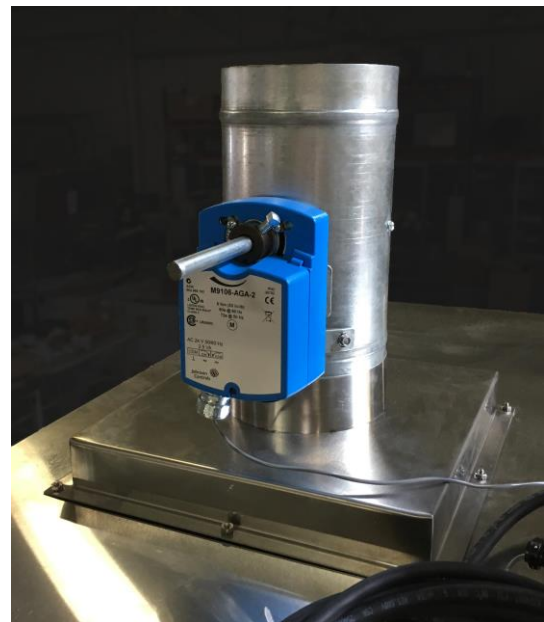

Figure 2. Electric Damper (square filter inside base)

## 5.3 HEPA Filter Replacement





Replacement intervals depend on frequency of use and particle load in the ambient environment. As the filter loads, fan operation will become noisier and the air speed will diminish. A recommended filter monitoring protocol is to measure the air speed approximately 6" below the filter face using a hand-held anemometer. When the air speed drops below 70 feet/minute, a filter change is recommended.

To replace the HEPA filters:

- A. Remove the screws holding the top panel to the upper housing.
- B. Slowly tilt the panel up on one end, taking care not to disconnect any of the internal wiring. Secure the panel in the lifted position or have an assistant hold it up.
- C. Detach the brackets holding the HEPA filters in place by loosening the two screws. Do not touch the face of the HEPA filter. Only handle the filters by the aluminum frame.
- D. Replace the old HEPA filters with the new ones and reinstall the brackets. Slowly tighten the brackets down until the filter is correctly positioned in the opening and snug against the surface.
- E. Reinstall the top panel.

Speak with Terra customer service to order replacement filters (two required).

## 5.4 RTD Sensor Replacement

Temperature sensors can be replaced by following the steps above to access the upper housing. Locate the two sensors, disconnect the wire, and loosen the nut that secures the sensor.

## 5.5 Replacing Door Gaskets

The door gaskets used are extremely durable but can still be damaged. The one-piece gasket is mechanically fastened around the door frame with screws.

Speak with Terra customer service to order a replacement door gasket.

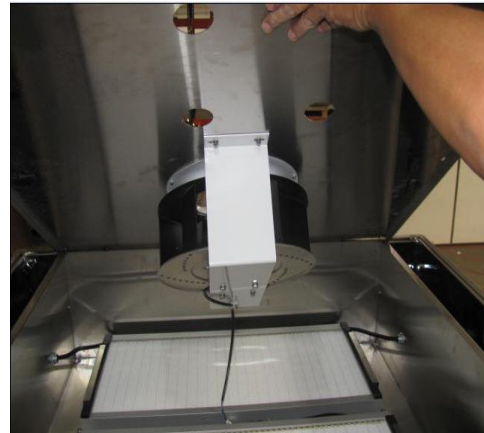

**Figure 3.** Tilt up the top panel to expose the filters

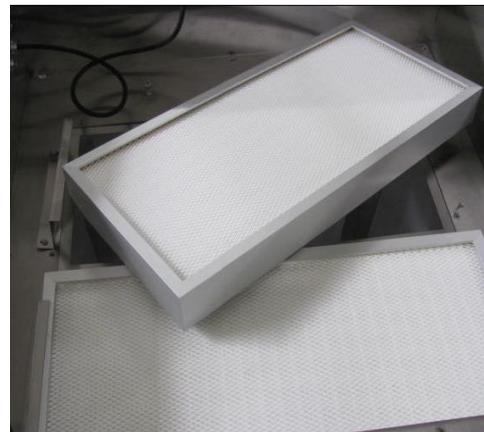

**Figure 4.** Detach the retaining brackets to remove the old filters and carefully insert the new HEPA filters



## 6.0 Warranty

**Products Manufactured by Terra:** Terra Universal, Inc., warrants products that it manufactures to be free from defects for a period of 12 months for parts and 90 days for labor, commencing from the date of shipment. Terra's sole responsibility is to repair or replace, at its option, any part of the product that proves defective or malfunctioning during this time limit. In some cases, components incorporated in Terra Universal products are covered by additional warranties from component manufacturers; obtain specific information from Terra sales representatives. This warranty is void if the equipment is abused or modified by the customer, is operated outside Terra's operating instructions or specifications, or is used in any application other than that for which it is specified. This warranty does not include routine maintenance or service procedures, breakage of quartz baths after 60 days, shipping damage, nor damage from misuse, intentional or unintentional abuse, neglect, natural disasters, or acts of God.

**Products Manufactured by Others:** Terra Universal, Inc., warrants that, to the best of its ability, Terra's representations of products that are manufactured by others reflect the manufacturer's representations, subject to change without notice. Sole warranty for these products is the original manufacturer's warranty that is passed forward to the purchaser and constitutes the customer's sole remedy for these products. Detailed warranties for distributed products are available through Terra sales representatives.

**Freight Shortage or Damage:** Upon receipt of any equipment from Terra Universal, Inc., customer shall immediately unpack and inspect for damage or shortage. The customer shall not accept a damaged package or a short shipment until the carrier makes a "damage or shortage" notation on both the carrier's and customer's copy of the freight bill or delivery receipt. Service title passes when the shipment is loaded, so customer is responsible for filing and collecting a freight claim. Any replacement products must be ordered and paid for separately. For Terra's "Policy and Procedures for Returning Goods," see Terra's Internet site: [www.TerraUniversal.com](http://www.TerraUniversal.com).

Generally, customers can improve the chance of collecting on a freight claim by following these procedures: 1) formally requesting that the carrier inspect the shipment immediately upon suspecting damage or shortage to verify condition; 2) notifying the carrier upon discovery of concealed damage and requesting an inspection within 15 days of receipt, both in person or phone and following up via mail; 3) keeping the shipment as intact as possible, including retaining original packaging materials and keeping the product as close to the original receiving location as possible; 4) holding salvage for disposition by the carrier.

**All Claims:** Terra Universal expressly disclaims all other warranties, expressed or implied or implied by statute, including the warranties of merchantability or fitness for intended use. Terra Universal is not responsible for consequential or incidental damages arising out of the purchase or use of the products supplied by Terra Universal. Terra Universal is not liable for damage to facilities, other equipment, products, property or personnel of others, or of their agents, suppliers, or affiliated parties, which is caused or alleged to have been caused by products supplied by Terra Universal. In any event or series of events, Terra Universal's total liability for any and all damages whatsoever is limited to the lesser of the actual damages or the original invoice cost of the items alleged to have caused the damage. The customer's sole and exclusive remedy for any cause of action whatsoever is repair or replacement of the non-conforming products or refund of the actual purchase price, at the sole option of Terra Universal. All claims must be made in writing within 90 days of the date the product was shipped. Any claims not made within this time limit shall be deemed waived by the customer. Terra Universal is not responsible for any additional costs of repair caused by poor packaging or in-shipment damage during return.

**Warranty Returns:** All warranty returns must be authorized in advance by Terra Universal and approved under an RMA. Unless approved in advance for good reason, all returns must be in original condition, including all manuals, and must be packaged in original packaging materials. All returned goods are to be shipped to Terra Universal, freight prepaid at customer's expense. See Terra's "Policy and Procedure for Returned Goods."

*Thank you for ordering from  
Terra Universal!*



# N1040 Controller

## TEMPERATURE CONTROLLER – INSTRUCTIONS MANUAL – V2.1x D

### SAFETY ALERTS

The symbols below are used on the equipment and throughout this document to draw the user's attention to important operational and safety information.

<b>CAUTION:</b> Read the manual thoroughly before installing and operating the equipment.	<b>CAUTION OR DANGER:</b> Electrical shock hazard

All safety related instructions that appear in the manual must be observed to ensure personal safety and to prevent damage to either the instrument or the system. If the instrument is used in a manner not specified by the manufacturer, the protection provided by the equipment may be impaired.

### INSTALLATION / CONNECTIONS

The controller must be fastened on a panel, following the sequence of steps described below:

- Prepare a panel cut-out according Specifications;
- Remove the mounting clamps from the controller;
- Insert the controller into the panel cut-out;
- Slide the mounting clamp from the rear to a firm grip at the panel.

### ELECTRICAL CONNECTIONS

Fig. 01 below shows the electrical terminals of the controller:

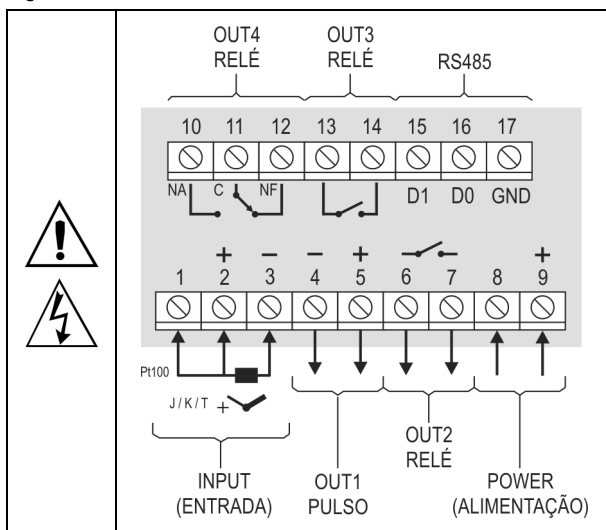

Fig. 01 - Connections of the back panel

### RECOMMENDATIONS FOR THE INSTALLATION

- All electrical connections are made to the screw terminals at the rear of the controller.
- To minimize the pick-up of electrical noise, the low voltage DC connections and the sensor input wiring should be routed away from high-current power conductors. If this is impractical, use shielded cables. In general, keep cable lengths to a minimum.
- All electronic instruments must be powered by a clean mains supply, proper for instrumentation.
- It is strongly recommended to apply RC'S FILTERS (noise suppressor) to contactor coils, solenoids, etc. In any application it is essential to consider what can happen when any part of the system fails. The controller features by themselves cannot assure total protection.

### FEATURES

#### INPUT TYPE SELECTION

Table 01 shows the sensor types accepted and their respective codes and ranges. Access the parameter **TYPE** in the INPUT cycle to select the appropriate sensor.

TYPE	CODE	RANGE OF MEASUREMENT
Thermocouple J	<b>J</b>	Range: -110 to 950 °C (-166 to 1742 °F)
Thermocouple K	<b>K</b>	Range: -150 to 1370 °C (-238 to 2498 °F)
Thermocouple T	<b>T</b>	Range: -160 to 400 °C (-256 to 752 °F)
Pt100	<b>Pt</b>	Range: -200 to 850 °C (-328 to 1562 °F)

Table 01 – Input types

#### OUTPUTS

The controller offers two, three or four output channels, depending on the loaded optional features. The output channels are user configurable as **Control Output**, **Alarm 1 Output**, **Alarm 2 Output**, **Alarm 1 OR Alarm 2 Output** and **LBD (Loop Break Detect) Output**.

**OUT1** - Logical pulse, 5 Vdc / 25 mA, available at terminals 4 and 5.

**OUT2** - Relay SPST-NA. Available at terminals 6 and 7.

**OUT3** - Relay SPST-NA. Available at terminals 13 and 14.

**OUT4** - Relay SPDT, available at terminals 10, 11 and 12.

#### CONTROL OUTPUT

The control strategy can be **ON/OFF** (when **Pb = 0.0**) or **PID**. The PID parameters can be automatically determined enabling the auto-tuning function (**Autun**).

**ALARM OUTPUT**

The controller contains 2 alarms that can be directed (assigned) to any output channel. The alarm functions are described in **Table 02**.

<b>oFF</b>	Output is not used as alarm.	
<b>Lo</b>	Alarm of Absolute Minimum Value. Triggers when the value of measured PV is <b>below</b> the value defined for alarm <i>Setpoint</i> . ( <i>SPA1</i> or <i>SPA2</i> ).	
<b>Hi</b>	Alarm of Absolute Maximum Value. Triggers when the value of measured PV is <b>above</b> the value defined for alarm <i>Setpoint</i> .	
<b>dIF</b>	Alarm of Differential Value. In this function the parameters <b>SPR1</b> and <b>SPR2</b> represent the deviation of PV in relation to the SP of CONTROL.	
	 Positive SPA1	 Negative SPA1
<b>dIFL</b>	Alarm of Minimum Differential Value. It triggers when the value of PV is <b>below</b> the defined point by (using the Alarm 1 as example).	
	 Positive SPA1	 Negative SPA1
<b>dIFH</b>	Alarm of Valor Maximum Differential Value. Triggers when the value of PV is <b>above</b> the defined point by (using Alarm 1 as example):	
	 Positive SPA1	 Negative SPA1
<b>IErr</b>	Alarms of the Sensor Break (Sensor <i>Break Alarm</i> ). It is activated when the Input presents problems such as interrupted sensor, bad connection, etc.	

**Table 02** – Alarm functions

**Note:** Alarm functions on **Table 02** are also valid for Alarm 2 (SPA2).

**Important note:** Alarms configured with the **Hi**, **dIF** and **dIFH** functions also trigger their associated output when a sensor fault is identified and signaled by the controller. A relay output, for example, configured to act as a High Alarm (**Hi**), will operate when the SPAL value is exceeded and also when the sensor connected to the controller input is broken.

**INITIAL BLOCKING OF ALARM**

The **initial blocking** option inhibits the alarm from being recognized if an alarm condition is present when the controller is first energized. The alarm will be enabled only after the occurrence of a non-alarm condition.

The initial blocking is useful, for example, when one of the alarms is configured as a minimum value alarm, causing the activation of the alarm soon upon the process start-up, an occurrence that may be undesirable.

The initial blocking is disabled for the sensor break alarm function **IErr** (Open sensor).

**SAFE OUTPUT VALUE WITH SENSOR FAILURE**

Function that places the control output in a safe condition for the process when is identified an error in the sensor input.

With a fault identified in the sensor, the controller determines the percentage value defined in parameter **IEou** for the control output. The controller will remain in this condition until the sensor failure disappears. **IEou** values are only 0 and 100 % when in ON/OFF control mode. For PID control mode, any value in the range from 0 to 100 % is accepted.

**LBD FUNCTION – LOOP BREAK DETECTION**

The **Lbdt** parameter defines a time interval, in minutes, within which the PV is expect to react to a control output signal. If the PV does not react properly within the time interval configured, the controller signals in its display the occurrence of the LBD event, which indicates problems in the control loop.

The LBD event can also be sent to one of the output channels of the controller. To do this, simply configure the desired output channel with the **Ldb** function which, in the event of this event, is triggered.

This function is disabled with value 0 (zero).

This function allows the user to detect problems in the installation, such as defective actuators, power supply failure, etc.

**OFFSET**

Feature that allows the user to make small adjustment in the PV indication. Allows correcting measurement errors that appear, for example, when replacing the temperature sensor.

**USB INTERFACE**

The USB interface is used for CONFIGURING or MONITORING the controller. The **NConfig** software must be used for the configuration. It makes it possible to create, view, save and open configurations from the equipment or files in your computer. The tool for saving and opening configurations in files makes it possible to transfer configurations between pieces of equipment and to make backup copies. For specific models, the **NConfig** software also makes it possible to update the firmware (internal software) of the controller through the USB.

For MONITORING purposes you can use any supervisory software (SCADA) or laboratory software that supports the MODBUS RTU communication on a serial communications port. When connected to the USB of a computer, the controller is recognized as a conventional serial port (COM x). Use the **NConfig** software or consult the DEVICE MANAGER in the Windows CONTROL PANEL to identify the COM port that was assigned to the controller. Consult the mapping of the MODBUS memory in the controller’s communications manual and the documentation of your supervisory software to conduct the MONITORING process.

Follow the procedure below to use the USB communication of the equipment:

1. Download the **NConfig** software from our website and install it on your computer. The USB drivers necessary for operating the communication will be installed together with the software.
2. Connect the USB cable between the equipment and the computer. The controller does not have to be connected to a power supply. The USB will provide enough power to operate the communication (other equipment functions cannot operate).
3. Open the **NConfig** software, configure the communication and start recognition of the device.

 	<p>The USB interface IS NOT SEPARATE from the signal input (PV) or the controller’s digital inputs and outputs. It is intended for temporary use during CONFIGURATION and MONITORING periods. For the safety of people and equipment, it must only be used when the piece of equipment is completely disconnected from the input/output signals. Using the USB in any other type of connection is possible but requires a careful analysis by the person responsible for installing it. When MONITORING for long periods of time and with connected inputs and outputs, we recommend using the RS485 interface.</p>
------	---

**OPERATION**

The controller's front panel, with its parts, can be seen in the Fig. 02:

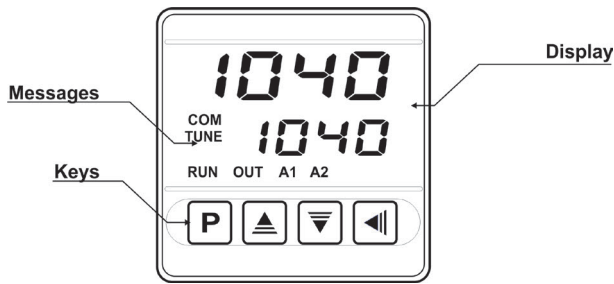

Fig. 02 - Identification of the parts referring to the front panel

**Display:** Displays the measured variable, symbols of the configuration parameters and their respective values/conditions.

**COM Indicator:** Flashes to indicate communication activity in the RS485 interface.

**TUNE Indicator:** Stays ON while the controller is in tuning process.

**OUT Indicator:** For relay or pulse control output; it reflects the actual state of the output.

**A1 and A2 Indicators:** Signalize the occurrence of alarm situation.

**P Key:** Used to walk through the menu parameters.

**▲ Increment key and ▼ Decrement key:** Allow altering the values of the parameters.

**◀ Back key:** Used to retrocede parameters.

**STARTUP**

When the controller is powered up, it displays its firmware version for 3 seconds, after which the controller starts normal operation. The value of PV and SP is then displayed and the outputs are enabled.

In order for the controller to operate properly in a process, its parameters need to be configured first, such that it can perform accordingly to the system requirements. The user must be aware of the importance of each parameter and for each one determine a valid condition.

The parameters are grouped in levels according to their functionality and operation easiness. The 5 levels of parameters are:

- 1 – Operation / 2 – Tuning / 3 – Alarms / 4 – Input / 5 – Calibration

The “P” key is used for accessing the parameters within a level.

Keeping the “P” key pressed, at every 2 seconds the controller jumps to the next level of parameters, showing the first parameter of each level:

**PV >> R<sub>tun</sub> >> F<sub>uA1</sub> >> t<sub>YPE</sub> >> P<sub>ASS</sub> >> PV ...**

To enter a particular level, simply release the “P” key when the first parameter in that level is displayed. To walk through the parameters in a level, press the “P” key with short strokes. To go back to the previous parameter in a cycle, press **◀**:

Each parameter is displayed with its prompt in the upper display and value/condition in the lower display. Depending on the level of parameter protection adopted, the parameter **PASS** precedes the first parameter in the level where the protection becomes active. See section **Configuration Protection**.

**DESCRIPTION OF THE PARAMETERS**

**OPERATION CYCLE**

<b>PV + SP</b>	<b>PV Indication screen.</b> On the higher display (red) the value of the measured variable (PV) temperature is shown. On the lower display (green), the control setpoint (SP) is shown.
<b>SPR1</b> <b>SPR2</b>	<b>Alarm SP.</b> Value that defines the alarm activation point. For the alarms set up with the functions of the type <b>Differential</b> , these parameters define deviations. For the alarm function <b>IErr</b> , this parameter is not used. Parameters shown in this level only when enabled in the parameters <b>SP1E</b> and <b>SP2E</b> .

**TUNING CYCLE**

<b>R<sub>tun</sub></b>	<b>AUTO-TUNE.</b> Enables the auto-tuning function for the PID parameters ( <b>P<sub>b</sub></b> , <b>I<sub>r</sub></b> , <b>d<sub>t</sub></b> ). Defines the control strategy to be taken: <b>oFF</b> - Turned off (no PID tuning); <b>F<sub>AST</sub></b> - Automatic tuning; <b>F<sub>ULL</sub></b> - More accurate automatic tuning.
<b>P<sub>b</sub></b>	<b>Proportional Band.</b> Value of the term <b>P</b> of the control mode PID, in percentage of the maximum span of the input type. Adjust of between 0 and 500.0 %. <b>When set to zero (0), control action is ON/OFF.</b>
<b>I<sub>r</sub></b>	<b>Integral Rate.</b> Value of the term <b>I</b> of the PID algorithm, in repetitions per minute (Reset). Adjustable between 0 and 24.00. Displayed only if proportional band ≠ 0.
<b>d<sub>t</sub></b>	<b>Derivative Time.</b> Value of the term <b>D</b> of the control mode PID, in seconds. Adjustable between 0 and 250.0 seconds. Displayed only if proportional band ≠ 0.
<b>t<sub>t</sub></b>	<b>Cycle time.</b> Pulse Width Modulation (PWM) period in seconds. Adjustable between 0.5 and 100.0 seconds. Displayed only if proportional band ≠ 0.
<b>H<sub>YS</sub>t</b>	<b>Hysteresis.</b> Is the hysteresis for ON/OFF control (set in temperature units). This parameter is only used when the controller is in ON/OFF mode ( <b>P<sub>b</sub>=0</b> ).
<b>A<sub>CT</sub></b>	<b>Action Control:</b> <b>r<sub>E</sub></b> Control with <b>Reverse Action</b> . Appropriate for <b>heating</b> . Turns control output on when PV is below SP. <b>d<sub>I</sub>r</b> Control with <b>Direct Action</b> . Appropriate for <b>cooling</b> . Turns control output on when PV is above SP.
<b>S<sub>F</sub>S<sub>t</sub></b>	<b>SoftStart Function.</b> Time interval, in seconds, while the controller limits the control output (MV) rising rate. (Zero value disables the Soft Start function).
<b>O<sub>ut</sub> 1</b> <b>O<sub>ut</sub> 2</b> <b>O<sub>ut</sub> 3</b> <b>O<sub>ut</sub> 4</b>	Assign functions to the Output channels OUT1, OUT2, OUT3 and OUT4: <b>oFF</b> - Not used; <b>t<sub>Er</sub>L</b> - Control output; <b>A 1</b> - Alarm 1 output; <b>A 2</b> - Alarm 2 output; <b>A 1A 2</b> - Alarm 1 + Alarm2 (OR logic); <b>L<sub>bd</sub></b> - Loop Break Detect Alarm.

**ALARMS CYCLE**

<b>FuA1 FuA2</b>	Functions of Alarms. Defines the functions for the alarms among the options of the <b>Table 02</b> .
<b>SPA1 SPA2</b>	Alarm SP. Value that defines the point of activation of the alarm outputs.  For the alarms programmed with the functions of the type <b>Differential</b> , these parameters represent the deviations.  For the <b>iErr</b> alarm function, this parameter has no meaning.
<b>SP1E SP2E</b>	SP Enable. Configures display of SPA1 and SPA2 also in the Operation Cycle.  <b>YES</b> SPA1/SPA2 are displayed in the Operation Cycle  <b>no</b> SPA1/SPA2 are not displayed in the Operation Cycle
<b>bLA1 bLA2</b>	Blocking Alarms.  <b>YES</b> - Enables initial blocking; <b>no</b> - Inhibits initial blocking.
<b>HYA1 HYA2</b>	Alarm Hysteresis. Defines the difference between the value of PV at which the alarm is triggered and the value at which it is turned off.
<b>FLSh</b>	Allows visual signalization of an alarm occurrence by flashing the indication of PV in the operation level.  <b>YES</b> - Enables alarm signaling flashing PV; <b>no</b> - Disables alarm signaling flashing PV.

**INPUT CYCLE**

<b>TYPE</b>	Input Type. Selects the input signal type to be connected to the process variable input. Refer to <b>Table 01</b> for the available options.  (J): <b>tc J</b> -110 to 950 °C / -166 to 1742 °F (K): <b>tc P</b> -150 to 1370 °C / -238 to 2498 °F (T): <b>tc t</b> -160 to 400 °C / -256 to 752 °F (Pt100): <b>Pt</b> -200 to 850 °C / -328 to 1562 °F
<b>FLtr</b>	Digital Input Filter. Used to improve the stability of the measured signal (PV). Adjustable between 0 and 20. In 0 (zero) it means filter turned off and 20 means maximum filter. The higher the filter value, the slower is the response of the measured value.
<b>dPp0</b>	Selects the decimal point position to be viewed in both PV and SP.
<b>un: t</b>	Selects display indication for degrees Celsius or Fahrenheit: <b>C</b> - Indication in Celsius; <b>F</b> - Indication in Fahrenheit.
<b>OFF5</b>	Offset value to be added to the PV reading to compensate sensor error. Default value: Zero.
<b>SPLL</b>	SP Low Limit. Defines the SP lower limit of.
<b>SPHL</b>	SP High Limit. Defines the upper limit for adjustment of SP.
<b>Lbd t</b>	Loop Break Detection Time. Time interval for the LBD function. Defines the maximum interval of time for the PV to react to a control command. In minutes.
<b>iEou</b>	Percentage value to be applied to the output on any failure of the sensor that is connected to the controller input.
<b>bAud</b>	Digital communication Baud Rate selection. In kbps with the following speeds available: 1.2, 2.4, 4.8, 9.6, 19.2, 38.4, 57.6 and 115.2.  Parameter shown only on models with serial communication.

<b>Prty</b>	Parity of the serial communication.  <b>nonE</b> Without parity; <b>E:En</b> Even parity; <b>Odd</b> Odd parity.  Parameter shown only on models with serial communication.
<b>Addr</b>	Communication Address. Number that identifies the controller in the serial communication network, between 1 and 247.  Parameter shown only on models with serial communication.

**CALIBRATION CYCLE**

All types of input are calibrated in the factory. In case a recalibration is required; it shall be carried out by a specialized professional. In case this cycle is accidentally accessed, do not perform alteration in its parameters.

<b>PASS</b>	Password. This parameter is presented before the protected cycles. See item Protection of Configuration.
<b>CAL Ib</b>	Calibration. Enables the possibility for calibration of the indicator. When the calibration is not enabled, the related parameters are hidden.
<b>InLC</b>	Input Low Calibration. Enter the value corresponding to the low scale signal applied to the analog input.
<b>InHC</b>	Input High Calibration. Enter the value corresponding to the full scale signal applied to the analog input.
<b>rStE</b>	Restore. Restores the factory calibration for all inputs and outputs, disregarding modifications carried out by the user.
<b>CJ</b>	Cold Junction. This screen is for information purpose only.
<b>PASC</b>	Password Change. Allows defining a new access password, always different from zero
<b>Prot</b>	Protection. Sets up the Level of Protection. See <b>Table 04</b> .

**CONFIGURATION PROTECTION**

The controller provides means for protecting the parameters configurations, not allowing modifications to the parameters values, avoiding tampering or improper manipulation. The parameter **Protection (Prot)**, in the Calibration level, determines the protection strategy, limiting the access to particular levels, as shown by the **Table 04**.

PROTECTION LEVEL	PROTECTION CYCLES
1	Only the Calibration cycle is protected.
2	Calibration and Input cycles.
3	Calibration, Input and Alarms cycles.
4	Calibration, Input, Alarms and Tuning cycles.
5	All cycles are protected, but the SP screen in the operation cycle.
6	All cycles are protected, including SP.

**Table 04** – Levels of Protection for the Configuration



**ACCESS PASSWORD**

The protected levels, when accessed, request the user to provide the **Access Password** for granting permission to change the configuration of the parameters on these levels.

The prompt **PASS** precedes the parameters on the protected levels. If no password is entered, the parameters of the protected levels can only be visualized.

The Access Password is defined by the user in the parameter *Password Change* (**PASC**), present in the Calibration Level. **The factory default for the password code is 1111.**

**PROTECTION ACCESS PASSWORD**

The protection system built into the controller blocks for 10 minutes the access to protected parameters after 5 consecutive frustrated attempts of guessing the correct password.

**MASTER PASSWORD**

The Master Password is intended for allowing the user to define a new password in the event of it being forgotten. The Master Password doesn't grant access to all parameters, only to the *Password Change* parameter (**PASC**). After defining the new password, the protected parameters may be accessed (and modified) using this new password.

The master password is made up by the last three digits of the serial number of the controller **added** to the number 9000. As an example, for the equipment with serial number 07154321, the master password is 9 3 2 1.

Controller serial number is displayed by pressing **◀** for 5 seconds.

**DETERMINATION OF PID PARAMETERS**

During the process of determining automatically the PID parameters, the system is controlled in **ON/OFF** in the programmed Setpoint. The auto-tuning process may take several minutes to be completed, depending on the system. The steps for executing the PID auto-tuning are:

- Select the process Setpoint.
- Enable auto-tuning at the parameter "**Auto**", selecting **FAS** or **FULL**.

The option **FAS** performs the tuning in the minimum possible time, while the option **FULL** gives priority to accuracy over the speed.

The sign TUNE remains lit during the whole tuning phase. The user must wait for the tuning to be completed before using the controller.

During auto tuning period the controller will impose oscillations to the process. PV will oscillate around the programmed set point and controller output will switch on and off many times.

If the tuning does not result in a satisfactory control, refer to **Table 05** for guidelines on how to correct the behavior of the process.

PARAMETER	VERIFIED PROBLEM	SOLUTION
<b>Band Proportional</b>	Slow answer	Decrease
	Great oscillation	Increase
<b>Rate Integration</b>	Slow answer	Increase
	Great oscillation	Decrease
<b>Derivative Time</b>	Slow answer or instability	Decrease
	Great oscillation	Increase

**Table 05** - Guidance for manual adjustment of the PID parameters

**MAINTENANCE**

**PROBLEMS WITH THE CONTROLLER**

Connection errors and inadequate programming are the most common errors found during the controller operation. A final revision may avoid loss of time and damages.

The controller displays some messages to help the user identify problems.

MESSAGE	DESCRIPTION OF THE PROBLEM
----	Open input. No sensor or signal.
<b>Err 1</b> <b>Err 6</b>	Connection and/or configuration problems. Check the wiring and the configuration.

Other error messages may indicate hardware problems requiring maintenance service.

**CALIBRATION OF THE INPUT**

All inputs are factory calibrated and recalibration should only be done by qualified personnel. If you are not familiar with these procedures do not attempt to calibrate this instrument.

The calibration steps are:

- Configure the input type to be calibrated in the **TYPE** parameter.
- Configure the lower and upper limits of indication for the maximum span of the selected input type.
- Go to the Calibration Level.
- Enter the access password.
- Enable calibration by setting YES in **CAL Ib** parameter.
- Using an electrical signals simulator, apply a signal a little higher than the **low** indication limit for the selected input.
- Access the parameter "**InLc**". With the keys **▲** and **▼** adjust the display reading such as to match the applied signal. Then press the **P** key.
- Apply a signal that corresponds to a value a little lower than the **upper** limit of indication.
- Access the parameter "**InLc**". With the keys **▲** and **▼** adjust the display reading such as to match the applied signal.
- Return to the Operation Level.
- Check the resulting accuracy. If not good enough, repeat the procedure.

**Note:** When checking the controller calibration with a Pt100 simulator, pay attention to the simulator minimum excitation current requirement, which may not be compatible with the 0.170 mA excitation current provided by the controller.

**SERIAL COMMUNICATION**

The controller can be supplied with an asynchronous RS-485 digital communication interface for master-slave connection to a host computer (master). The controller works as a slave only and all commands are started by the computer which sends a request to the slave address. The addressed unit sends back the requested reply. Broadcast commands (addressed to all indicator units in a multidrop network) are accepted but no reply is sent back in this case.

**CHARACTERISTICS**

- Signals compatible with RS-485 standard. MODBUS (RTU) Protocol. Two wire connection between 1 master and up to 31 (addressing up to 247 possible) instruments in bus topology.
- Communication signals are electrically isolated from the INPUT and POWER terminals. Not isolated from the retransmission circuit and the auxiliary voltage source when available.
- Maximum connection distance: 1000 meters.
- Time of disconnection: Maximum 2 ms after last byte.
- Programmable baud rate: 1200 to 115200 bps.
- Data Bits: 8.
- Parity: Even, Odd or None.
- Stop bits: 1
- Time at the beginning of response transmission: maximum 100 ms after receiving the command.

The RS-485 signals are:

D1	D	D +	B	Bi-directional data line.	Terminal 15
D0	$\bar{D}$	D -	A	Bi-directional inverted data line.	Terminal 16
C			Optional connection that improves the performance of the communication.	Terminal 17	
GND					

**CONFIGURATION OF PARAMETERS FOR SERIAL COMMUNICATION**

Two parameters must be configured for using the serial type:

**bAud:** Communication speed.

**Prty:** Parity of the communication.

**Addr:** Communication address for the controller.

**REDUCED REGISTERS TABLE FOR SERIAL COMMUNICATION**

**Communication Protocol**

The MOSBUS RTU slave is implemented. All configurable parameters can be accessed for reading or writing through the communication port. Broadcast commands are supported as well (address 0).

The available Modbus commands are:

03 - Read Holding Register

06 - Preset Single Register

05 - Force Single Coil

**Holding Registers Table**

Follows a description of the usual communication registers. For full documentation download the Registers Table for Serial Communication in the N1040 section of our website – [www.novusautomation.com](http://www.novusautomation.com).

All registers are 16 bit signed integers.

Address	Parameter	Register Description
0000	Active SP	Read: Active control SP (main SP, from ramp and soak or from remote SP). Write: To main SP. Range: from <b>SPLL</b> to <b>SPHL</b> .

0001	PV	Read: Process Variable. Write: Not allowed. Range: Minimum value is the one configured in <b>SPLL</b> and the maximum value is the one configured in <b>SPHL</b> . Decimal point position depends on <b>dPPo</b> value. In case of temperature reading, the value read is always multiplied by 10, independently of <b>dPPo</b> value.
0002	MV	Read: Output Power in automatic or manual mode. Write: Not allowed. See address 29. Range: 0 to 1000 (0.0 to 100.0 %).

**IDENTIFICATION**

<b>N1040 -</b>	<b>A -</b>	<b>B -</b>	<b>C</b>
----------------	------------	------------	----------

**A: Outputs Features**

**PR:** OUT1= Pulse / OUT2= Relay

**PRR:** OUT1= Pulse / OUT2=OUT3= Relay

**PRRR:** OUT1= Pulse / OUT2=OUT3= OUT4= Relay

**B: Digital Communication**

**485:** Available RS485 digital communication

**C: Power Supply electric**

**(Blank):** 100~240 Vac / 48~240 Vdc; 50~60 Hz

**24V:** 12~24 Vdc / 24 Vac

**SPECIFICATIONS**

**DIMENSIONS:**..... 48 x 48 x 80 mm (1/16 DIN)

Cut-out in the panel:..... 45.5 x 45.5 mm (+0.5 -0.0 mm)

Approximate Weight: .....75 g

**POWER SUPPLY:**

Model standard:..... 100 to 240 Vac ( $\pm 10\%$ ), 50/60 Hz

..... 48 to 240 Vdc ( $\pm 10\%$ )

Model 24 V: ..... 12 to 24 Vdc / 24 Vac (-10 % / +20 %)

Maximum consumption: ..... 6 VA

**ENVIRONMENTAL CONDITIONS:**

Operation Temperature: ..... 0 to 50 °C

Relative Humidity:..... 80 % @ 30 °C

For temperatures above 30 °C, reduce 3 % for each °C

Internal use; Category of installation II, Degree of pollution 2;

altitude < 2000 meters

**INPUT**..... Thermocouples **J; K; T** and **Pt100** (according of **Table 01**)

Internal Resolution:..... 32767 levels (15 bits)

Resolution of Display:..... 12000 levels (from -1999 up to 9999)

Rate of Input Reading: .....up 10 per second (\*)

Accuracy: . Thermocouples J, K, T: 0,25 % of the span  $\pm 1$  °C (\*\*)

.....Pt100: 0,2 % of the span

Input Impedance:.....Pt100 and thermocouples: > 10 M $\Omega$

Measurement of Pt100: ..... 3-wire type, ( $\alpha=0.00385$ )

With compensation for cable length, excitation current of 0.170 mA.

(\*) Value adopted when the Digital Filter parameter is set to 0 (zero) value. For Digital Filter values other than 0, the Input Reading Rate value is 5 samples per second.

(\*\*) the use of thermocouples requires a minimum time interval of 15 minutes for stabilization.

**OUTPUTS:**

OUT1: .....Voltage pulse, 5 V / 25 mA  
 OUT2: .....Relay SPST; 1.5 A / 240 Vac / 30 Vdc  
 OUT3: .....Relay SPST; 1.5 A / 240 Vac / 30 Vdc  
 OUT4: .....Relay SPDT; 3 A / 240 Vac / 30 Vdc

**FRONT PANEL:** ..... IP65, Polycarbonate (PC) UL94 V-2

**ENCLOSURE:** ..... IP20, ABS+PC UL94 V-0

**ELECTROMAGNETIC COMPATIBILITY:** ..... EN 61326-1:1997  
 and EN 61326-1/A1:1998

**EMISSION:** ..... CISPR11/EN55011

**IMMUNITY:** ..... EN61000-4-2, EN61000-4-3, EN61000-4-4,  
 EN61000-4-5, EN61000-4-6, EN61000-4-8 and EN61000-4-11

**SAFETY:** ..... EN61010-1:1993 and EN61010-1/A2:1995

**SPECIFIC CONNECTIONS FOR TYPE FORK TERMINALS;**

**PROGRAMMABLE CYCLE OF PWM:** From 0.5 up 100 seconds.

**STARTS UP OPERATION:** After 3 seconds connected to the power supply.

**CERTIFICATION:**  and .

**SAFETY INFORMATION**

Any control system design should take into account that any part of the system has the potential to fail. This product is not a protection or safety device and its alarms are not intended to protect against product failures. Independent safety devices should be always provided if personnel or property are at risk.

Product performance and specifications may be affected by its environment and installation. It's user's responsibility to assure proper grounding, shielding, cable routing and electrical noise filtering, in accordance with local regulations, EMC standards and good installation practices.

**SUPPORT AND MAINTENANCE**

This product contains no serviceable parts inside. Contact our local distributor in case you need authorized service.

**LIMITED WARRANTY AND LIMITATION OF LIABILITY**

NOVUS warrants to the original purchaser that this product is free from defects in material and workmanship under normal use and service within one (1) year from the date of shipment from factory or from its official sales channel to the original purchaser.

NOVUS liability under this warranty shall not in any case exceed the cost of correcting defects in the product or of supplying replacement product as herein provided and upon the expiration of the warranty period all such liability shall terminate.

For complete information on warranty and liability limitations, check appropriate section in our website: [www.novusautomation.com/warranty](http://www.novusautomation.com/warranty).