

ApexZ

AIRBORNE PARTICLE COUNTER



Operators Manual

Blank Page

Lighthouse Worldwide Solutions

ApexZ3 and ApexZ50 Airborne Particle Counters



Operators Manual

Copyright ©2018 by Lighthouse Worldwide Solutions. All rights reserved. No part of this document may be reproduced by any means except as permitted in writing by Lighthouse Worldwide Solutions.

The information contained herein constitutes valuable trade secrets of Lighthouse Worldwide Solutions. You are not permitted to disclose or allow to be disclosed such information except as permitted in writing by Lighthouse Worldwide Solutions.

The information contained herein is subject to change without notice. Lighthouse Worldwide Solutions is not responsible for any damages arising out of your use of the LMS program.

LMS™, LMS XChange™, ApexZ™, ApexZ3™, ApexZ50™ are trademarks of Lighthouse Worldwide Solutions. Microsoft®, Microsoft Windows™ are trademarks of Microsoft Corporation.

Manufactured by:
Lighthouse Worldwide Solutions
1221 Disk Drive
Medford, Oregon 97501

LWS Part Number: 248083466-1 R9

Table of Contents

Safety.....	1
About this Manual.....	1
General Safety.....	1
Installing the battery.....	4
Compliance.....	9
FCC Notice.....	9
CE Notice.....	10
Introduction.....	11
Overview.....	11
Specifications.....	12
Enclosure and Ports – ApexZ3.....	13
Enclosure and Ports - ApexZ50.....	14
Optional Printer.....	15
LED Handle*.....	17
Operating ApexZ.....	19
Sample Settings Dashboard.....	20
Manual Sample.....	21
Sample Settings.....	21
Channel Settings.....	21
Save Manual Sample.....	22
Start Manual Sample.....	22
Preset Samples.....	23
Assign Preset to Location.....	23
Start Preset Sampling.....	24
Sample Plans.....	25
Select a Sample Plan.....	26
Select a Location.....	26
Save Sample Plan.....	26
Certification Sample.....	27
Quick Certification.....	29
View Options.....	30
Data Table View.....	30

Sample Grid View	32
Histogram View	35
Graph View	36
Environmental View	37
Sampling with Data Tags	38
Data Screen	41
View Data Records.....	41
Status Bar.....	43
Data Tags	44
Export Data Records	45
Make Report from Data Records.....	46
Filter Data Records	49
Delete all data records	55
Reports	56
Report Screen	56
Filter Report List	58
Export Report	60
Delete a Report.....	61
Audit Trail	62
Settings	63
Instrument Settings	65
Time & Date.....	66
Set Current Date	66
Set Current Time.....	69
Audio/Visual	70
Volume	70
Brightness	70
Language.....	70
Decimal Mark.....	70
Digit Grouping.....	70
Options	71
Lock Global Channels.....	71
Tool Tips.....	72
User Options	73

Sample Options	75
Zero Count Options	75
Data Tag Name Options.....	77
Output	82
USB	82
Print	82
CIFS	84
Formatting.....	85
Configuration.....	88
Save ApexZ configuration file to USB key.....	88
Load ApexZ configuration file from a USB key	89
Connectivity.....	91
LMS XChange Software 2.x.....	91
Ethernet.....	92
Wi-Fi.....	95
Active Directory AD/LDAP	99
CIFS -Common Internet File System	101
3 rd Party API - Application Programing Interface	103
Locations and Groups.....	105
View Locations.....	105
Create New Locations.....	106
Edit a Location	107
Delete a Location.....	108
Add a New Group	109
Assign Locations to a new Group	110
Edit a Group.....	112
Delete a Group	113
Presets	115
Add a Preset	115
Enter Preset Sample Settings.	116
Edit Channel.....	117
Enter Warning and Alarm settings	117
Assign Locations to the New Preset	118
Preset Name	118

Locations linked to Presets.....	119
Sample Plans.....	121
Add New Sample Plan	121
Preset - Sample Settings.....	127
Delete Sample Plan.....	133
Certifications	135
Add a Certification.....	135
Certification Types.....	135
Edit a Certification	144
Delete a Certification.....	145
Users & Permission Levels.....	147
Users.....	147
Add a New User	148
Edit User	151
Delete a User	152
User Login	153
User Logout	154
Administrator Permission Level	155
Add new Permission Level.....	155
Edit Permission Levels	156
Assign AD Group to Permission Level.....	157
Prioritize Permission Levels.....	159
Service	161
Maintenance.....	161
About Screen	164
Service Login.....	165
Calibration	167
Trouble Shooting	169
Clean and Disinfect.....	171
Terminology.....	173
Appendix A: Limited Warranty	175

*Patent Pending

Safety

About this Manual

This manual describes the setup, operation and use of the Lighthouse Worldwide Solutions ApexZ family of Portable Airborne Particle Counters. The word “ApexZ”, “unit” or “instrument” may be used in place of a specific model in this ApexZ Operators Manual.

General Safety

Warnings and cautions are used throughout this manual and the reader should become familiar with the meaning of a warning before operating the particle counter. Most warnings will appear next to the subject or step to which it applies. Take care when performing any procedures preceded by or containing a warning. The classifications of warning are defined as follows:

- Laser – pertaining to exposure to visible or invisible LASER radiation.
- Electrostatic – pertaining to electrostatic discharge.
- Network Connection – pertaining to communication ports and instrument damage.

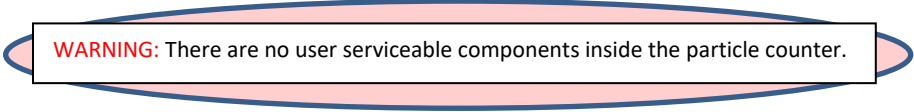

WARNING: There are no user serviceable components inside the particle counter.

Laser Safety

This product is considered to be a Class 1 LASER product (as defined by FDA 21 CFR, §1040.10 and IEC 60825-1:2014) when used under normal operation and maintenance. Performing service on the internal sensor can, however, result in exposure to invisible radiation. The particle counter has been evaluated and tested in accordance with EN 61010-1:2012, "Safety Requirements for Electrical Equipment for Measurement, Control and Laboratory Use" and IEC 60825-1:2014, "Safety of LASER Products". For further technical assistance, contact our Technical Support Team at 1-800-945-5905 (USA Toll Free), or 1-541-770-5905.



Laser Warning Label

WARNING: There are no user-serviceable components inside the particle counter. The use of controls, adjustments or procedures other than those specified within this manual may result in personal injury and/or damage to this instrument.

Battery Safety

Battery Type:

National Power Sm-Energy®

Model: SM221

Lithium-Ion Rechargeable Battery, 14.4V, 6.45Ah, 93Wh



Battery Level Indicator Button

Press here to display blue LED battery charge level 25-50-75-100%

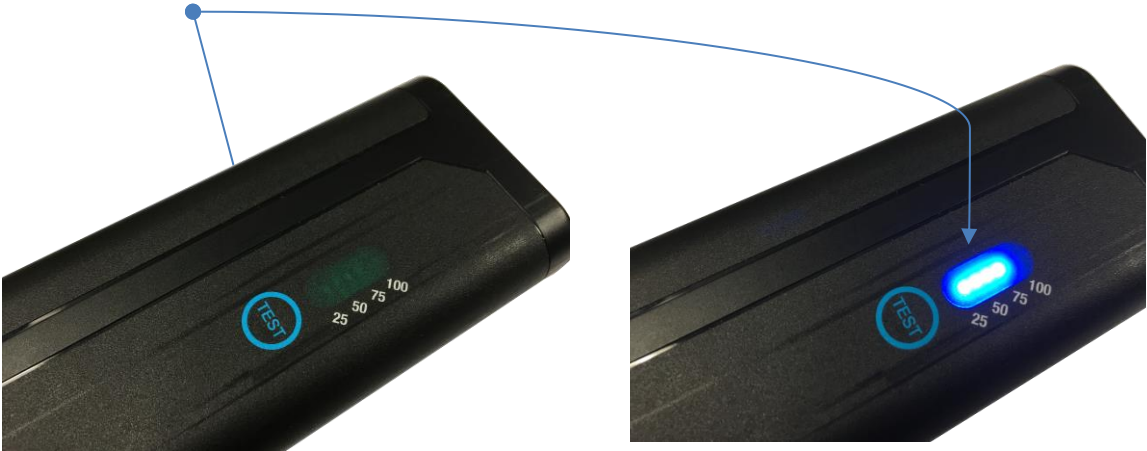

Installing the battery

Insert **battery 1** into the lower battery slot.

Note: ApexZ has dual battery slots and can operate with either one or two batteries installed. With two batteries installed both batteries will self-adjust and drain their charge evenly together.



Insert **battery 2** into the upper battery bay. You will feel a slight pressure and clicking as the battery seats down fully in the battery bay.



Close the battery door.
Tighten down the battery door screw.



Hot swapping the batteries

ApexZ will allow the user to remove one battery while the instrument is powered on and sampling. This allows the user to continue to sample with one battery while recharging the second battery. A charged second battery may then be reinstalled into the instrument while ApexZ is still sampling.

Hot swapping allows the user to install a newly charged battery and then remove a low charged battery while the instrument is sampling under battery power.

Use the optional battery charger (part #: 017789752 single battery charger, or part #: 017789753 dual battery charger) to charge batteries outside of the ApexZ instrument.

Batteries inserted into ApexZ will always charge while ApexZ is plugged into the AC power with the AC power adapter and power cord.



WARNING: Only use batteries provided with the ApexZ by Lighthouse Worldwide Solutions. Use of unauthorized batteries may cause damage to equipment, void warranty, and pose a threat to safety.

Charging the batteries outside of ApexZ

Optional Dual Bay Desktop Charger for charging up to 2 ApexZ batteries at the same time. Batteries not included.



Power Safety

Start Up

Press the power button to turn on the ApexZ particle counter.

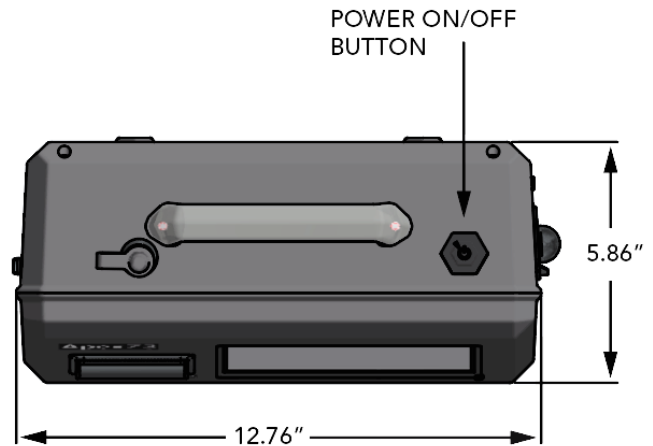

Shut Down

To shut down press the power button once. DO NOT HOLD the power button down.



Users are not required to logout before ApexZ is shut down. If Users are enabled, shutting down the ApexZ will logout the current user and will require a user to login when the ApexZ is next started. It is permissible to shut down the ApexZ particle counter from any one of the user interface screens.

WARNING: Do not press and hold the Power button to shut down. This will cause a hard reset and is not recommended.

WARNING: If the ApexZ is shut down during a sample, that sample will not be completed or saved.

Sampling Safety

WARNING: While the flow path components will not be adversely affected, sampling reactive gasses such as hydrogen and oxygen can be dangerous. Appropriate precautions should be taken. Sampling of any pressurized gasses without the use of properly designed diffuser can cause damage to the instrument and void the warranty. DO NOT allow water, solvents, or other liquids to enter the instrument, as they can damage the instrument and void the warranty.

Operating Safety

WARNING: The use of controls, adjustments or procedures other than those specified within this manual may result in personal injury and/or damage to this instrument. Attempts by untrained personnel to disassemble, alter, modify or adjust the electronics or optics may result in personal injury and damage to the instrument and will void its warranty. There are no user-serviceable components inside the particle counter. Only factory authorized service personnel should repair or service this instrument and its optical system. If replacement of the power supply or its AC power cord is required, replace it only with a power supply or cord having as good as or better ratings than specifications provided by Lighthouse Worldwide Solutions. Attempting to use an under-rated power supply or cord can expose the instrument and adjacent equipment to the user to dangerous shock and fire hazards. Failure to meet this requirement will void the CE certification, void the instrument warranty and can result in serious personal injury.

Electrostatic Safety Information

WARNING: Electrostatic discharge (ESD) can damage or destroy electronic components. Therefore, any service or maintenance work should be done at a static-free work station. A static-free work station requires an ESD consultant to evaluate the work environment and propose the equipment and apparel needed for a work station to be successful.

Blank Page

Compliance

FCC Notice



This device complies with Part 15 of the FCC Rules. Operation is subject to the following two conditions: (1) this device may not cause harmful interference, and (2) this device must accept any interference received, including interference that may cause undesired operation.

Class A Digital Devices

NOTE: This equipment has been tested and found to comply with the limits for a Class A digital device, pursuant to Part 15 of the FCC Rules. These limits are designed to provide reasonable protection against harmful interference when the equipment is operated in a commercial environment. This equipment generates, uses, and can radiate radio frequency energy and, if not installed and used in accordance with the instruction manual, may cause harmful interference to radio communications. Operation of this equipment in a residential area is likely to cause harmful interference in which case the user will be required to correct the interference at his expense.

NOTE: Any changes or modifications not expressly approved by Lighthouse Worldwide Solutions could void your authority to operate this equipment.

FCC RF Exposure Statement

This equipment complies with FCC RF exposure limits set forth for an uncontrolled environment. This equipment was verified for RF exposure and found to comply with FCC OET-65 RF exposure requirements.

WARNING: Making changes to the antenna or the equipment is not permitted. Doing so may result in the equipment exceeding the FCC RF exposure guidelines. This equipment must not be co-located or operated in conjunction with any other antenna or radio transmitter.

CE Notice

CE

EU CE DECLARATION OF CONFORMITY

Manufacturer's Name: Lighthouse Worldwide Solutions, Inc.

Manufacturer's Address: Lighthouse Worldwide Solutions, Inc.
1221 Disk Drive
Medford, OR 97501 USA

Declares the product:

Product Name: ApexZ
Model Number(s): ApexZ3, ApexZ50

Conforms to the Following Harmonized Standards:

<u>SAFETY:</u>	IEC 61010-1:2010 3 rd Ed.	Safety Requirements for Electrical Equipment for Measurement, Control, and Laboratory Use Part 1: General Requirements
<u>EMC:</u>	2014/53/EU	Radio Equipment Directive (RED) EN 301 489-1, Common technical requirements EN 301 489-17, Specific conditions for Broadband Data Transmission Systems EN 300 328, Data transmission equipment operating in the 2.4 GHz ISM band and using wide band modulation techniques
	EN 61326-1:2013	Electrical Equipment for Measurement, Control and Laboratory Use

Supplementary information

This declaration of conformity is issued under the sole responsibility of the manufacturer.

2017-09-22, Medford OR, USA

Date / Location Issued

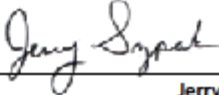

Jerry Szpak
VP of Engineering

Introduction

Overview

This operating manual introduces the Lighthouse **ApexZ** portable particle counters ApexZ3 and ApexZ50 and includes instructions for inspecting, installing, using and maintaining the instrument.



ApexZ3



ApexZ50

Description

The ApexZ portable particle counter comes standard with 6 particle-size channels (ApexZ3: 0.3, 0.5, 1.0, 3.0, 5.0, 10.0 microns), (ApexZ50: 0.5, 0.7, 1.0, 3.0, 5.0, 10.0 microns) and a flow rate of (ApexZ3: 1.0 CFM), (ApexZ50: 100LPM). The instrument uses a LASER diode light source and LASER beam shaping optics to illuminate a cross section of the air flow path. As particles move along this path, they cross the LASER beam and scatter light. The scattered light rays from particles cutting through the beam are steered to a photodiode using a system of collection optics. The photodiode converts the image into a current which is converted to a voltage and amplified by an electronic circuit. The amplitude of the voltage pulse is proportional to the light scattered, which in turn is proportional to the size of the particle. The voltage pulses created by the particle are then processed by additional electronics that analyze the height of each pulse and therefore, the size of each corresponding particle. The result is that the number of particles of various sizes is determined. The ApexZ is effective in both ultra-clean areas (such as ISO Class 2 or Grade A) and in more traditional clean zones rated as ISO Class 3 or higher. Refer to Specifications in this manual for additional instrument information.

Accessories Included

ApexZ Includes: USB flash drive with lanyard (includes ApexZ3/ApexZ5 Read Me First and Operators Manual), ISO probe (ApexZ3: 1 CFM, ApexZ50 100 LPM), Zero count filter (ApexZ3 1 CFM fittings, ApexZ50 100 LPM fittings), USB to Micro-B cable, Exhaust Barb, Printed Instrument Read-Me-First, 10ft Bev-A-Line sample tubing, 24 VDC 5.0 amp power adapter and power cord, 1 Li-Ion Smart battery (2 battery slot capacity), 2x rolls of printer paper (units with printers only), Calibration certificate, Software Download Instructions.

Specifications

Size Range	ApexZ3: 0.3 - 10.0 µm. ApexZ50: 0.5 – 10.0 µm.
Standard 6 Channels	ApexZ3: 0.3, 0.5, 1.0, 3.0, 5.0, 10.0 µm. ApexZ50: 0.5, 0.7, 1.0, 3.0, 5.0, 10.0 µm.
Flow rate	ApexZ3: 1.0 CFM (28.3 LPM). ApexZ50: 100 LPM.
Laser Source	Laser Diode.
Zero Count Level	< 1 count / 5 minutes (meets specifications of JIS B 9921 and reporting requirements of ISO 21501-4 Annex C).
Concentration Limits	ApexZ3: 1,000,000 particles / ft ³ @ 10% coincidence loss. ApexZ50: 300,000 particles / ft ³ @ 10% coincidence loss.
Counting Efficiency	ApexZ3: 50% @ 0.3 µm, 100% for particles > 1.5x first channel particle size. ApexZ50 50% @ 0.5 µm, 100% for particles > 1.5x first channel particle size.
Calibration	Designed for ISO 21501-4 compliance.
Self-Diagnostics	Laser power/current/supply, flow out-of-range, no flow, PA background/supply/health.
Count Modes	Sample, Concentration, Beep.
Data Storage	10,000 sample records, 2500 locations, 250 Groups, 500 Presets, 500 Sample Plans, 500 Certifications, 10 Permission levels, 100 reports, and 1000 users.
Communication	Ethernet, Wi-Fi (802.11 b/g/n), USB key.
Supporting Software	LMS XChange 2.x
Environmental Sensors	Temperature/Relative Humidity probe: 32-122 °F (0-50 °C) ± 1 °F (0.5 °C), 15%-90% ± 2% RH.
Touch Screen Display	7.0 inch (8.89 cm), 1200 x 800 IPS color touch screen.
Speakers	2x adjustable speakers up to 70 dB to indicate status and alerts.
Carry Handle	With RGB LED's for status and alarms.
Printer	Optional embedded panel-mount printer.
Reports	FED-209E, ISO-14644-1:1999, ISO-14644-1:2015 and EU GMP regulatory pass/fail reports displayed on screen or printed.
Alert	User configurable warnings and alarms.
Sample Inlet	ApexZ3: 3/8 inch Inlet nozzle. ApexZ50: 1/2 inch inlet nozzle.
Sample Output	Internally filtered to HEPA standard (>99.97% @ 0.3 µm); with rotatable exhaust fitting for directed flow.
Vacuum Source	Internal blower, automatic flow control.
Enclosure	Chemically Resistant Polycarbonate blend, conductive lining, VHP compatible.
Power	External power supply: 24 VDC, 5 A max draw.
Battery	2x Li-Ion battery capacity, removable and rechargeable.
Battery Run Time	ApexZ3: 2 batteries 11 hours nominal use, 50% duty cycle no printing. ApexZ50: 2 batteries 8 hours nominal use, 50% duty cycle no printing.
Dimensions	12.76" (l) x 6.23" (w) x 8.88" (h), [32.41 x 15.82 x 22.55 cm].
Temperature Range	(50°F - 104°F) (10°C - 40°C), 20% - 95% relative humidity, non-condensing.
Weight	7.05 lbs. (3.19 kg) without batteries, battery weight 1.35 lbs. (0.61 kg).
Languages	English, Spanish, Portuguese, Dutch, French, Italian, Russian, Chinese, Korean, Japanese, Turkish, Thai.

Enclosure and Ports – ApexZ3

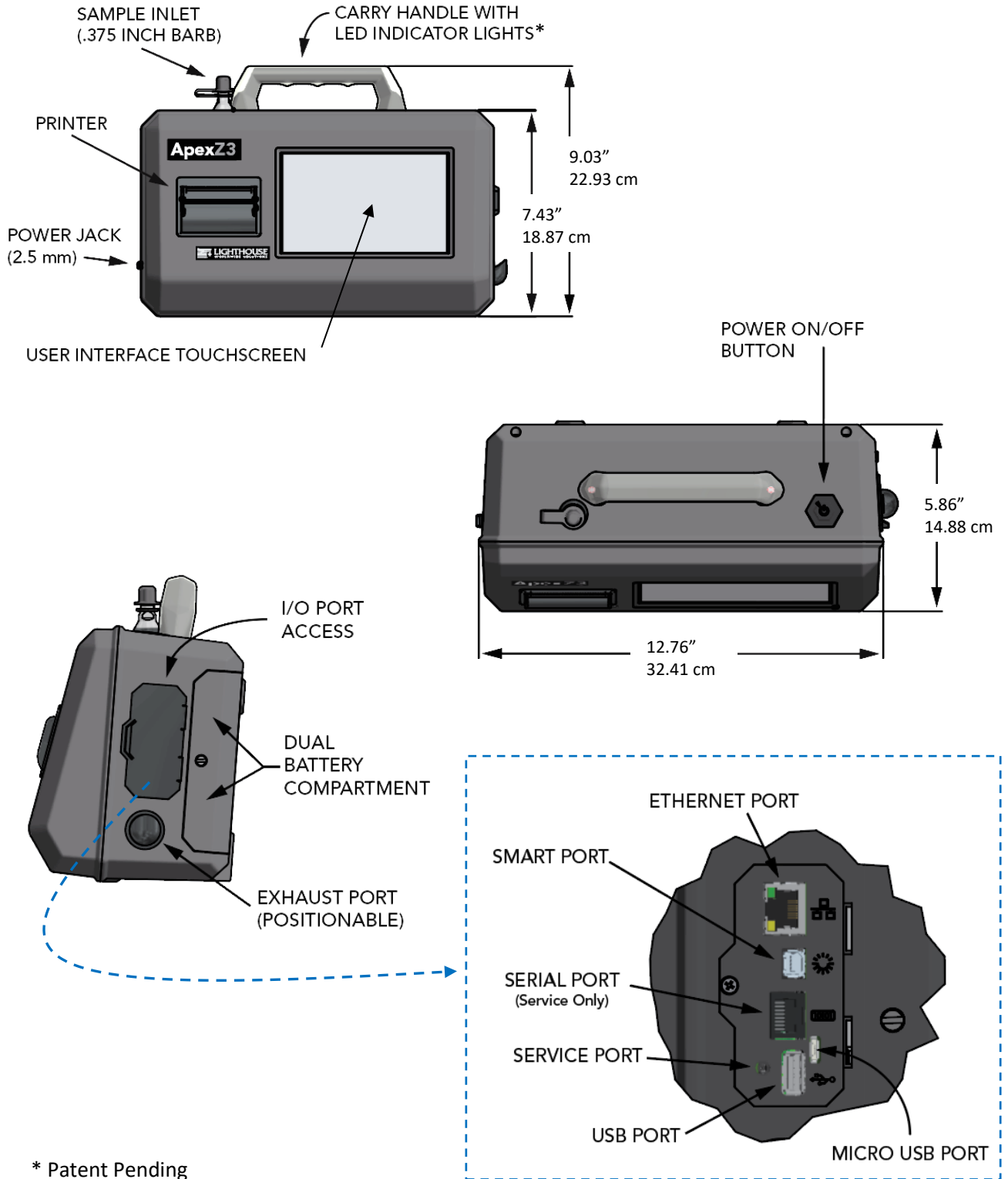

* Patent Pending

Enclosure and Ports - ApexZ50

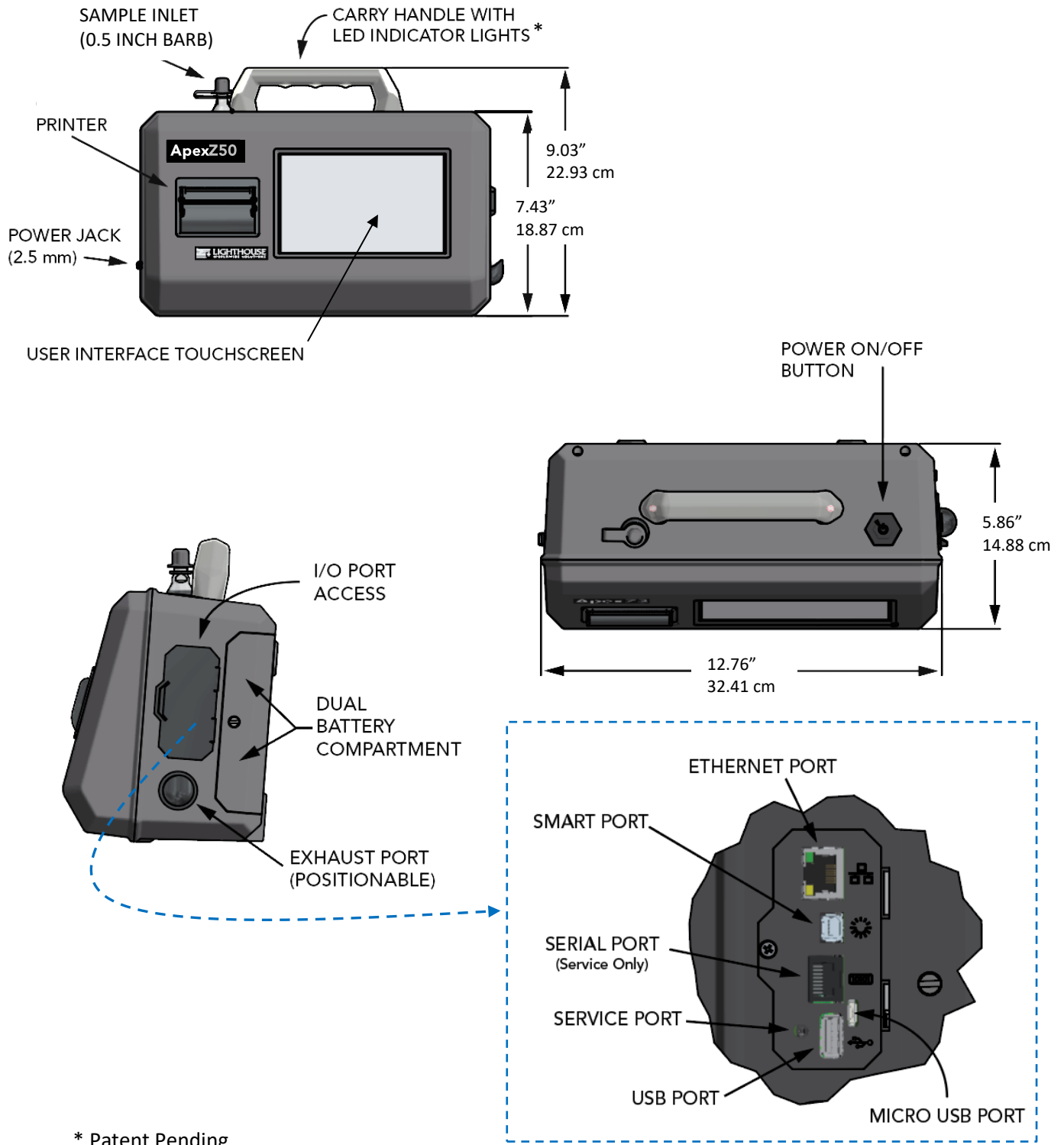

* Patent Pending

Optional Printer

Load Printer Paper

Open Printer Door

Pinch the left and right printer door tabs and gently pull open the printer door.

Load Printer Paper

Insert the printer paper roll with the paper feeding from the back of the roll.

Close Printer Door

Close the printer door so that the left and right printer door tabs snap shut.

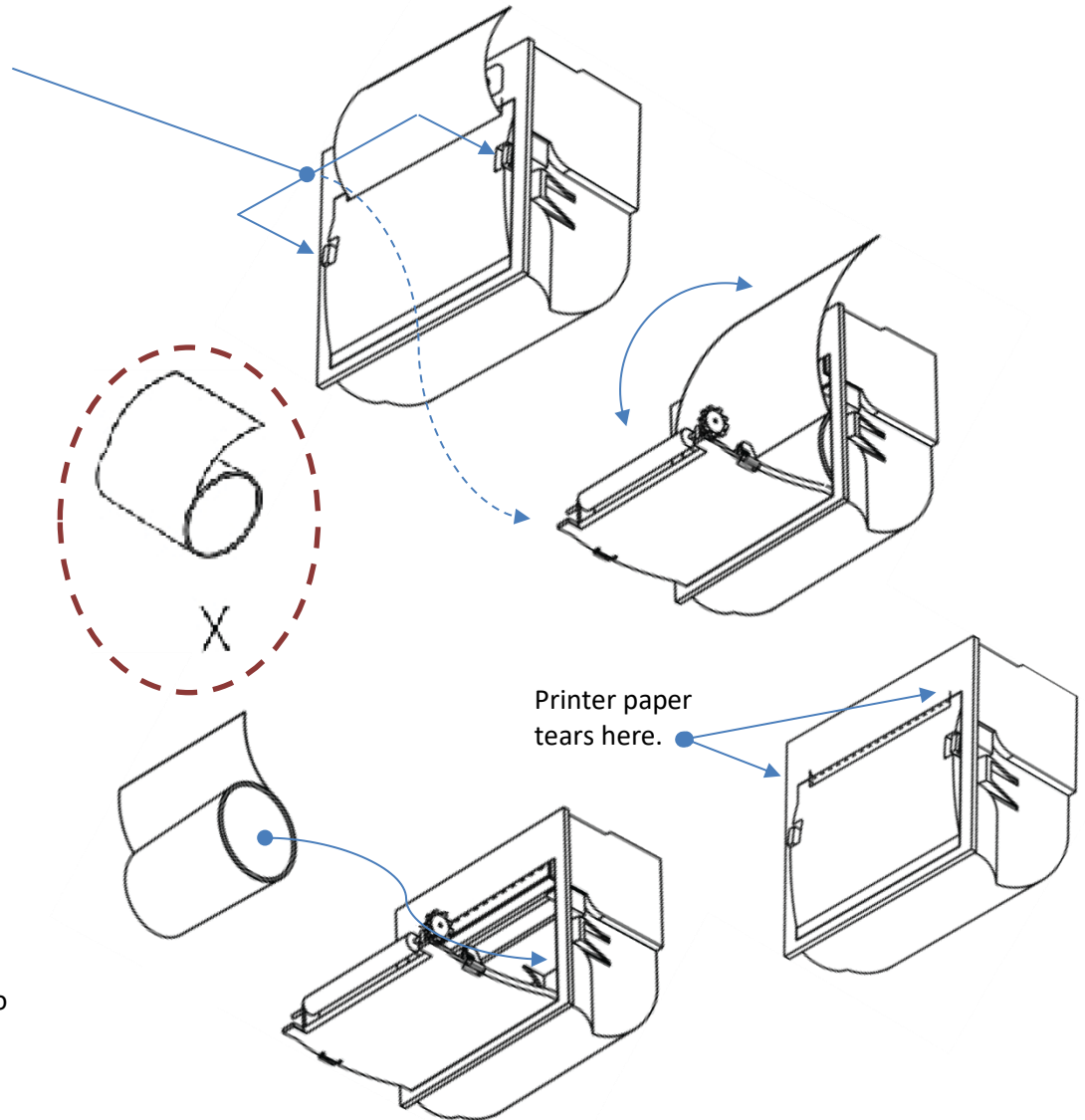

Warning: Changing the instrument language will update the instrument firmware and the printer. It will take 1-2 minutes for the update to complete. During this time make sure the ApexZ instrument has at least 50% battery life remaining or connected to the AC adapter and do not turn off the instrument while updating. Failure to follow these instructions could cause the printer to become damaged and unusable.

Paper Feed

The printer paper feed button is available on the ApexZ:

Home Screen, Data Screen and Report Screen.

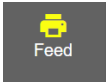

ApexZ Home Screen

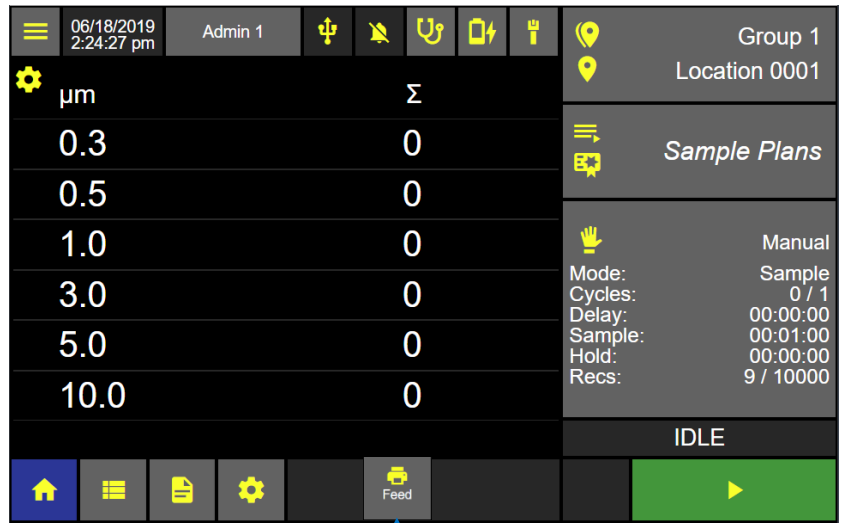

Advance the printer paper

Press the Paper Feed button to advance the paper from the ApexZ embedded printer.

Tear off the printed report

Tear the printed report along the serrated edge of the printer paper opening.

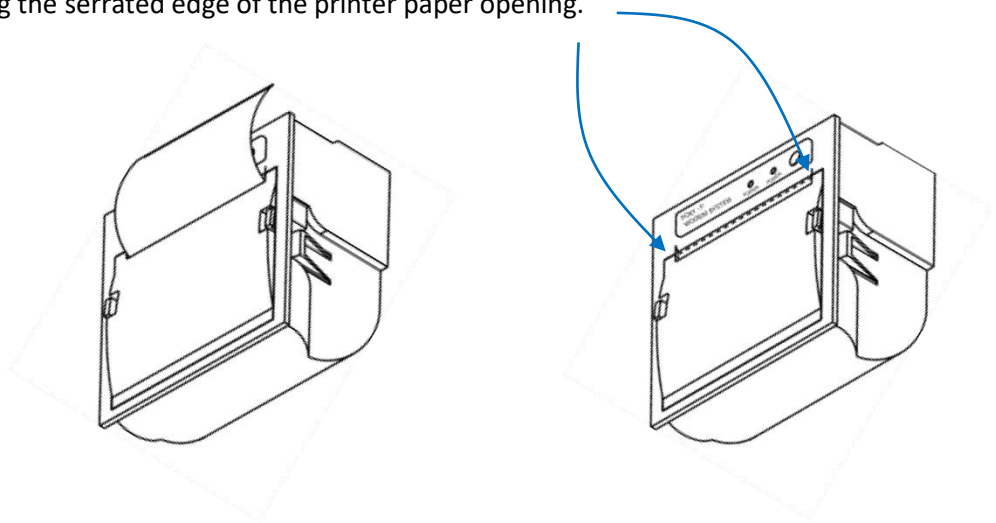

LED Handle*

The ApexZ RGB LED handle lights will light up during and after a sample to indicate warning and alarm status. If the handle LED lights are blinking then the ApexZ is currently sampling. If the handle LED light is a solid color the ApexZ has stopped sampling. The sampling LED color that remains lit after a sample is completed indicates the last recorded warning or alarm condition.

Blinking LED colors indicate ApexZ is **actively sampling**. (Blue also means alarms are disabled)

- **Blinking Blue** actively sampling no instrument faults, (warnings/alarms are disabled).
- **Blinking Green** actively sampling no instrument faults, no warnings, no alarms.
- **Blinking Orange** actively sampling no instrument faults, warning limit has been exceeded.
- **Blinking Red** actively sampling alarm limit exceeded and/or faults detected.

Solid LED color indicates ApexZ is **not currently sampling**.

- **Solid Green** sample completed no warning/alarm limits exceeded, no faults detected.
- **Solid Orange** sample completed warning limit exceeded, no instrument faults detected.
- **Solid Red** sample completed alarm limit exceeded and/or instrument faults detected.



*Patent Pending

Blank Page

Operating ApexZ

This is the Home Screen on the ApexZ airborne particle counter. Create manual or preset sample plans and certifications for up to 2500 unique locations.

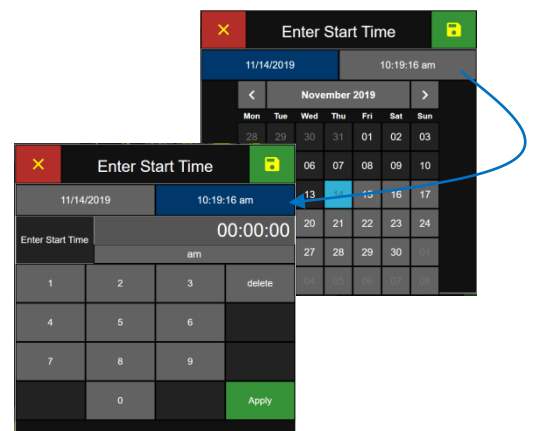
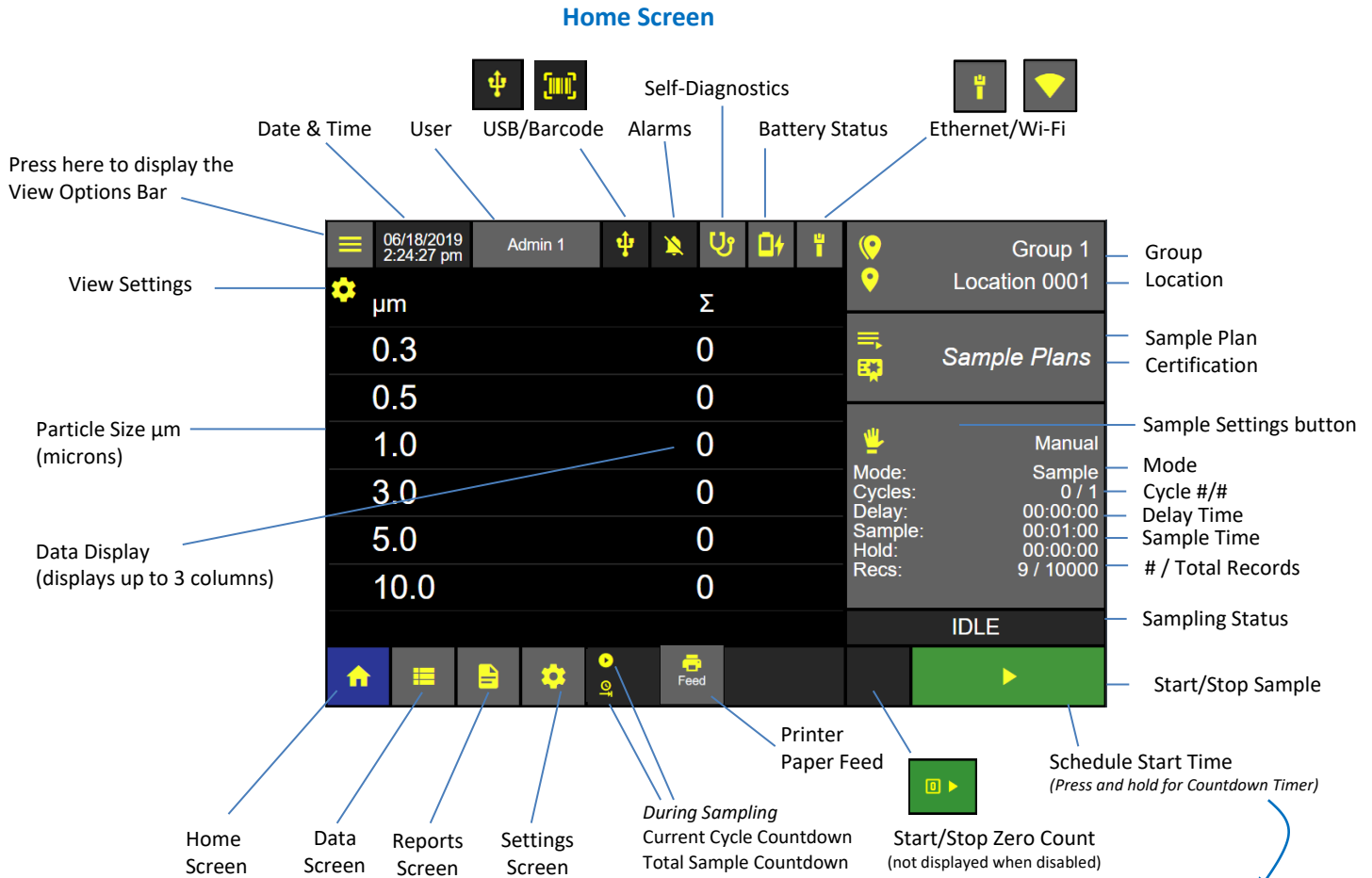

Sample Settings Dashboard

Home Screen

Press the Group/Location button to display the Sample Settings Dashboard.

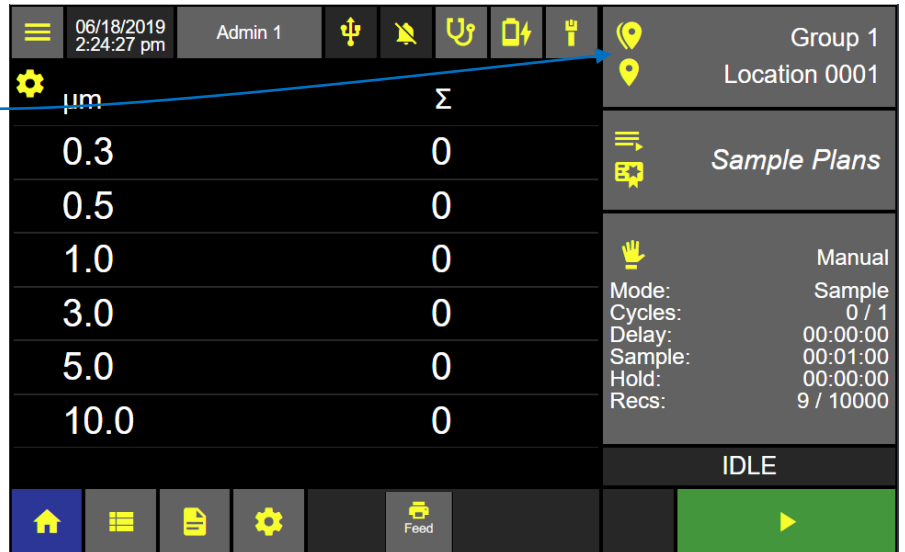

Select the manual sample button.

If no group is selected (no group name is highlighted blue) then all locations will display in the location column. The first location will be selected and highlighted blue.

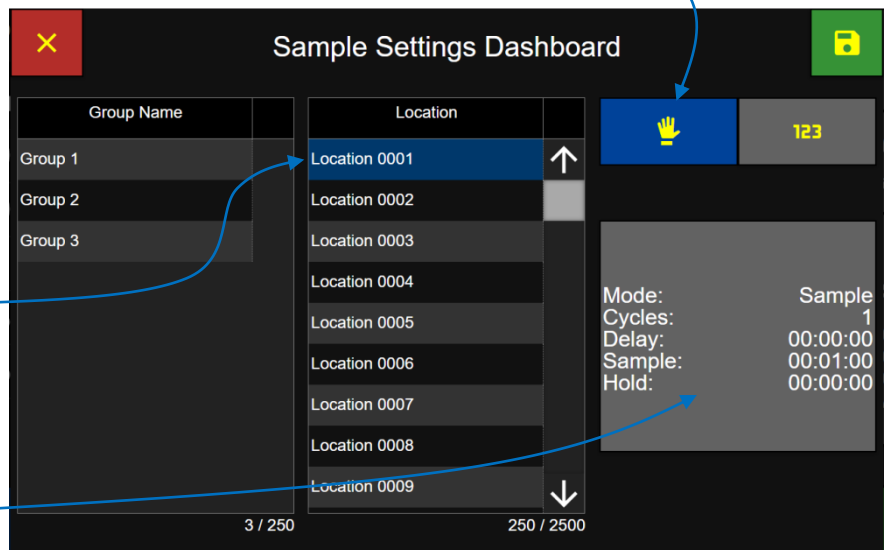

Groups and Locations

Select the location to be sampled.

Edit the Sample Settings

Press the Manual Sample button to edit the sample mode, cycles, delay, sample time and hold time.

Sample Settings Dashboard

Manual Sample

Manual Sample Settings

Sample Settings

Press each sample setting button to edit:

- Mode
- Delay
- Sample Time
- Hold Time
- Cycles #/#
- Units ft³/m³/liters
- Volume

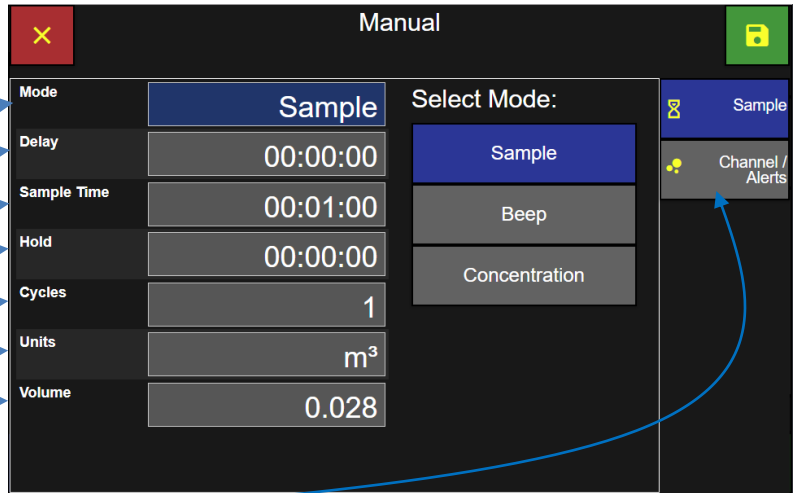

Press the Channel/Alerts button to display the Channel Settings screen.

Channel Settings

Manual Sample - Channel/Alerts

Press any green channel size button to disable that channel and it will highlight grey and strike through indicating it has been disabled. Press again to enable that channel.

Press any Warning or Alarm threshold button to set those channels respective thresholds. Select Enable or Disable. Enter the Warning or Alarm threshold limits respectively. Press Apply.

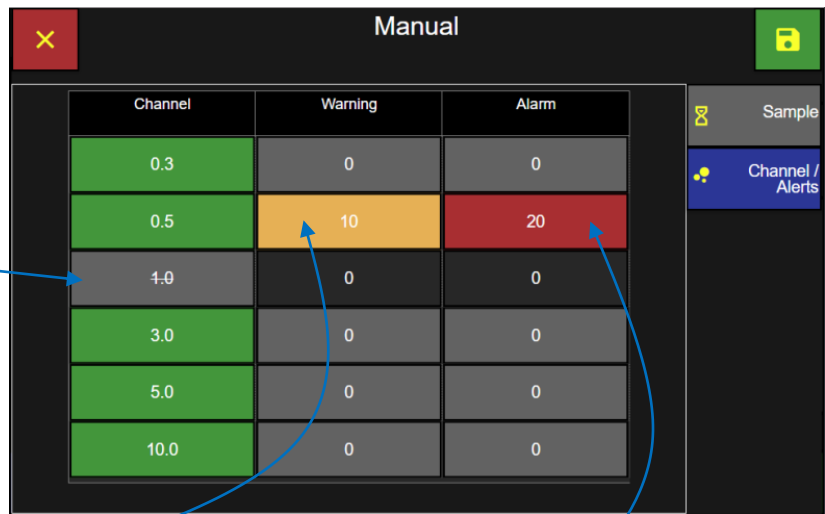

Warning Limit

Alarm Limit

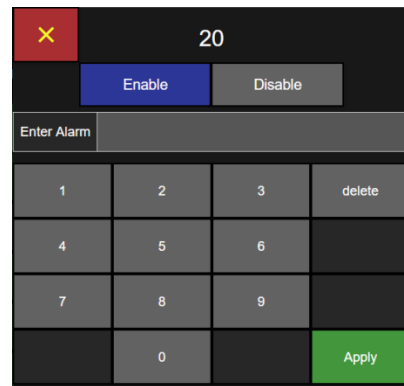
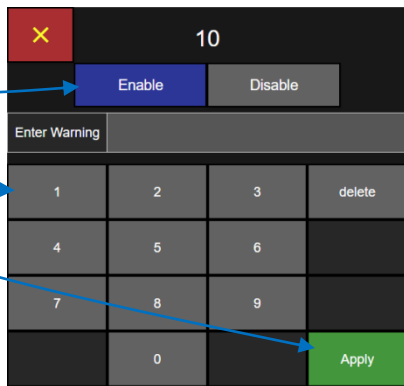

Manual Sample - Channel/Alerts

Save Manual Sample

Press the green Save button to display the Home screen with the manual sample settings.



Home Screen – Manual Sample Loaded

Start Manual Sample

Press the green Start button to start manual sampling when at the selected location.

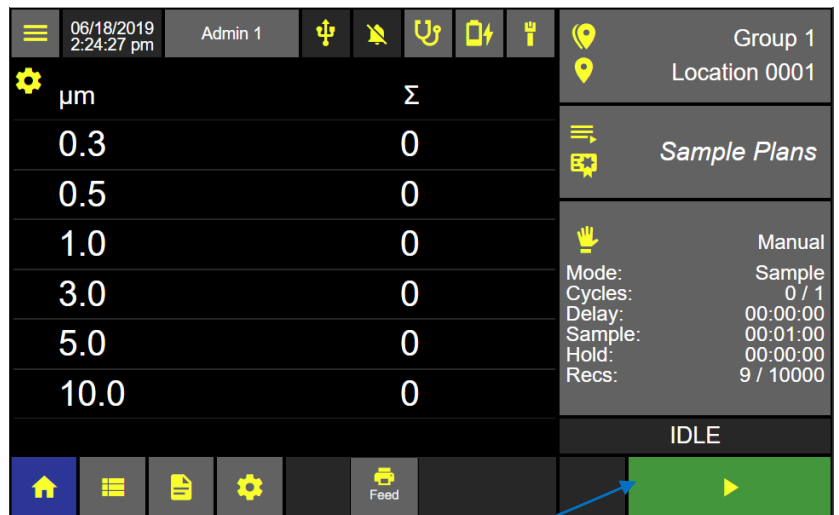

Preset Samples

Preset Sample Dashboard

To run preset sample settings from the Home screen press the Group/Location button to display the Sample Settings Dashboard.

Press the Preset button and it will highlight blue indicating that it has been selected.

All saved preset names will be displayed on the preset name list. Select a group name and only those locations assigned to that group will display on the location list. If no groups are selected then all locations will be displayed.

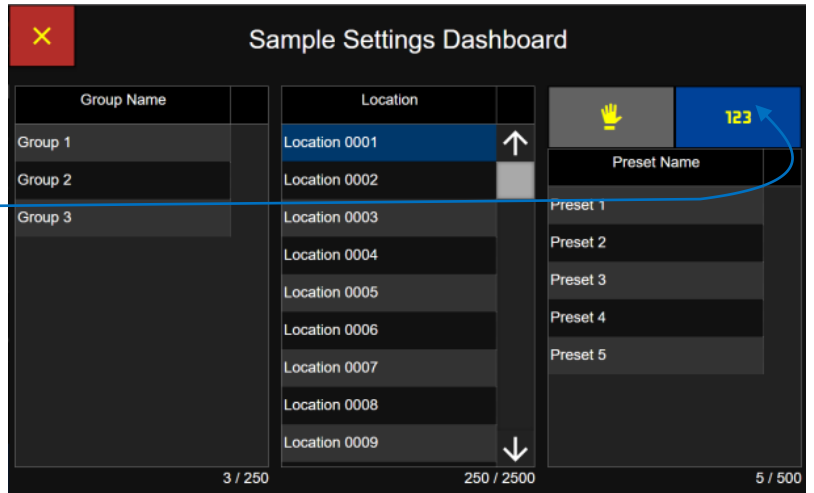

Preset Sample Dashboard

Locations assigned to a preset will appear with the link icon indicated that a preset is currently assigned to that location.

Saved presets will display in the Preset Name column.

Select a location with no linked preset and all presets will be displayed.

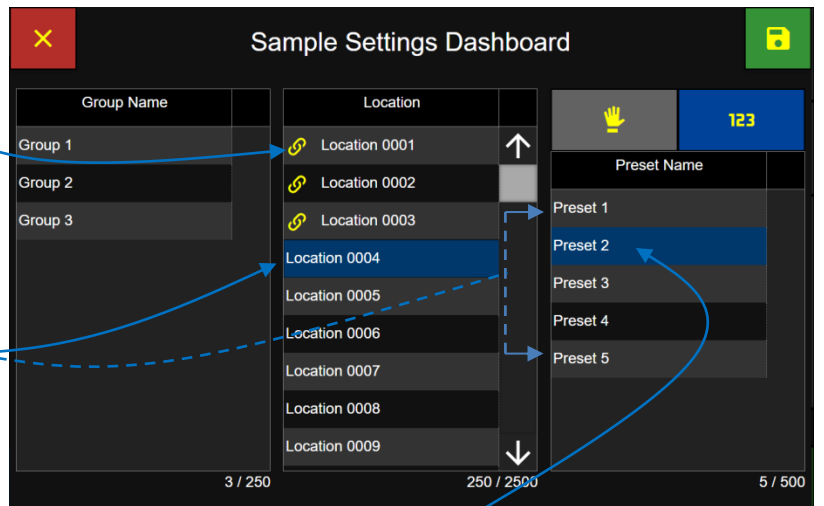

Assign Preset to Location

Select a Preset button and it will highlight blue indicating it has been selected.

Save Preset to Location

Press the green Save button to assign the highlighted preset to the highlighted location.



Start Preset Sampling

The selected Preset Sample Settings will be loaded on the Home screen for the selected location.

Press the Start button to start the sampling preset at the selected location.



Home Screen Ready to Sample

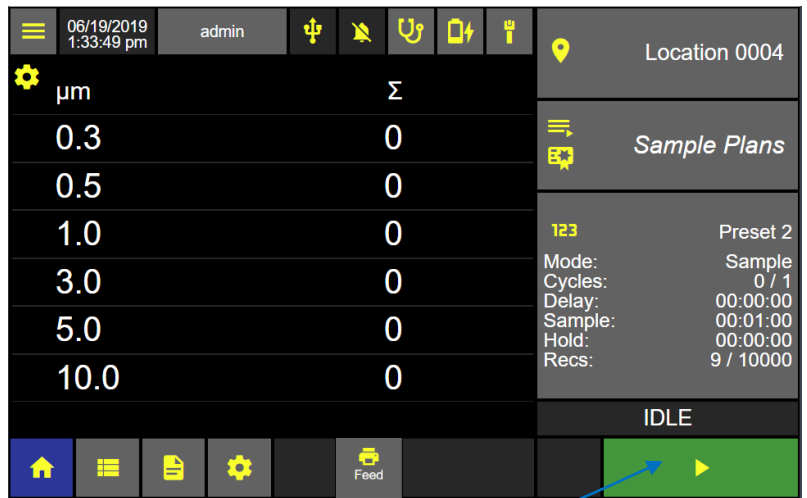

Linked Preset

If a location linked to a preset is selected then only that preset name will be displayed on the preset name list. A location with a linked preset cannot be modified from the Sample Settings Dashboard.

Location linked to Preset

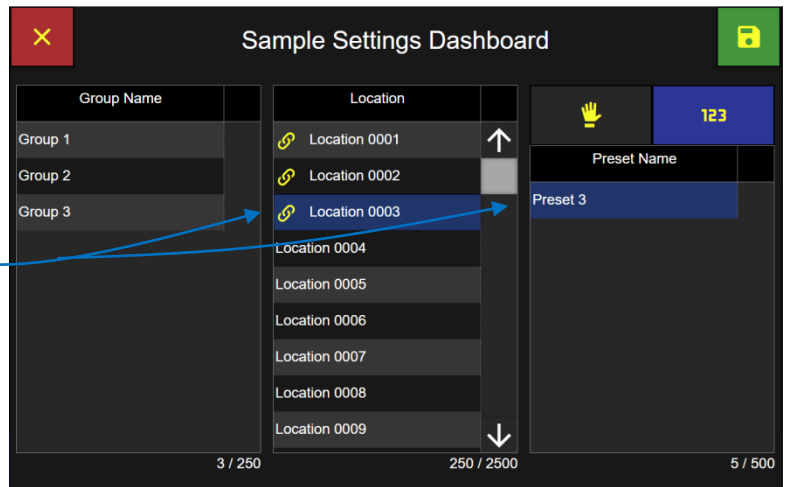

Unlink a preset to a location

To unlink a preset from a location, return to the Settings then Location screen and edit the Preset selection.

Sample Plans

To run a Sample Plan from the Home screen press the Sample Plans/Certifications button to display the Sample Plan/Certification Dashboard.

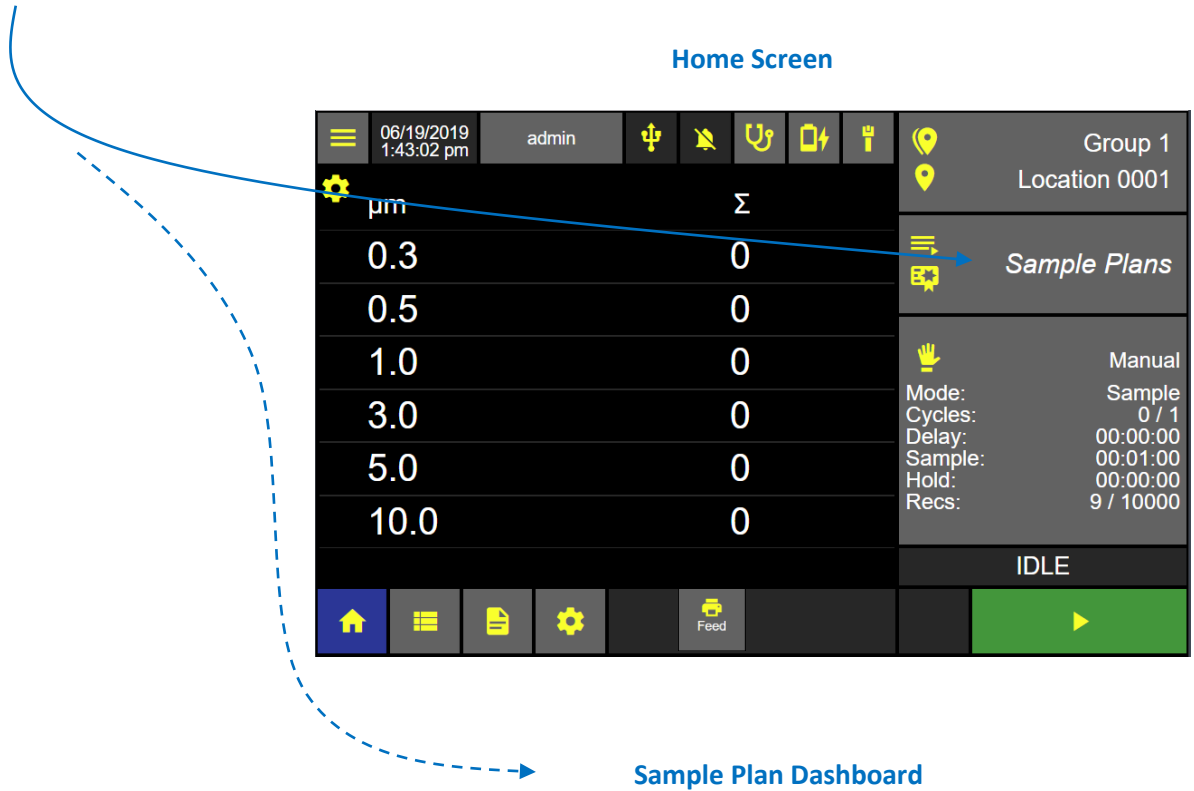

Press the Sample Plan button and it will highlight blue indicating that it has been selected.

The Sample Plan Name list will display all saved sample plans.

When no Sample Plan is selected then all locations will be displayed and selectable.

After a Sample Plan is selected then only those locations assigned to that Sample Plan will be displayed and selectable.

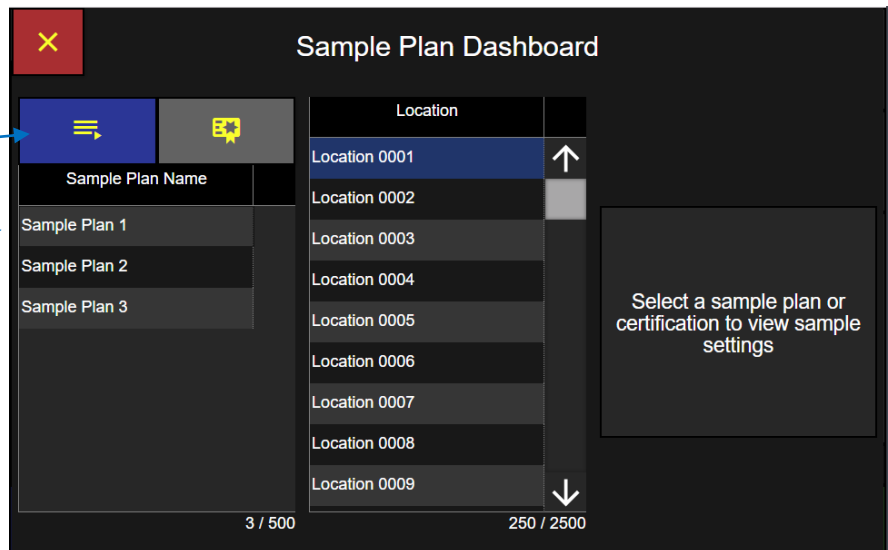

Selecting a Sample Plan and Location

Select a Sample Plan

Select a Sample Plan and it will highlight blue indicating that Sample Plan has been selected.

Locations assigned to that Sample Plan name will display on the Location list.

Select a Location

Select the desired location to be sampled from the Location list and that location will highlight blue indicating it has been selected.

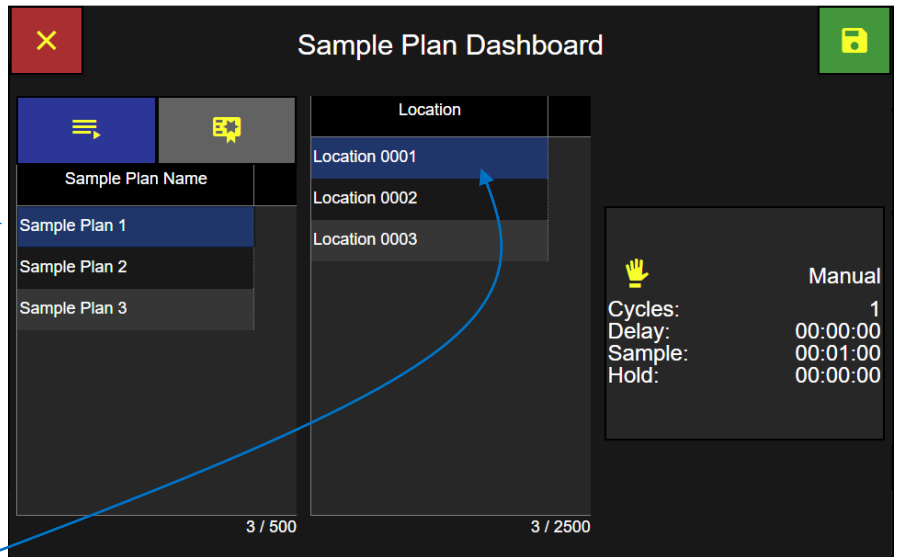

Save Sample Plan

Press the Save button to load the selected Sample Plan and current Location and return to the Home screen.



Sample Plan 1 loaded on the Home Screen

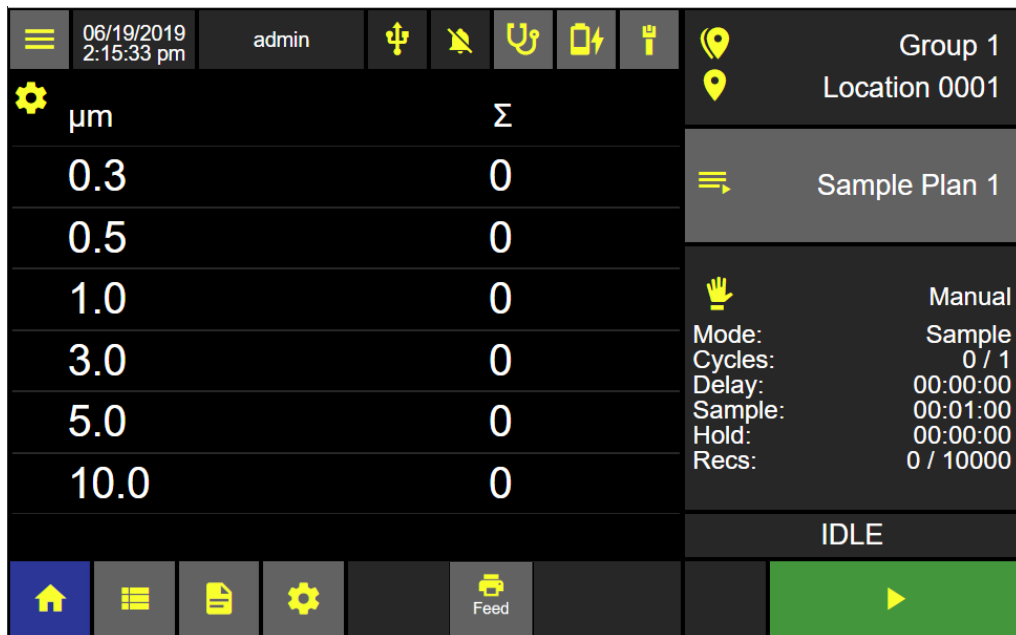

Certification Sample

To run a Certification Sample from the Home screen press the Sample Plans/Certifications button to display the Sample Plan/Certification Dashboard.

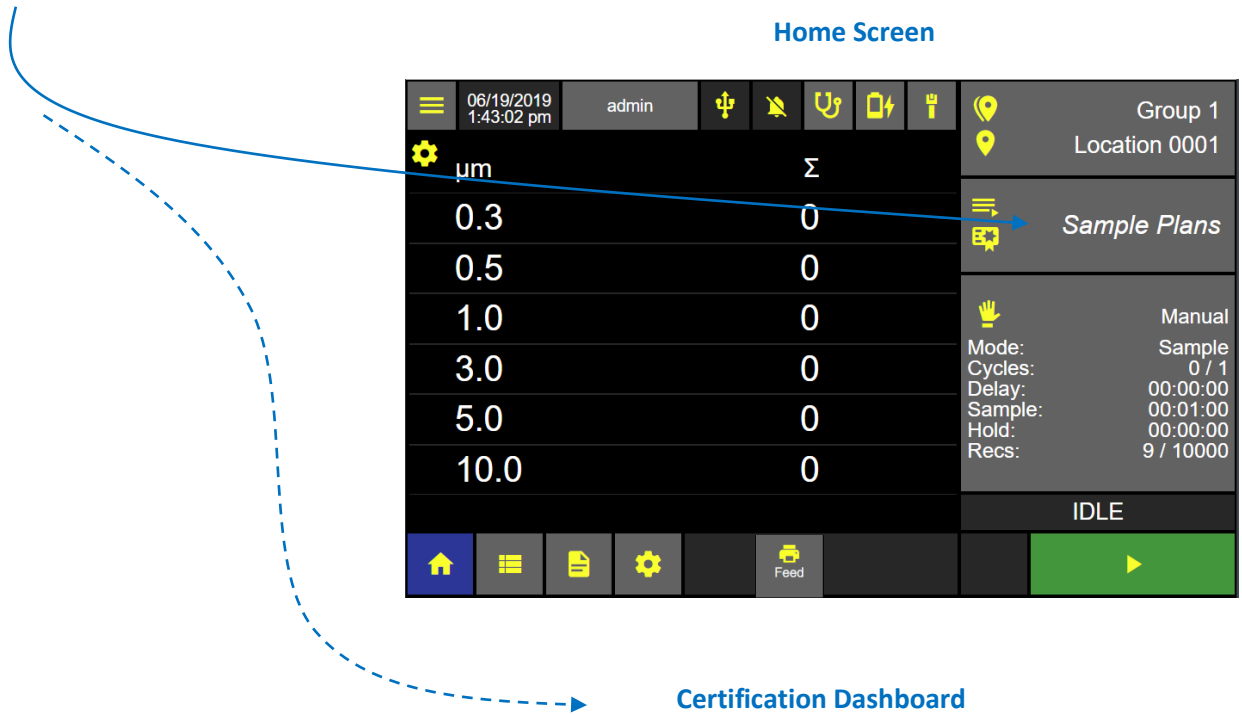

Press the Certification button and it will highlight blue indicating it has been selected.

The Certification Name list will display all saved certifications. When no certification is selected all locations will be displayed and selectable.

After a certification is selected then only those locations assigned to that certification name will be displayed and selectable.

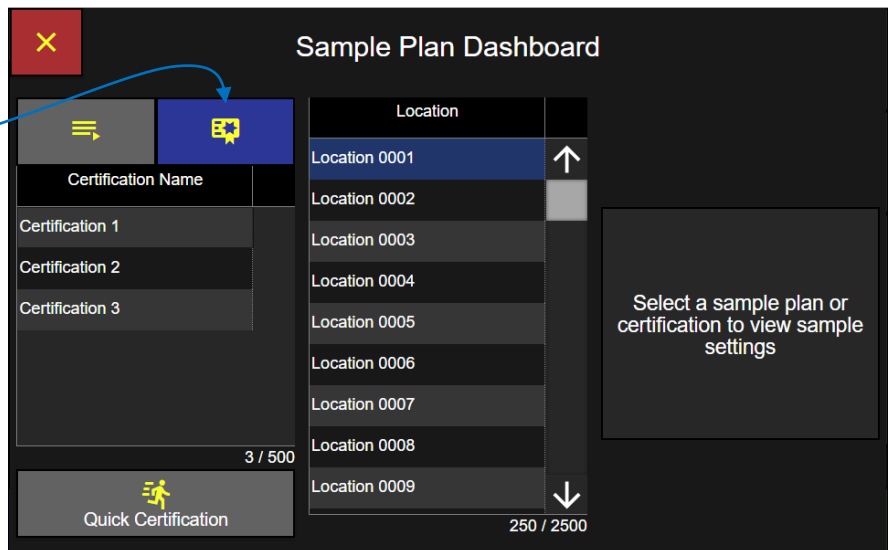

Select a Certification

Select a Certification name and it will highlight blue indicating that it has been selected.

Locations assigned to that certification name will display on the Locations List.

Select a Location

Select the current location to be sampled from the locations list and that location will highlight blue indicating that it has been selected.

Selecting a Certification and Location

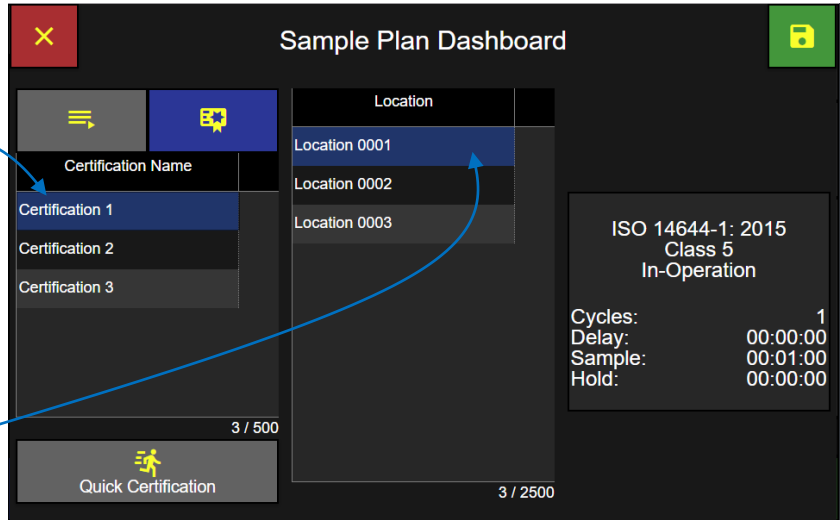

Press the green Save button to load the selected certification name and current selected location and return to the Home screen ready to start the certification sample.



Certification Loaded on Home Screen

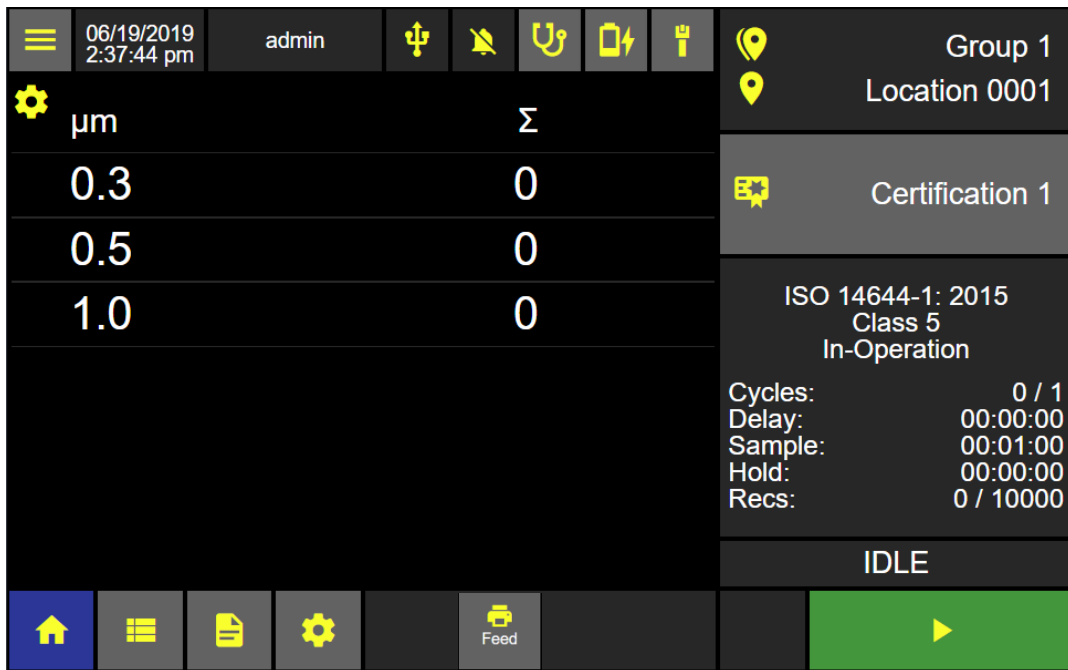

Quick Certification

Quick Certification is a single input screen for selecting all the required sample parameters for a certification report.

Press the Quick Certification button to display the Quick Cert input screen.

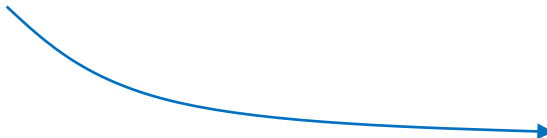

Sample Plan Dashboard

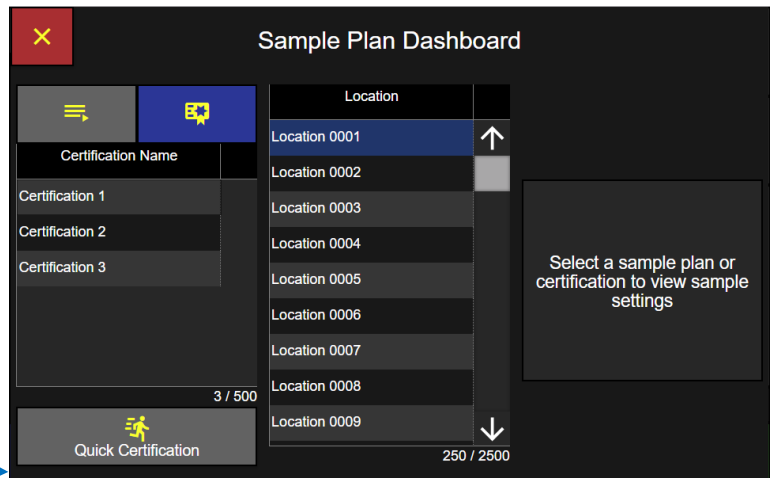

Quick Certification Edit Screen

Press any input button to edit.

Press the green Save button to Save the Quick Certification and return to the Sample Plan Dashboard.

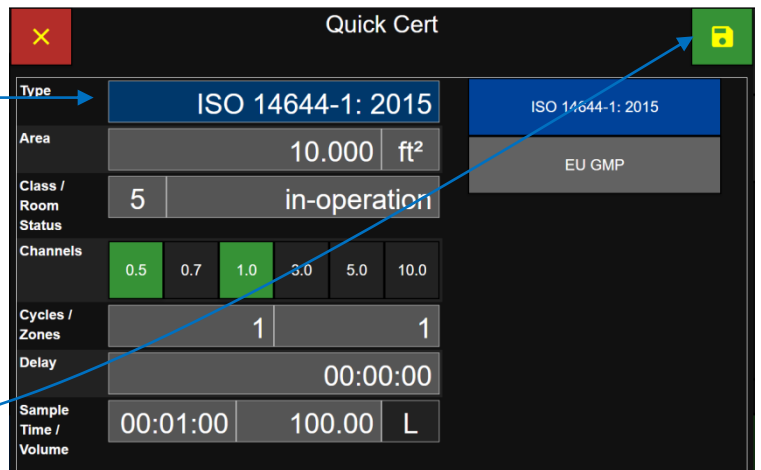
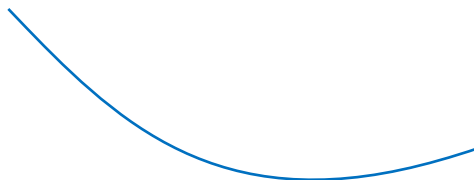

Sample Plan Dashboard

Press the green Save button to Save the Quick Certification to the Home screen.

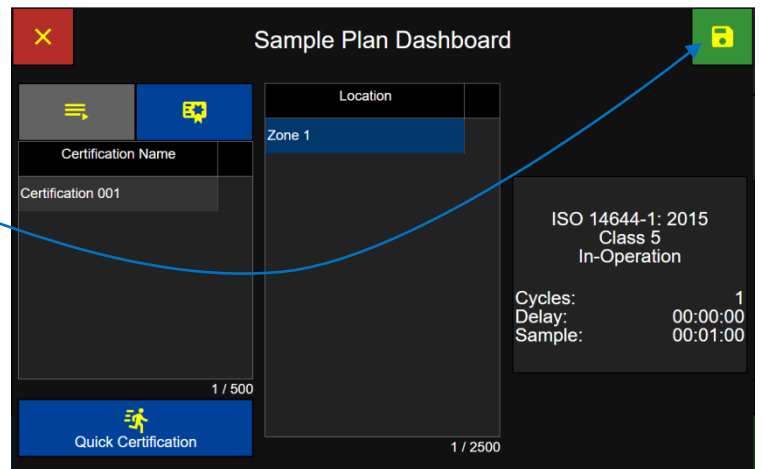
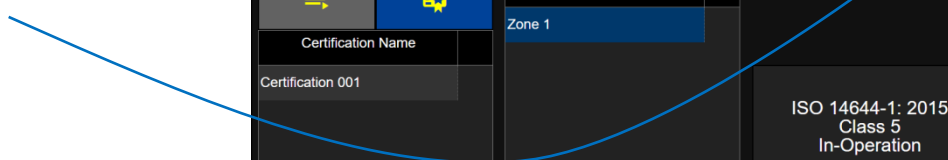

View Options

While sampling, particle count data may be viewed through multiple view options: Data Table View, Histogram View, Sample Grid View, Histogram View, Graph View and Environmental View. From the Home screen press the View Options button to display the View Options Menu.

Home Screen: View Options Bar Displayed

Select View Option

- Data Table View
- Sample Grid View
- Histogram View
- Graph View
- Environmental View

Press a view option button and the home screen will change to that view option and settings.

µm	Σ
0.3	0
0.5	0
1.0	0
3.0	0
5.0	0
10.0	0

Data Table View

Press the view options gear icon to display the data table view settings.

The data table view settings can provide up to three columns of data that can be displayed while sampling.

µm	Σ
0.3	480
0.5	420
1.0	360
3.0	300
5.0	240
10.0	180

Data Table View Settings

Enable Column

Select Enable to display that column in the data table view. Select Disable not to display that column.

Display Counts, Warning or Alarm

Select Count to display the particle count, or Select Warning to display particle counts exceeding the warning threshold level, or select Alarm to display particle counts exceeding the alarm threshold level.

Cumulative or Differential

Select Cumulative or Differential to display either cumulative or differential data counts.

Raw or Normalize Units

Select Raw or Norm to display data counts either Raw or Normalized
 Select units of volume for normalized particle counts.

Save Data Table View Settings

Press the return icon to save the data table view settings.



Data Table View Settings

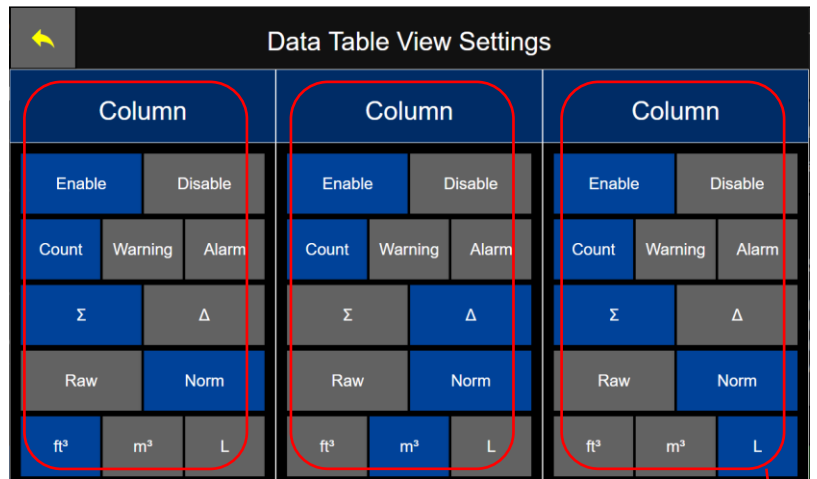

Home Screen, Data Table View 3 columns enabled

The ApexZ Home screen Data View Option will display the data specified in 3 columns.

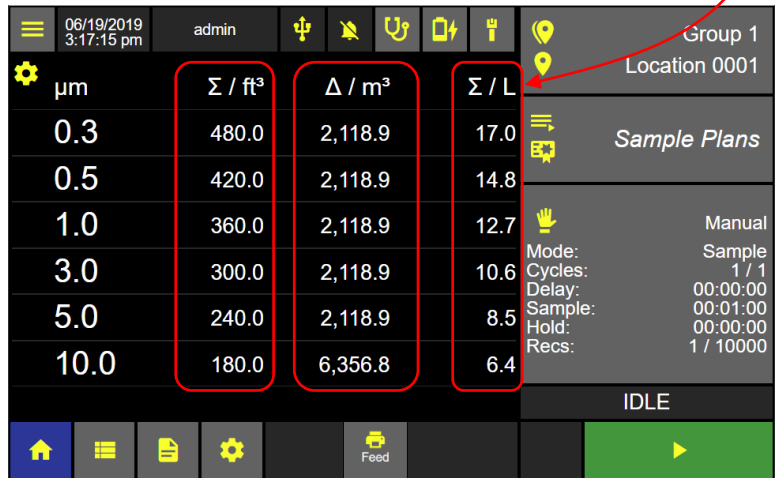

Sample Grid View

Select the Sample Grid View options icon from the view options drop down list.

Sample Grid View displays locations assigned to a Sample Plan or a certification with a colored background indicating the sampling status for that location.

There will be no gear icon displayed on the Sample Grid View screen.

Select View Options Sample Grid View

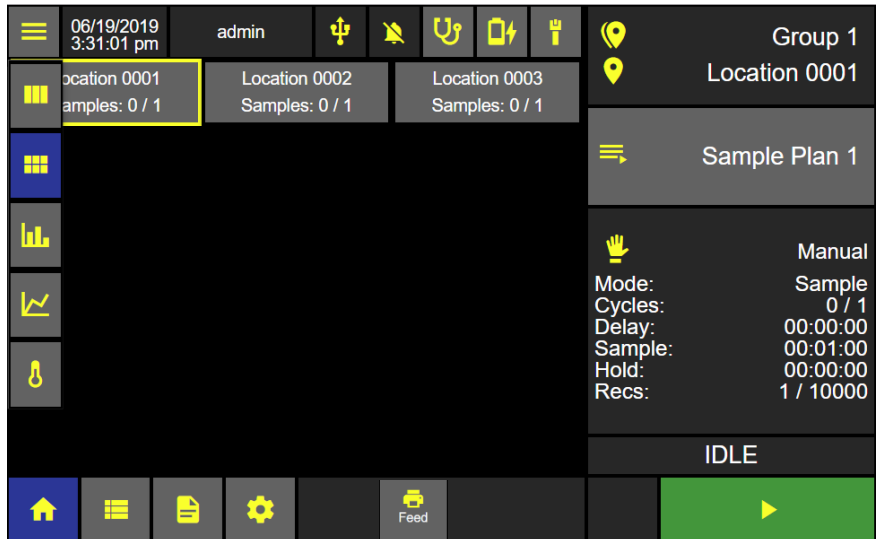

Sample Grid View Location Button

Each location button will display two lines of text:

Location name
Number of samples taken / total number of sample cycles

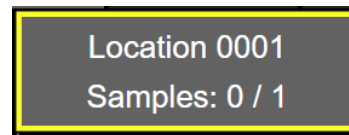

Sample Grid View Screen

Sample Grid View allows the user to easily select the current sampling location by pressing the matching location name button on the Sample Grid View screen.

When selected, the location button will highlight with a yellow border color indicating it is the current location to be sampled.

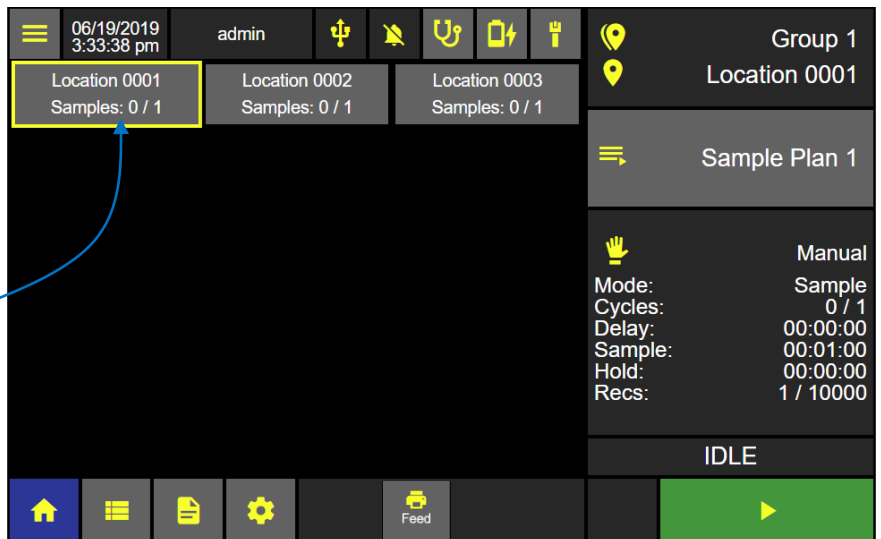

Home Screen – Sample Grid View

Identify your monitoring point location and select that location on the Sample Grid View screen by pressing that location name button. The selected location button will highlight with a yellow border and the Start button will highlight green indicating the ApexZ instrument is ready to sample at the current location. Make sure your sample tube and sample probe are in place at the selected location point.

Press the green start button to start sampling at the current selected location.

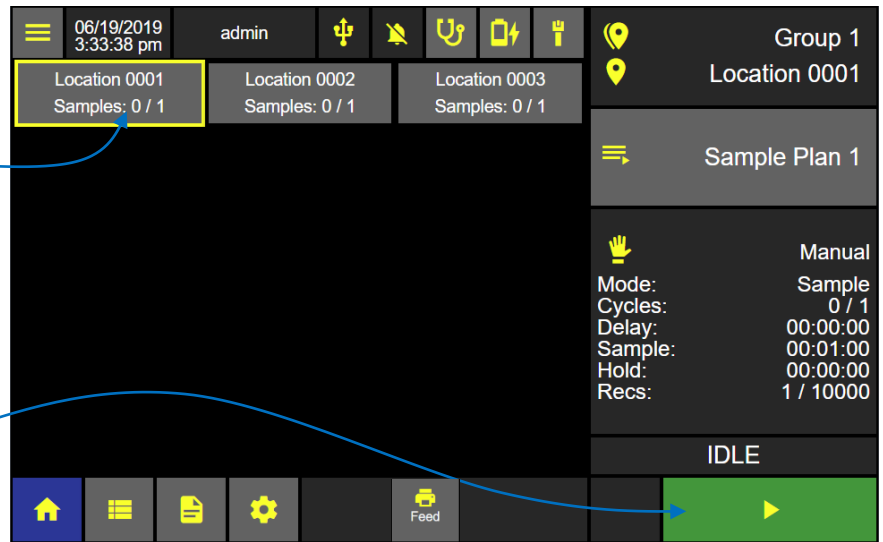

After sampling completes then move the ApexZ to the next monitoring point. Make sure your sample tube and probe are in place at the new location and then select the matching current location on the Sample Grid View screen. Press the green start button to start sampling at the new location.

Location Color Status

Home Screen – Sample Grid View

Yellow border = current location

Green back ground = sample completed with no warning or alarms exceeded.

Blue back ground = currently sampling.

Note if a sample has multiple cycles then the back ground color will change after the first cycle is completed if the particle count exceeds the warning or alarm thresholds or the sensor goes into fault.

Grey back ground = location not sampled

Orange back ground = sample completed at that location and the warning threshold particle count was exceeded.

Red back ground = sample completed and the alarm threshold particle count was exceeded at that location. Note a red back ground color will also display if the instrument was in fault for its laser, flow or calibration due date.

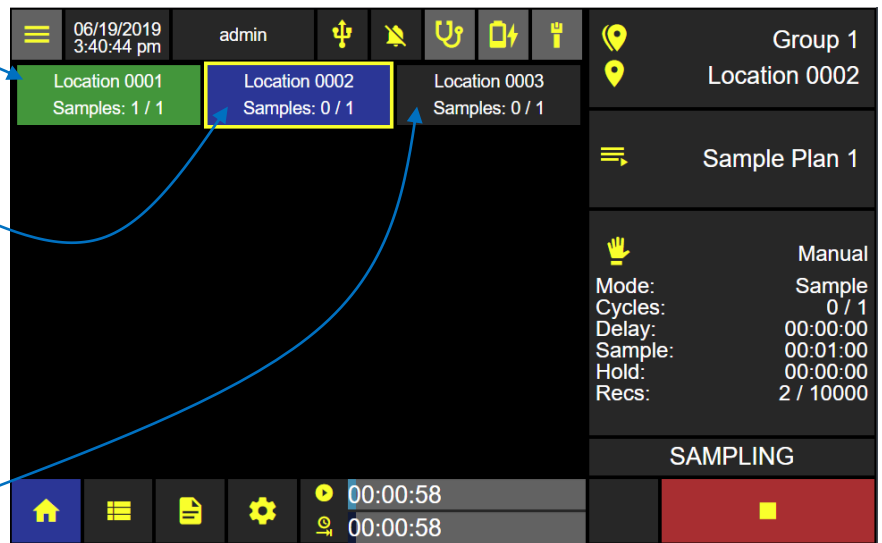

Sample Grid View Sample Data Display

To view data counts while sampling from Sample Grid View, press the location button that is currently sampling and highlighted blue.

Data counts (from the first two columns of the Data View Settings) will display in a pop up window with white text against a blue background.

Home Screen – Sample Grid View

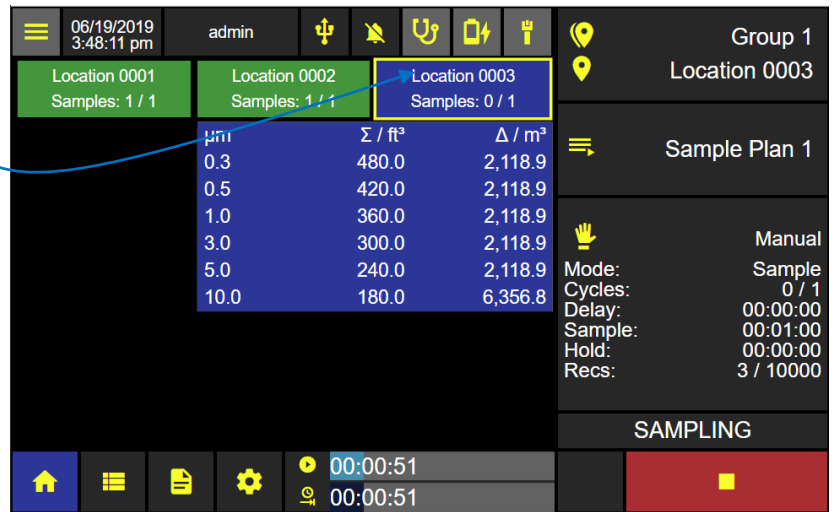

When a Sample Plan is running the user will be prompted to start each sample at each location. The user may select any of the available locations from that Sample Plan to be the next location. When the desired next location has been selected and the sample probe is at the matching location, the user may press Start to begin sampling at that location.

Histogram View

From the Home Screen press the View Options button then press the Histogram View button.



Select Histogram View Option

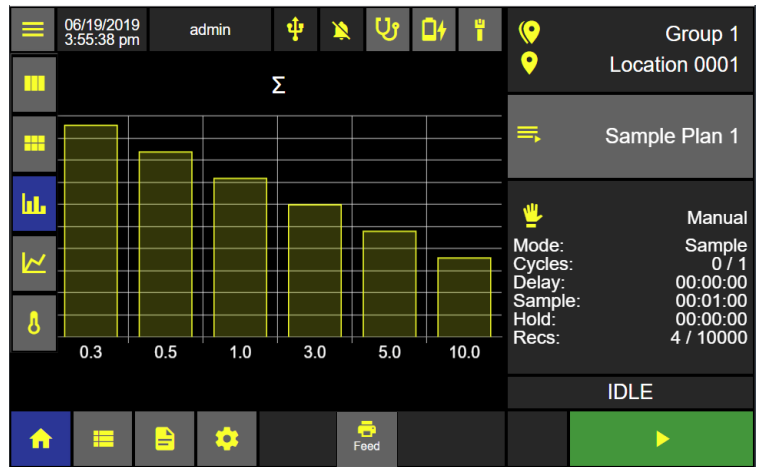

Press the gear icon to display the Histogram View Settings.

Histogram View Screen

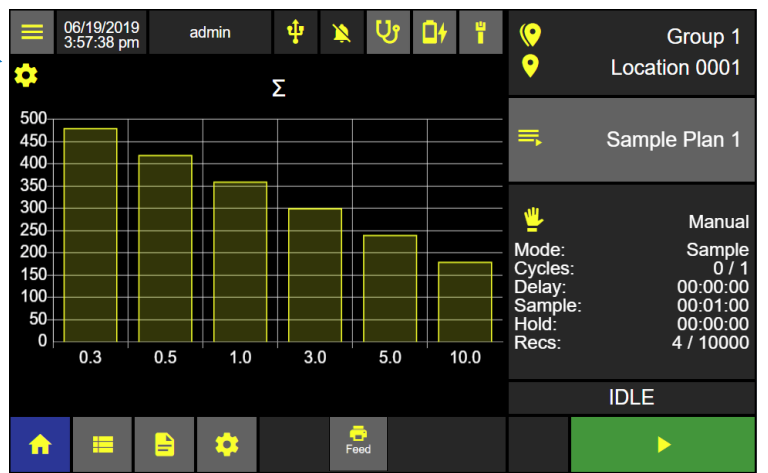

Histogram View Settings

Select Linear or Logarithmic.
 Select Cumulative (Σ) or the Differential (Δ).
 Select Raw or Normalized with units of volume.

If Normalized is selected then select units; cubic feet, cubic meters or liters.



Press the back arrow button to apply the settings and return to the Histogram View.

Histogram View Settings

Linear	Logarithmic	
Σ	Δ	
Raw	Norm	
ft ³	m ³	L

Note: Histogram View displays real time particle count data as a Histogram.

Selecting Graph View Option

Graph View

Press the View Options button.
Then press the Graph View button.



Graph View displays sampled data points continuously in real time on a line graph. A new line graph will begin when sampling is stopped and restarted.

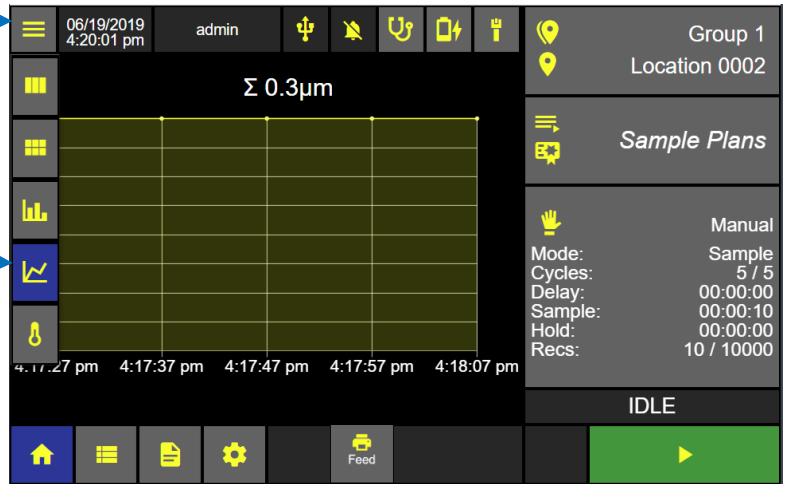

Graph View Screen

Press the Graph View gear button to display the Graph Settings.

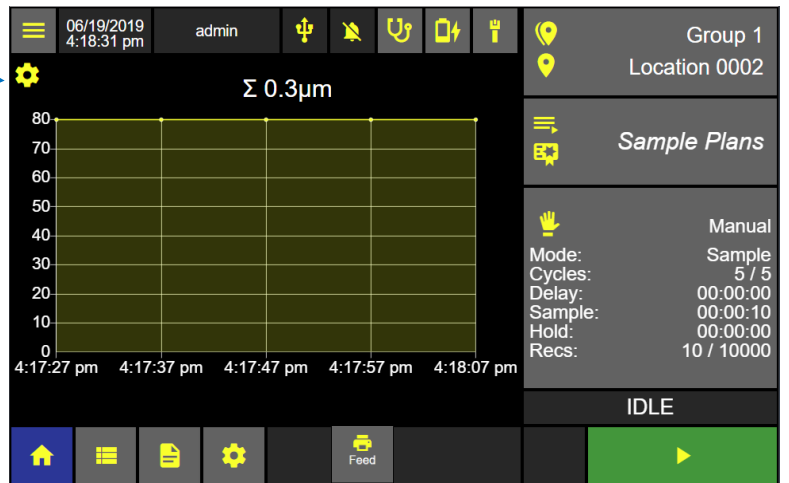

Graph Settings

Graph View Settings

Select Linear or Logarithmic
Select Channel size
Select Format Raw or Normalized with units ft³, m³, L.



Press the back button to return to the Graph View screen.

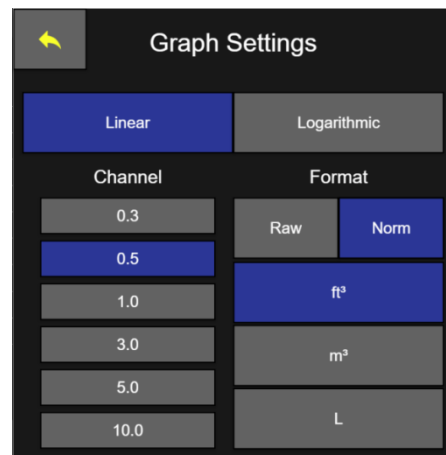

Environmental View

ApexZ can sample and collect temperature and humidity data readings while counting particles during a sample session.

Connect an ApexZ Temperature / Humidity probe and view temperature and humidity data while sampling in real time from the Environmental View Option screen.

From the Home Screen press the View Options button. Then press the Environmental View button.



Select Environmental View Option

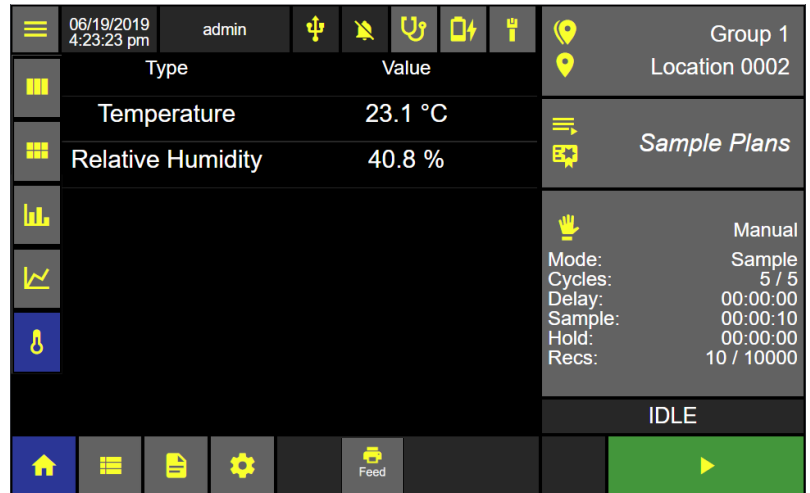

Environmental View Screen

Press the gear button to display the Environmental View Settings Screen

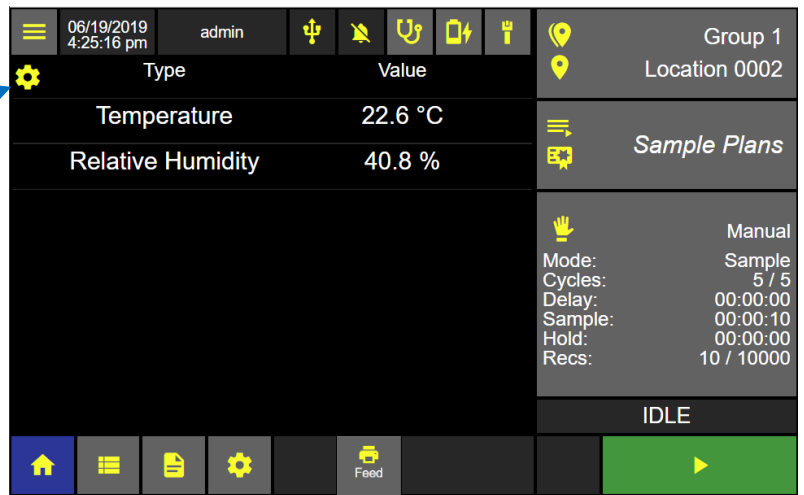

Environmental View Settings Screen

Environmental View Settings

Press the enable button and it will highlight blue indicating the sensor type has been enabled.

Press Units for °F or °C.

Relative Humidity will be displayed as %.



Press the Back button to return to the Home page Environmental View.

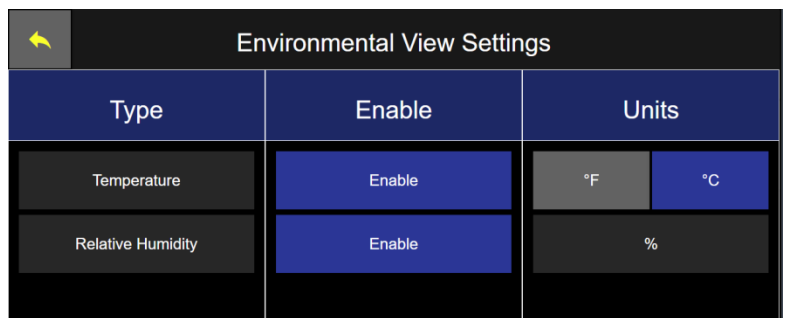

Sampling with Data Tags

See Instrument–Options–Data to create and enable data tag prompts pre-sample or post-sample.

Pre-Sample Data Tag Input (*created and enabled from the Instrument-Options-Data screen*) will display on the ApexZ screen immediately after pressing START.

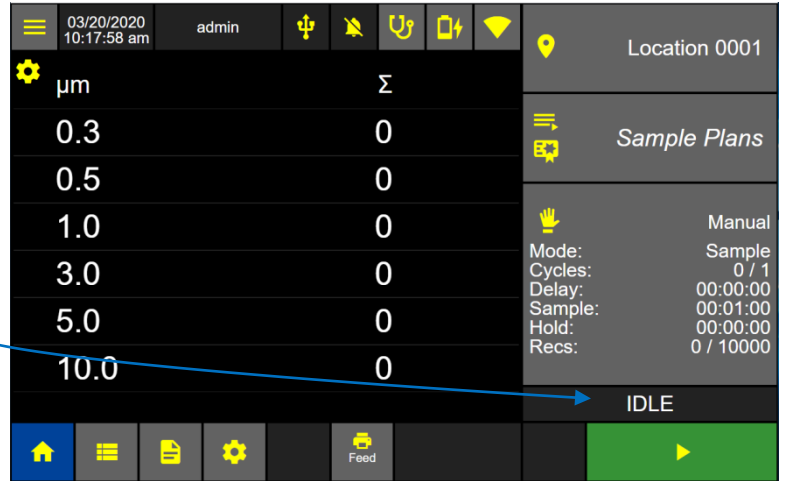

Select the data tag name to enter or scan.

Scan or touch to input the data tag.

If the user touches the input button (no scanner) then ApexZ will display the Enter Value input screen and the user can input the data tag value and press the green Apply button to apply the data tag value.

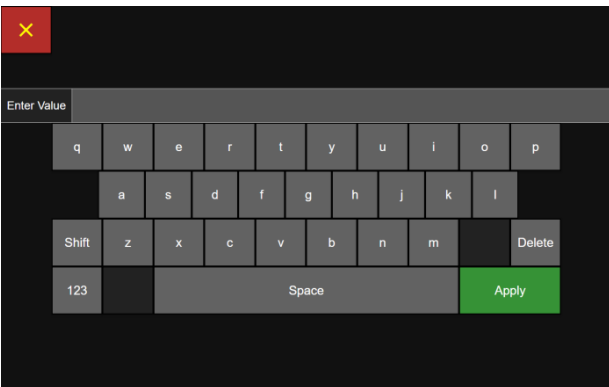
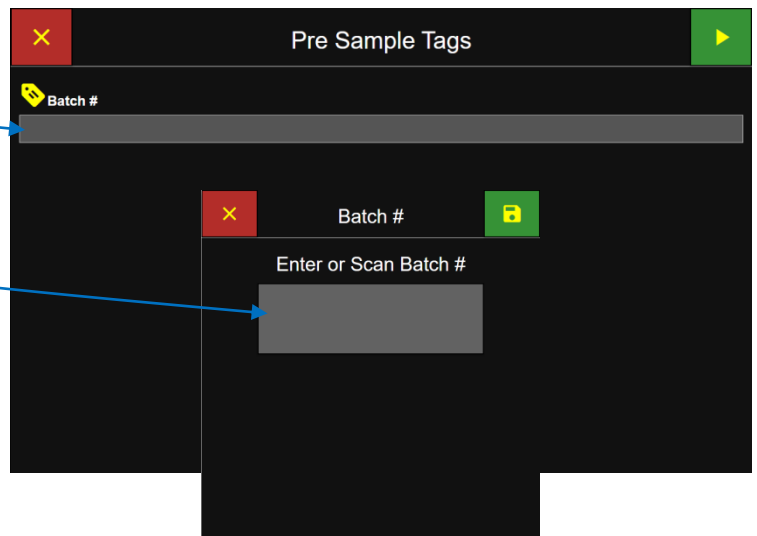

Post-Sample Data Tag Input (created and enabled from the *Instrument-Options-Data* screen) will display on the ApexZ screen immediately after sampling is completed.

Scan or touch to input the data tag.

If the user touches the input button (no scanner) then ApexZ will display the Enter Value input screen and the user can input the data tag value and press the green Apply button to apply the data tag value.

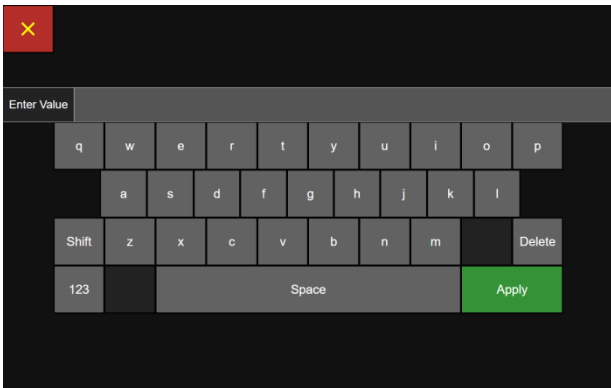
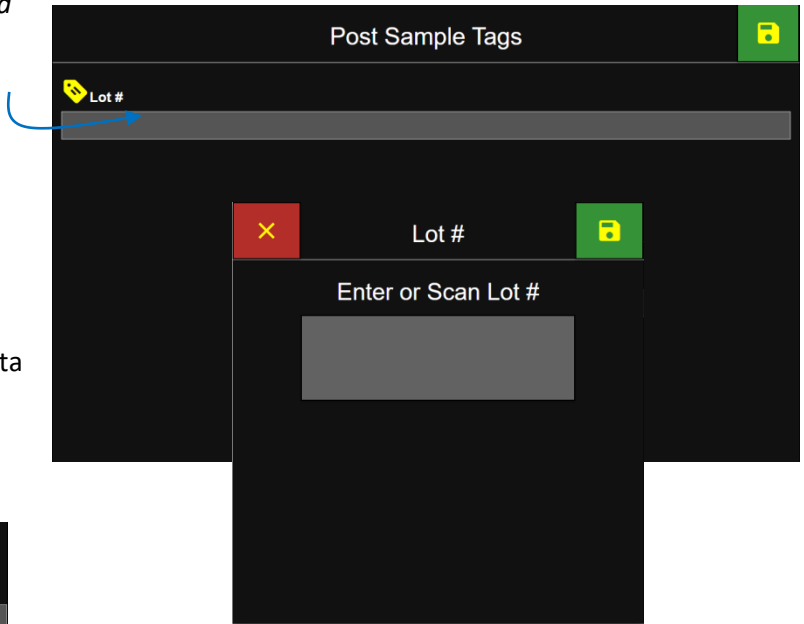

Blank Page

Data Screen

View Data Records

The ApexZ can store up to 10,000 sample data records and display them on the data screen. The user can scroll up and down, left and right and view all saved data records. Individual or multiple data records can be selected and a Data Tag can be entered and saved in the data record.

Data screen columns displayed

- Date and Time stamp
- Sample Name
- Group Name
- Location Name
- Particle Counts by Channel Size
- Analog Temp and RH
- Alerts for Alarm and Warning conditions
- Faults for Flow, Laser, and Service
- Username
- Data Tag(s)

Data Screen

Timestamp	Sample	Group	Location	Channel	Filter
	Name				
06/21/2019, 9:39:06 am	Sample Plan 1	Group 1	Fill 1	↑	Time
06/21/2019, 9:38:56 am	Sample Plan 1	Group 1	Fill 1		Group
06/21/2019, 9:38:46 am	Sample Plan 1	Group 1	Fill 1		Location
06/21/2019, 9:38:36 am	Sample Plan 1	Group 1	Fill 1		Sample Plan
06/21/2019, 9:38:26 am	Sample Plan 1	Group 1	Fill 1		Tag
06/21/2019, 9:38:05 am	Sample Plan 1	Group 1	Fill 1		Alert / Fault
06/21/2019, 9:37:55 am	Sample Plan 1	Group 1	Fill 1	↓	
06/21/2019, 9:37:45 am	Sample Plan 1	Group 1	Fill 1		

viewing: 35 / 35 selected: 0 data buffer: 35 / 10000

Note: Hidden columns can be viewed by clicking on the column expansion arrow buttons to the right of each column heading.

Channels column expanded

Press the right arrow button to expand and the left arrow button to collapse the channel columns.

Slide the horizontal scroll bar or press the right and left arrows to view additional data columns.

Slide the vertical scroll bar or click on the arrows up and down to scroll through data records saved on the ApexZ.

Data screen displaying channel columns expanded

Timestamp	Channels					Filter
	0.3	0.5	1.0	3.0	5.0	
06/21/2019, 9:39:06 am	n/a	70	n/a	n/a	↑	Time
06/21/2019, 9:38:56 am	n/a	70	n/a	n/a		Group
06/21/2019, 9:38:46 am	n/a	70	n/a	n/a		Location
06/21/2019, 9:38:36 am	n/a	70	n/a	n/a		Sample Plan
06/21/2019, 9:38:26 am	n/a	70	n/a	n/a		Tag
06/21/2019, 9:38:05 am	n/a	70	n/a	n/a		Alert / Fault
06/21/2019, 9:37:55 am	n/a	70	n/a	n/a	↓	
06/21/2019, 9:37:45 am	n/a	70	n/a	n/a		

viewing: 35 / 35 selected: 0 data buffer: 35 / 10000

Analog, Alerts, Faults, User and Data Tag

Press the right arrow button to expand and the left arrow button to collapse the data columns.

Analog Data Columns

Analog Data Columns	
TEMP	RH
22.63 °C	40.76 %
23.11 °C	41.95 %
23.11 °C	40.76 %
22.63 °C	41.95 %
23.11 °C	40.76 %
22.63 °C	41.95 %
23.11 °C	41.95 %

Alerts and Faults Columns

Alerts		Faults		
Alarm	Warning	Flow	Laser	Service
None	None	None	None	None
None	None	None	None	None
None	None	None	None	None
None	None	None	None	None
None	None	None	None	None
None	None	None	None	None
None	None	None	None	None

User and Data Tag Columns

User	Batch Tag	Lot Tag
admin	B1001	L0ABQ1
admin	B1001	L0ABQ1
admin	B1001	L0ABQ1
admin	B1002	L0ABQ2
admin	B1002	L0ABQ2
admin	B1002	L0ABQ2
admin	B1002	L0ABQ2

Use the horizontal scroll bar to view additional data columns to the right or swipe your finger on screen to scroll up or across and display additional rows and columns.

Note: Swipe the screen or slide the Elevator Bars to view additional columns to the right or left.

Status Bar

Data Screen

Viewing: #/#

Filtered data records / total data records.

Selected: #

This represents total data records currently selected / highlighted blue.

Data buffer: #/10,000

This represents total # of saved data records / total capacity (10,000 records).

Timestamp	Sample Name	Group	Location	Channels	Filter
06/21/2019, 9:39:06 am	Sample Plan 1	Group 1	Fill 1	0	Time
06/21/2019, 9:38:56 am	Sample Plan 1	Group 1	Fill 1		Group
06/21/2019, 9:38:46 am	Sample Plan 1	Group 1	Fill 1		Location
06/21/2019, 9:38:36 am	Sample Plan 1	Group 1	Fill 1		Sample Plan
06/21/2019, 9:38:26 am	Sample Plan 1	Group 1	Fill 1		Tag
06/21/2019, 9:38:05 am	Sample Plan 1	Group 1	Fill 1		Alert / Fault
06/21/2019, 9:37:55 am	Sample Plan 1	Group 1	Fill 1		
06/21/2019, 9:37:45 am	Sample Plan 1	Group 1	Fill 1		

viewing: 35 / 35

selected: 0

data buffer: 35 / 10000

Select Data Records

Press anywhere on a data record row and that data record will highlight blue indicating it is currently selected. Select additional rows and they will highlight blue indicating they are also selected now as a group.

Data records selected

Timestamp	Sample Name	Group	Location	Channels	Filter
06/21/2019, 9:39:06 am	Sample Plan 1	Group 1	Fill 1	0	Time
06/21/2019, 9:38:56 am	Sample Plan 1	Group 1	Fill 1		Group
06/21/2019, 9:38:46 am	Sample Plan 1	Group 1	Fill 1		Location
06/21/2019, 9:38:36 am	Sample Plan 1	Group 1	Fill 1		Sample Plan
06/21/2019, 9:38:26 am	Sample Plan 1	Group 1	Fill 1		Tag
06/21/2019, 9:38:05 am	Sample Plan 1	Group 1	Fill 1		Alert / Fault
06/21/2019, 9:37:55 am	Sample Plan 1	Group 1	Fill 1		
06/21/2019, 9:37:45 am	Sample Plan 1	Group 1	Fill 1		

viewing: 35 / 35

selected: 4

data buffer: 35 / 10000

Data Tags

Data Tags can be used to add process references to your sample data record. For example data tags “Batch #” and “Lot #” can be created and prompted for either Pre-Sample or Post-Sample. Data Tags can be entered by a standard USB barcode reader or input from the ApexZ touch screen keyboard. Data Tag input will be saved with the data record and displayed in columns on the ApexZ Data Screen.

Data Screen

Select Data Records

Select a single data record or a group of data records and they will highlight blue indicating these records are currently selected.

Press the Tag button to display the new data tag name screen.



Timestamp	Sample	Group	Location	Channels	Filter
	Name				
06/21/2019, 9:39:06 am	Sample Plan 1	Group 1	Fill 1	0:	Time
06/21/2019, 9:38:56 am	Sample Plan 1	Group 1	Fill 1		Group
06/21/2019, 9:38:46 am	Sample Plan 1	Group 1	Fill 1		Location
06/21/2019, 9:38:36 am	Sample Plan 1	Group 1	Fill 1		Sample Plan
06/21/2019, 9:38:26 am	Sample Plan 1	Group 1	Fill 1		Tag
06/21/2019, 9:38:05 am	Sample Plan 1	Group 1	Fill 1		Alert / Fault
06/21/2019, 9:37:55 am	Sample Plan 1	Group 1	Fill 1		
06/21/2019, 9:37:45 am	Sample Plan 1	Group 1	Fill 1		

Viewing: 35 / 35 selected: 4 data buffer: 35 / 10000

Input Data Tags to Data Records

Select the data tag to input.

Scan or touch to input the data tag.

If the user touches the input button (no scanner) then ApexZ will display the Enter Value input screen and the user can input the data tag value and press the green Apply button to apply the data tag value.

Data Tags

Batch # Press here to update

Lot # Press here to update

Batch # Press here to update

Enter or Scan Batch #

Enter Value

q	w	e	r	t	y	u	i	o	p	
a	s	d	f	g	h	j	k	l		
Shift	z	x	c	v	b	n	m	Delete		
123	Space							Apply		

Export Data Records

Data records on the ApexZ can be output to the printer, a USB key or a CIFS (Common Internet File System). Data exported to a USB and CIFS will be saved as a .csv, .lsdx, or .pdf file.

Data Screen

Select Data Records

Select a single data record or a group of data records.

To export All Data Records just press the export button without selecting any record(s).

Timestamp	Sample Name	Group	Location	Channels
06/21/2019, 9:39:06 am	Sample Plan 1	Group 1	Fill 1	0.1
06/21/2019, 9:38:56 am	Sample Plan 1	Group 1	Fill 1	0.1
06/21/2019, 9:38:46 am	Sample Plan 1	Group 1	Fill 1	0.1
06/21/2019, 9:38:36 am	Sample Plan 1	Group 1	Fill 1	0.1
06/21/2019, 9:38:26 am	Sample Plan 1	Group 1	Fill 1	0.1
06/21/2019, 9:38:05 am	Sample Plan 1	Group 1	Fill 1	0.1
06/21/2019, 9:37:55 am	Sample Plan 1	Group 1	Fill 1	0.1
06/21/2019, 9:37:45 am	Sample Plan 1	Group 1	Fill 1	0.1

Press the Export button to display the Export Screen.



Export Type Screen

Select Export Type

Select the Export Type: Printer, USB or CIFS buttons.

The selected output type button will highlight green.

Press the save button to start the Export.

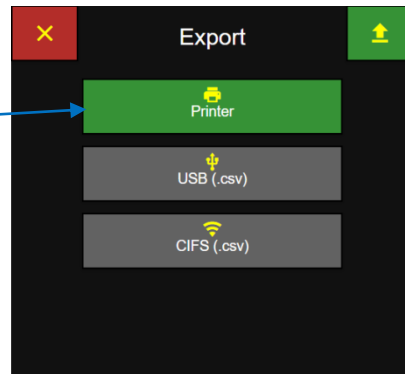

Note: 100 records is the maximum export to the Printer at a time.

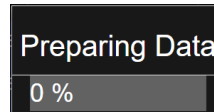

Note: If the USB button is grey or disabled, this indicates there is no USB key inserted. Insert a USB key into the ApexZ USB port to export.

Make Report from Data Records

Reports may be created from selecting a continuous set of data records from the Data Screen and then pressing the + Report button. Up to 120 continuous data records may be selected at one time to produce a Data Report. If over 120 data records are selected then the + Report button will become disabled.

After the + Report has been pressed, the user will be asked to set report sample parameters and create a new Report based on the selected data record samples collected. Follow these steps to select the data records, report type, channels; enter a new report name and save the report.

Data Screen

Select Data Records for Report

Press and highlight the desired data records to make a Report.

Timestamp	Sample Name	Group	Location	Channels	Filter
06/21/2019, 9:39:06 am	Sample Plan 1	Group 1	Fill 1	0.0	Time
06/21/2019, 9:38:56 am	Sample Plan 1	Group 1	Fill 1		Group
06/21/2019, 9:38:46 am	Sample Plan 1	Group 1	Fill 1		Location
06/21/2019, 9:38:36 am	Sample Plan 1	Group 1	Fill 1		Sample Plan
06/21/2019, 9:38:26 am	Sample Plan 1	Group 1	Fill 1		Tag
06/21/2019, 9:38:05 am	Sample Plan 1	Group 1	Fill 1		Alert / Fault
06/21/2019, 9:37:55 am	Sample Plan 1	Group 1	Fill 1		
06/21/2019, 9:37:45 am	Sample Plan 1	Group 1	Fill 1		

selected: 4 data buffer: 35 / 10000

Press the + Report button to display the New Report screen.

Note: Selecting data records from a filtered display of data records will not filter the data set included in the generated report. All data records from the oldest to the newest data record set selected will be included in the generated report.

Report Type



Press the Type button.

Select the Report Type:

- ISO 14644-1: 2015
- EU GMP
- ISO 14644-1: 1999
- FED 209E (Federal Standard 209E)

Press the Channel button next to display the Report Channels Screen.

New Report Type

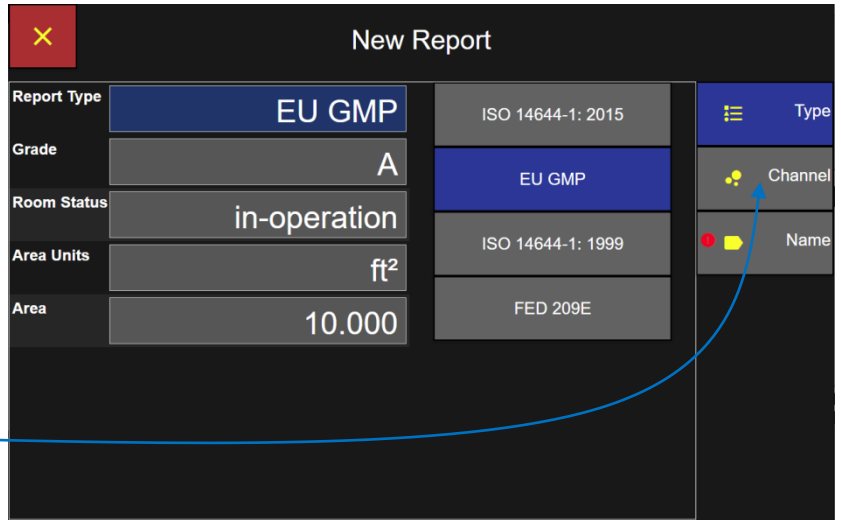

Report Channels

ApexZ will enable the required channels and will set the target limits for the chosen report type standard.

Enabled channels will display with a green check box.

Disabled channels will be displayed with the null symbol, a circle with a line through it. These particle channel sizes are not within the certification standard and may not be enabled.

Press the Name button to display the Report Name Screen.

New Report Channels

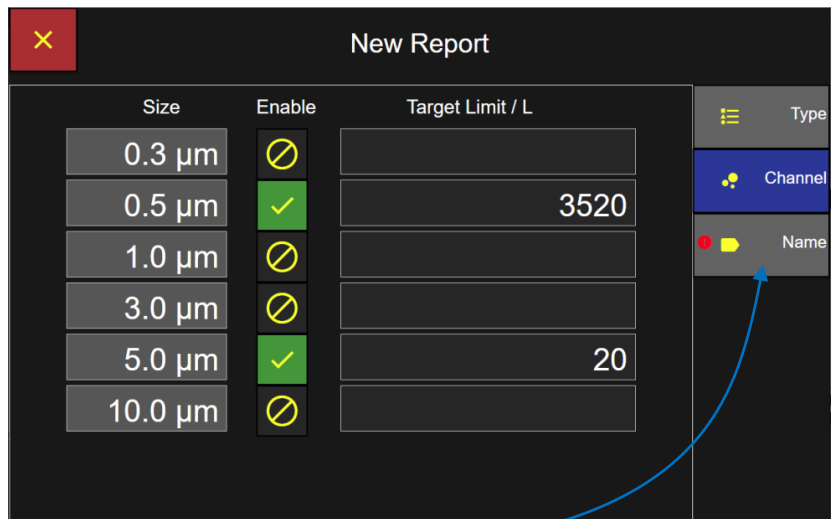

Report Name

Enter the Report Name from the keyboard.
Press the green Apply button to apply report name.
Press the green Save button to save the report and return to the Data Screen.



The new report name will be saved on the Report screen.

Report Name Screen

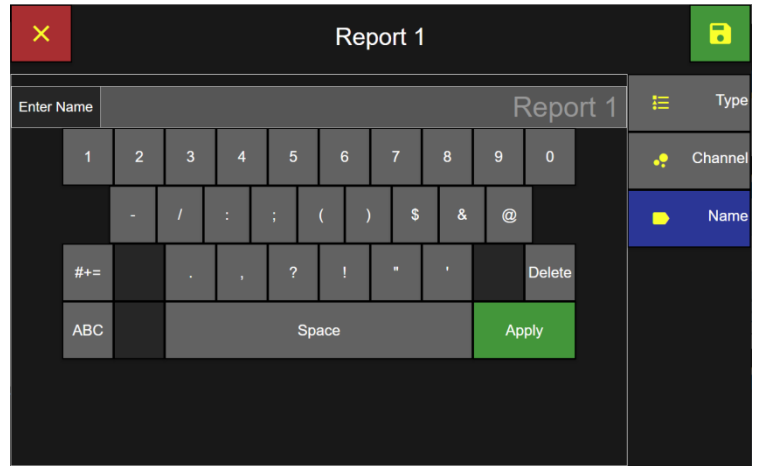

Filter Data Records

Data Screen

From the Data Screen:

Press the Time button to display the Date & Time Screen Filter



Timestamp	Sample Name	Group	Location	Channels	Filter
06/21/2019, 9:39:06 am	Sample Plan 1	Group 1	Fill 1	0.0	Time
06/21/2019, 9:38:56 am	Sample Plan 1	Group 1	Fill 1		Group
06/21/2019, 9:38:46 am	Sample Plan 1	Group 1	Fill 1		Location
06/21/2019, 9:38:36 am	Sample Plan 1	Group 1	Fill 1		Sample Plan
06/21/2019, 9:38:26 am	Sample Plan 1	Group 1	Fill 1		Tag
06/21/2019, 9:38:05 am	Sample Plan 1	Group 1	Fill 1		Alert / Fault
06/21/2019, 9:37:56 am	Sample Plan 1	Group 1	Fill 1		
06/21/2019, 9:37:45 am	Sample Plan 1	Group 1	Fill 1		
06/21/2019, 9:37:35 am	Sample Plan 1	Group 1	Fill 1		

Viewing: 35 / 35 selected: 0 data buffer: 35 / 10000

Filter Start date and time

Press the Start Date button and select the starting day, month and year for the filter period using the keypad.

Press the **Start Time** button and enter the start time on the keypad.

Filter Data – Date Keypad

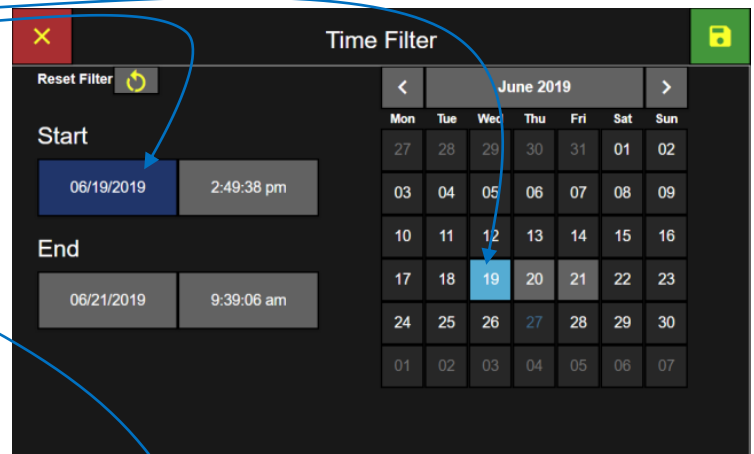

Filter End date and time

Press the End Date button and enter the end date on the keypad.

Press the End Time button and enter the end time on the keypad.

Press the green Apply button and press the green Save button to apply the Date and Time filter to the data records on the Data Screen.

Filter Data – Time Keypad

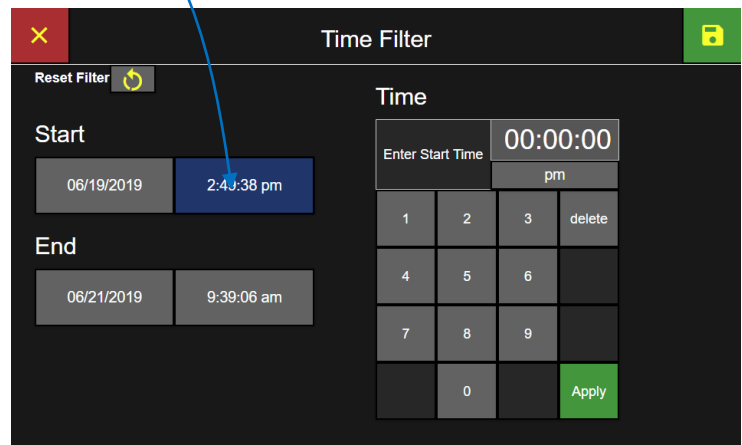

Filter Groups

Press the Group button to display the Filter Group Screen.



Data Screen

Timestamp	Sample ▾	Group	Location	Channels ▾	Filter
	Name				0:
06/21/2019, 9:39:06 am	Sample Plan 1	Group 1	Fill 1	↑	Time
06/21/2019, 9:38:56 am	Sample Plan 1	Group 1	Fill 1		Group
06/21/2019, 9:38:46 am	Sample Plan 1	Group 1	Fill 1		Location
06/21/2019, 9:38:36 am	Sample Plan 1	Group 1	Fill 1		Sample Plan
06/21/2019, 9:38:26 am	Sample Plan 1	Group 1	Fill 1		Tag
06/21/2019, 9:38:05 am	Sample Plan 1	Group 1	Fill 1		Alert / Fault
06/21/2019, 9:37:55 am	Sample Plan 1	Group 1	Fill 1		
06/21/2019, 9:37:45 am	Sample Plan 1	Group 1	Fill 1		

viewing: 35 / 35 selected: 0 data buffer: 35 / 10000

Select Group to Filter

Select the Group name(s) to be included in the data records filter and press the adjacent include button. The button will highlight green with a check mark indicating the group name has been included in the filter.

Press the include button a second time to remove selection. A grey background color indicates no filter on this parameter.

Press the green Save button to save the filter settings and return to the Data Screen.

Group Filter

✕
Group Filter
Save

Reset Filter ↻

Include	Group Name
<input type="checkbox"/>	All locations
<input checked="" type="checkbox"/>	Group 001
<input type="checkbox"/>	Group 002
<input type="checkbox"/>	Group 003



Filter Locations

Press the Location button to display the Filter Location Screen.

Data Screen

The screenshot shows a data table with columns: Timestamp, Sample Name, Group, Location, and Channels. The data rows show timestamps from 06/21/2019, 9:39:06 am to 9:37:35 am, all with 'Sample Plan 1', 'Group 1', and 'Fill 1'. A 'Filter' sidebar on the right has options for Time, Group, Location, Sample Plan, Tag, and Alert / Fault. The 'Location' filter option is highlighted with a blue arrow. At the bottom, there are navigation icons and status information: 'selected: 0' and 'data buffer: 35 / 10000'.

Location Filter

Select the Include button next to the Location name(s) to be included in the data records filter.

The button will highlight green with a check mark indicating it will be included in the data record filter.

Press the green Save button to save the Location filter and return to the Data Screen.

The screenshot shows the 'Location Filter' screen with a 'Reset Filter' button and a list of locations. The 'Include' column has checkboxes for 'Fill 1', 'Fill 2', 'Fill 4', 'Fill 7', 'Location 0001', 'Location 0002', and 'Location 0003'. The checkboxes for 'Fill 1' and 'Fill 2' are checked and highlighted green. A green 'Save' button is in the top right corner.



Data Screen

Filter Sample Plans and Certifications

Press the Sample Plan button to display the Filter Sample Plans screen.

Timestamp	Sample Name	Group	Location	Channels	Filter
06/21/2019, 9:39:06 am	Sample Plan 1	Group 1	Fill 1	0.:	Time
06/21/2019, 9:38:56 am	Sample Plan 1	Group 1	Fill 1		Group
06/21/2019, 9:38:46 am	Sample Plan 1	Group 1	Fill 1		Location
06/21/2019, 9:38:36 am	Sample Plan 1	Group 1	Fill 1		Sample Plan
06/21/2019, 9:38:26 am	Sample Plan 1	Group 1	Fill 1		Tag
06/21/2019, 9:38:05 am	Sample Plan 1	Group 1	Fill 1		Alert / Fault
06/21/2019, 9:37:55 am	Sample Plan 1	Group 1	Fill 1		
06/21/2019, 9:37:45 am	Sample Plan 1	Group 1	Fill 1		

Filter Sample Plans and Certifications

Press the Include button next to the Sample Plan or Certifications to be included in the data records filter.

Sample Plan Filter

Reset Filter ↺ Reset Filter ↺

Include	Sample Plan Name	Include	Certification Name
<input type="checkbox"/>	Filling Line	<input checked="" type="checkbox"/>	Certification 1
<input checked="" type="checkbox"/>	Sample Plan 1	<input type="checkbox"/>	Certification 2
<input type="checkbox"/>	Sample Plan 2	<input type="checkbox"/>	Certification 3
<input type="checkbox"/>	Sample Plan 3		

The button will highlight green with a check mark indicating it will be included in the data record filter.

Press the green Save button to activate the filter settings and return to the Data Screen.



Filter Tags

Press the Tag button to display the Tag Filter screen.

Data Screen

Timestamp	Sample	Group	Location	Channels	Filter
	Name				
06/21/2019, 9:39:06 am	Sample Plan 1	Group 1	Fill 1	0.:	Time
06/21/2019, 9:38:56 am	Sample Plan 1	Group 1	Fill 1		Group
06/21/2019, 9:38:46 am	Sample Plan 1	Group 1	Fill 1		Location
06/21/2019, 9:38:36 am	Sample Plan 1	Group 1	Fill 1		Sample Plan
06/21/2019, 9:38:26 am	Sample Plan 1	Group 1	Fill 1		Tag
06/21/2019, 9:38:05 am	Sample Plan 1	Group 1	Fill 1		Alert / Fault
06/21/2019, 9:37:55 am	Sample Plan 1	Group 1	Fill 1		
06/21/2019, 9:37:45 am	Sample Plan 1	Group 1	Fill 1		

Tag Filter Screen

Select the Include button next to the Tag name(s) to be included in the data records filter.

The button will highlight green with a check mark indicating it will be included in the data record filter.

Press the green Save button to activate the filter settings and return to the Data Screen.

Include	Data Tag Name	Value
<input checked="" type="checkbox"/>	Batch	137900888
<input type="checkbox"/>	Batch	5678
<input type="checkbox"/>	Comment	OK
<input checked="" type="checkbox"/>	Comment	Alarm ack
<input type="checkbox"/>	Notes	
<input type="checkbox"/>	Sample ID	2577388
<input checked="" type="checkbox"/>	Sample ID	1234



Data Screen

Filter Alert/Fault

Press the Alert/Fault button to display the Alert/Fault Screen.

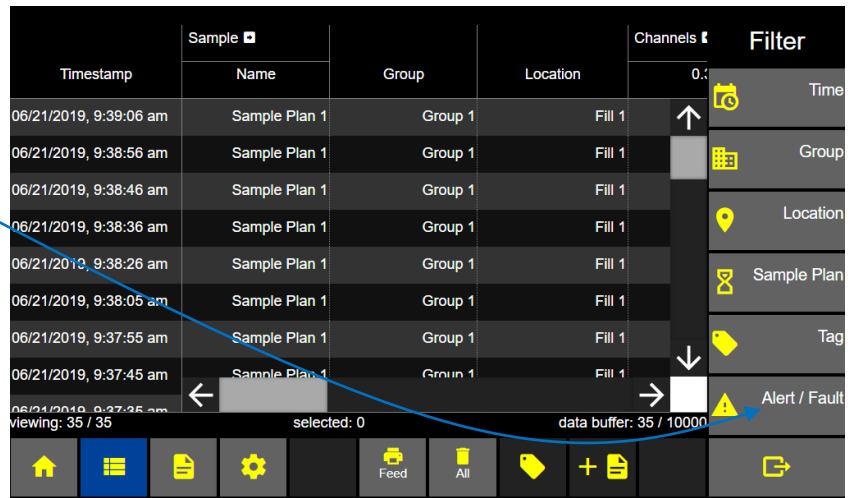

Filter Alert / Fault

Select the Include button next to the Alert/Fault(s) to be included in the data records filter.

The button will highlight green with a check mark indicating it will be included in the data record filter.

Press the green Save button to activate the filter settings and return to the Data Screen.

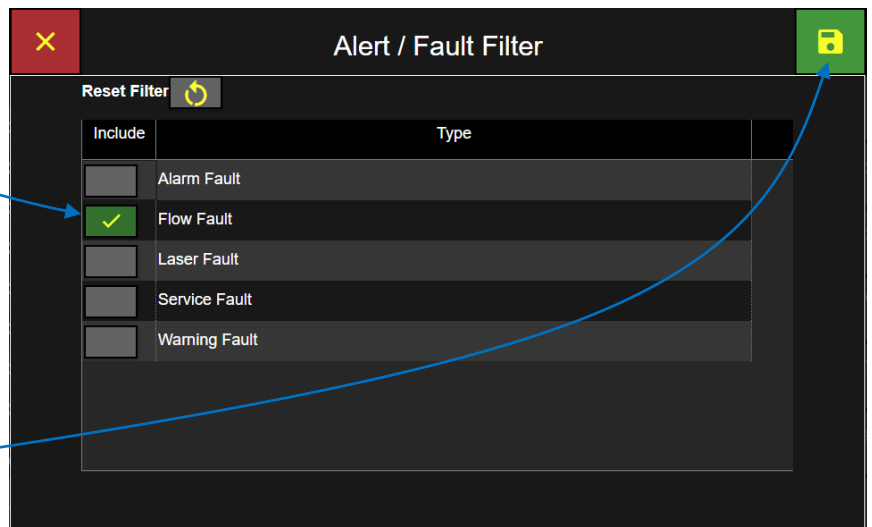

Note: Press the Reset Filter button to disable all included filters.

Delete all data records

ApexZ will store up to 10,000 sample data records and after the database is full then the newest data records will copy over the oldest data records wrapping the database.

Data records may not be deleted individually.

To delete All data records press the trash can button to display the Data Records Delete Screen.

Data Screen

Timestamp	Sample	Group	Location	Channels	Filter
	Name				
06/21/2019, 9:39:06 am	Sample Plan 1	Group 1	Fill 1	0.0	Time
06/21/2019, 9:38:56 am	Sample Plan 1	Group 1	Fill 1		Group
06/21/2019, 9:38:46 am	Sample Plan 1	Group 1	Fill 1		Location
06/21/2019, 9:38:36 am	Sample Plan 1	Group 1	Fill 1		Sample Plan
06/21/2019, 9:38:26 am	Sample Plan 1	Group 1	Fill 1		Tag
06/21/2019, 9:38:05 am	Sample Plan 1	Group 1	Fill 1		Alert / Fault
06/21/2019, 9:37:55 am	Sample Plan 1	Group 1	Fill 1		
06/21/2019, 9:37:45 am	Sample Plan 1	Group 1	Fill 1		
06/21/2019, 9:37:35 am	Sample Plan 1	Group 1	Fill 1		

Viewing: 35 / 35 selected: 0 data buffer: 35 / 10000

Buttons: Home, List, Document, Settings, Feed, All, Tag, Add, Refresh

Confirm Data Records Delete

Press green check mark button to delete ALL data records.

Or press the red x button to cancel and data records will NOT be deleted.

Delete?

Delete All Data Records?

Note: ApexZ can only delete all records. There is no option to delete individual records.

Reports

Report Screen

The Reports screen displays a list of all saved certification reports.

Reports that have Passed their certification conditions will be highlighted green and display “PASS” in the Results column. Reports that have failed their certification conditions will be highlighted red and display “FAIL”, indicating they have failed.

Reports Screen

From the Home Screen select the Report icon button to display the Report screen.



Created	Name	Result		Type	Filter	
		Pass / Fail				
06/28/2019, 1:07:55 pm	Cert 4	FAIL		ISO 14644-1: 2015		
06/28/2019, 1:00:06 pm	Cert 3	FAIL		ISO 14644-1: 2015		
06/27/2019, 2:24:20 pm	Cert 2	PASS		EU GMP		
06/27/2019, 2:17:49 pm	Cert 1	FAIL		ISO 14644-1: 2015		

Expand Result Columns

Press the arrow button to expand the Result columns.

Use the horizontal slider button or arrow buttons to display more columns to the right or left.

Result Columns Expanded

Created	Name	Result		Type	Filter	
		Overlimit Fault	Min Volume Fault			
06/28/2019, 1:07:55 pm	Cert 4	Fault	None	ISO 14644-1: 2015		
06/28/2019, 1:00:06 pm	Cert 3	Fault	None	ISO 14644-1: 2015		
06/27/2019, 2:24:20 pm	Cert 2	None	None	EU GMP		
06/27/2019, 2:17:49 pm	Cert 1	Fault	None	ISO 14644-1: 2015		

Report data columns displayed include date created, report name, and fault results for over limit data counts, minimum sample volume not met, minimum samples not taken, minimum sample time not sampled, and instrument fault.

Report Result Column Expanded

Over Limit, Minimum Volume, Minimum Locations, Minimum Samples, Min. Sample Time, Instrument Fault

Created	Result	Overlimit Fault	Min Volume Fault	Min Loc Fault	Min Samples Fault	Min Sample Time Fault	Instrument Fault
06/28/2019, 1:07:55 pm	Fault	Fault	None	None	None	None	None
06/28/2019, 1:00:06 pm	Fault	Fault	None	None	None	None	None
06/27/2019, 2:24:20 pm	None	None	None	None	None	None	None

Filter Report List

The list of reports displayed on the Reports screen can be filtered by the date the report was created, the report type or the report pass/fail status.

Filter report date and time

From the Reports Screen press the Created button to go to the Filter Created Screen

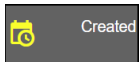

Reports Screen

Created	Name	Result	Type
		Pass / Fail	
05/07/2019, 1:38:27 pm	Report 3	PASS	EU GMP
05/07/2019, 1:32:58 pm	Report 2	PASS	ISO 14644-1: 2015
05/07/2019, 1:26:38 pm	Report 1	PASS	ISO 14644-1: 2015

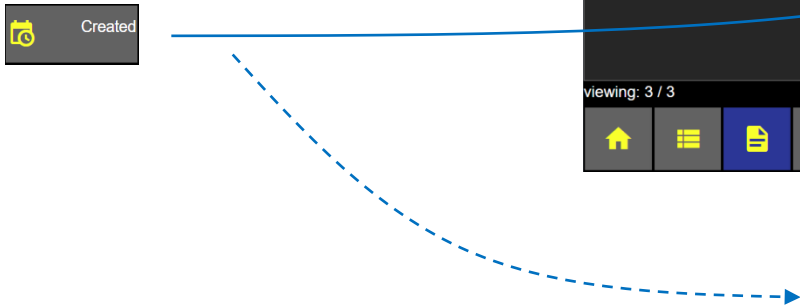

Select date, month and year.

Select the Start/End date button and the date keypad will be available to enter the start/end dates for the desired data records filter.

Created Filter

Reset Filter

<p>Start</p> <p>05/07/2019 1:26:38 pm</p> <p>End</p> <p>05/07/2019 1:38:27 pm</p>	<p style="text-align: center;">May 2019</p> <table border="1" style="width: 100%; text-align: center;"> <tr> <td>Mon</td><td>Tue</td><td>Wed</td><td>Thu</td><td>Fri</td><td>Sat</td><td>Sun</td> </tr> <tr> <td>29</td><td>30</td><td>01</td><td>02</td><td>03</td><td>04</td><td>05</td> </tr> <tr> <td>06</td><td style="background-color: #007bff; color: white;">07</td><td>08</td><td>09</td><td>10</td><td>11</td><td>12</td> </tr> <tr> <td>13</td><td>14</td><td>15</td><td>16</td><td>17</td><td>18</td><td>19</td> </tr> <tr> <td>20</td><td>21</td><td>22</td><td>23</td><td>24</td><td>25</td><td>26</td> </tr> <tr> <td>27</td><td>28</td><td>29</td><td>30</td><td>31</td><td>01</td><td>02</td> </tr> <tr> <td>03</td><td>04</td><td>05</td><td>06</td><td>07</td><td>08</td><td>09</td> </tr> </table>	Mon	Tue	Wed	Thu	Fri	Sat	Sun	29	30	01	02	03	04	05	06	07	08	09	10	11	12	13	14	15	16	17	18	19	20	21	22	23	24	25	26	27	28	29	30	31	01	02	03	04	05	06	07	08	09
Mon	Tue	Wed	Thu	Fri	Sat	Sun																																												
29	30	01	02	03	04	05																																												
06	07	08	09	10	11	12																																												
13	14	15	16	17	18	19																																												
20	21	22	23	24	25	26																																												
27	28	29	30	31	01	02																																												
03	04	05	06	07	08	09																																												

Select the Start time and End time buttons and use the Time keypad to enter the report filter start and end times. Select am/pm. Press the Apply button.



Press the Save button to return to the Reports screen.

Select Time

Time

Enter Start Time 00:00:00

pm

1	2	3	delete
4	5	6	
7	8	9	
	0		Apply

Filter Certification Type

Click to Enable the certification type(s) to be included in the filter. The button will highlight green with a yellow check mark indicating that certification Type is included in the data records filter.

Press the Save button to apply the filter and return to the Reports screen.



Select Certification Type Filter

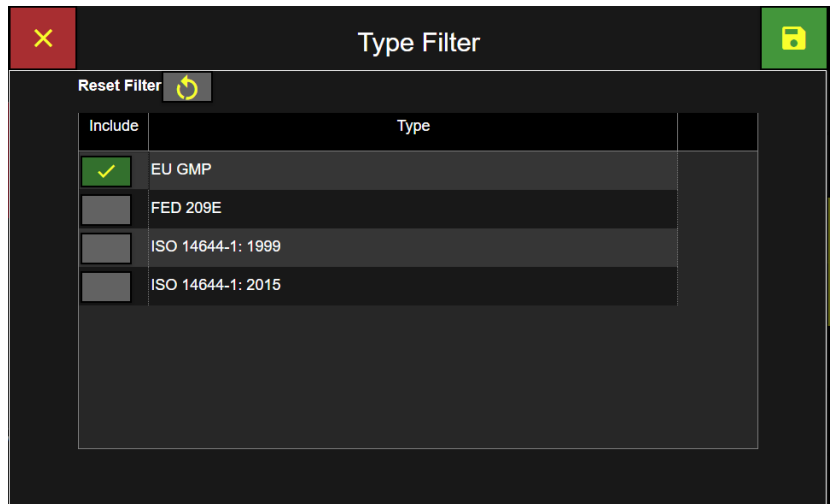

Filter Pass/Fail

Click to Enable the Pass/Fail Type(s) to be included in the filter; Cannot Classify, Fail or Pass.

The button will highlight green with a yellow check mark indicating that type is included in the Report list filter.

Press the button a second time and the button will change to a grey color indicating it is not included in the data records filter.

Press the green Save button to apply the filters and return to the Reports Screen.

Select Pass/Fail Filter

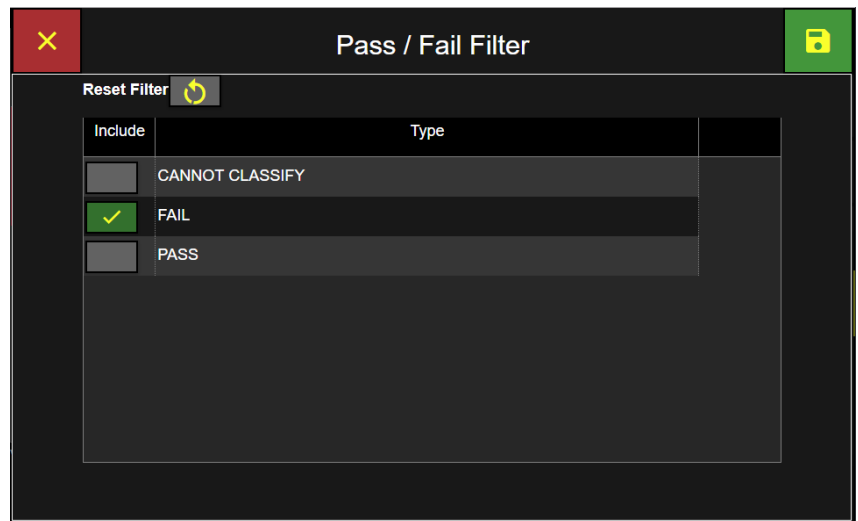

 If you do not press the Save button then no new filters will be applied. If you press the red x button to cancel then no filters will be applied. If no Types are included then no filters will be applied and all Reports will be displayed on the Reports screen.



Note: Press the Reset Filter button to disable all included filters.

Export Report

Select a report to export and it will highlight blue indicating it has been selected.

Press the Export button.



Note only 1 report can be selected for exported at a time.

Select Report to Export

Created	Name	Result		Type	Filter	
		Pass / Fail				
06/28/2019, 1:07:55 pm	Cert 4	FAIL		ISO 14644-1: 2015		
06/28/2019, 1:00:06 pm	Cert 3	FAIL		ISO 14644-1: 2015		Created
06/27/2019, 2:24:20 pm	Cert 2	PASS		EU GMP		Type
06/27/2019, 2:17:49 pm	Cert 1	FAIL		ISO 14644-1: 2015		Pass / Fail

viewing: 4 / 4 data buffer: 4 / 100

Navigation icons: Home, List, Export, Settings, Feed, All, Print, Confirm Export

Export Output

Select the Export type output to Printer, USB (.pdf) or CIFS (.pdf).

Press the Confirm Export button to start the export.



Export

Printer

USB (.pdf Only)

CIFS (.pdf Only)

Close (X) Confirm Export (Up Arrow)

Preparing Data will count up from 0 to 100%

Preparing Data

0 %

USB Export will count up from 0 to 100%

USB Export

100 %

Cancel

Delete a Report

Select a report to delete and it will highlight blue indicating the Report has been selected.

Press the Delete Report button to display the Delete report confirmation screen.



Only 1 report can be deleted at a time. If no reports are deleted then the delete report button will be disabled.

Select Report to Delete

Created	Name	Result		Type	Filter	
		Pass	Fail		Created	Type
06/28/2019, 1:07:55 pm	Cert 4	FAIL	ISO 14644-1: 2015	<input type="checkbox"/>	<input type="checkbox"/>	
06/28/2019, 1:00:06 pm	Cert 3	FAIL	ISO 14644-1: 2015	<input checked="" type="checkbox"/>	<input type="checkbox"/>	
06/27/2019, 2:24:20 pm	Cert 2	PASS	EU GMP	<input type="checkbox"/>	<input type="checkbox"/>	
06/27/2019, 2:17:49 pm	Cert 1	FAIL	ISO 14644-1: 2015	<input type="checkbox"/>	<input type="checkbox"/>	

viewing: 4 / 4 data buffer: 4 / 100

Home Menu Reports Settings Feed All Delete Report Refresh

Confirm Report to Delete

Press the green check box to delete the named Report. Or press the red x box to cancel with no report deleted.

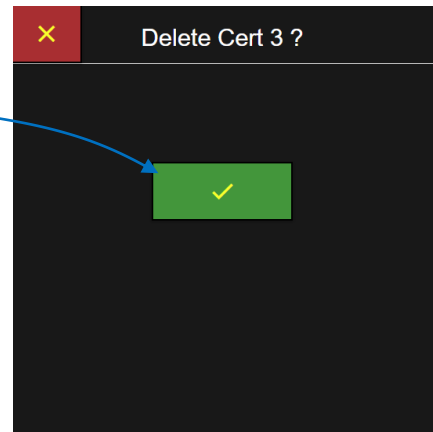

Audit Trail

The Audit Trail Screen creates a timestamp and message for every user action and data record recorded on the ApexZ instrument. Every time a sample is recorded or a user changes a current setting or modifies a configuration parameter; a timestamped message will be recorded in the Audit Trail. After 20,000 records have been recorded in the audit trail the next record will replace the oldest record.

Press the Reports Screen Button

From the Home screen press the Reports button and then press the Audit Trail button to display the Audit Trail Screen.



Press the arrow button or slide the scroll bar up and down to view the audit trial history.

Audit Trail Screen

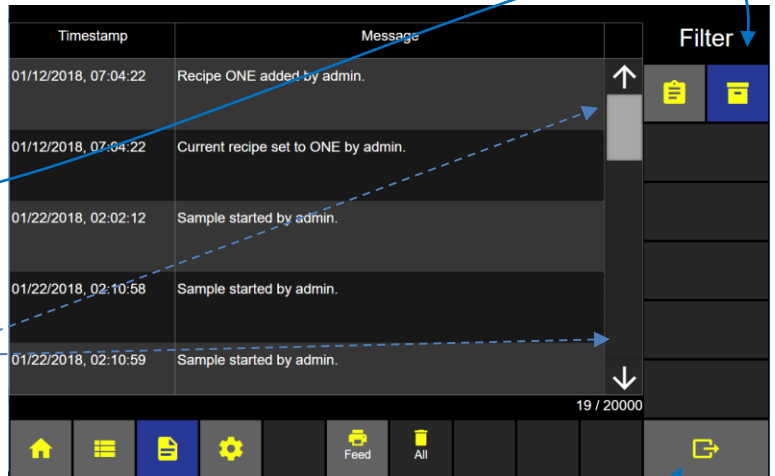

Export Audit Trail to USB or Network drive

Press the Export button to export the Audit Trail.



Select export to USB or Network.



Press the Export button.

If a USB key is inserted then a pop up message will display saying “Preparing Data” and “USB Export” each will count up from 0 to 100%.

The USB file will be saved on the USB key in .CSV format and named: **Audit_YYMMDD_HHMMSS_ApexName.csv**

Export Audit Trail

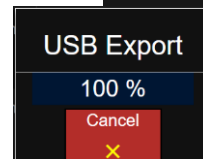
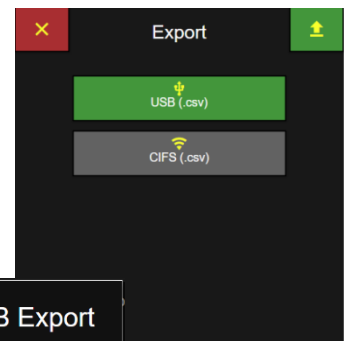

Settings

Settings are used to create locations, groups, presets, sample plans and certifications. In addition instrument settings, connectivity, users and service are managed from the Settings screens.

The Settings gear button will only be available to “Admin” level User logins. When a “Power User” or “Operator” level username is logged in; the Settings gear button will be disabled and the operator logged in will not have access to any of the settings screens. If Users are disabled then the settings button and screens will be active and accessible to any user.

From the Home screen press the Settings gear icon to display the settings screen button list for Location, Preset, Sample Plans, Certifications, Users, Connectivity, Instrument and Service.

Select a settings button from the right column and that settings screen will highlight blue to indicate it has been selected and is being displayed. In the example below the Location button is highlighted blue and the Location screen is displayed.

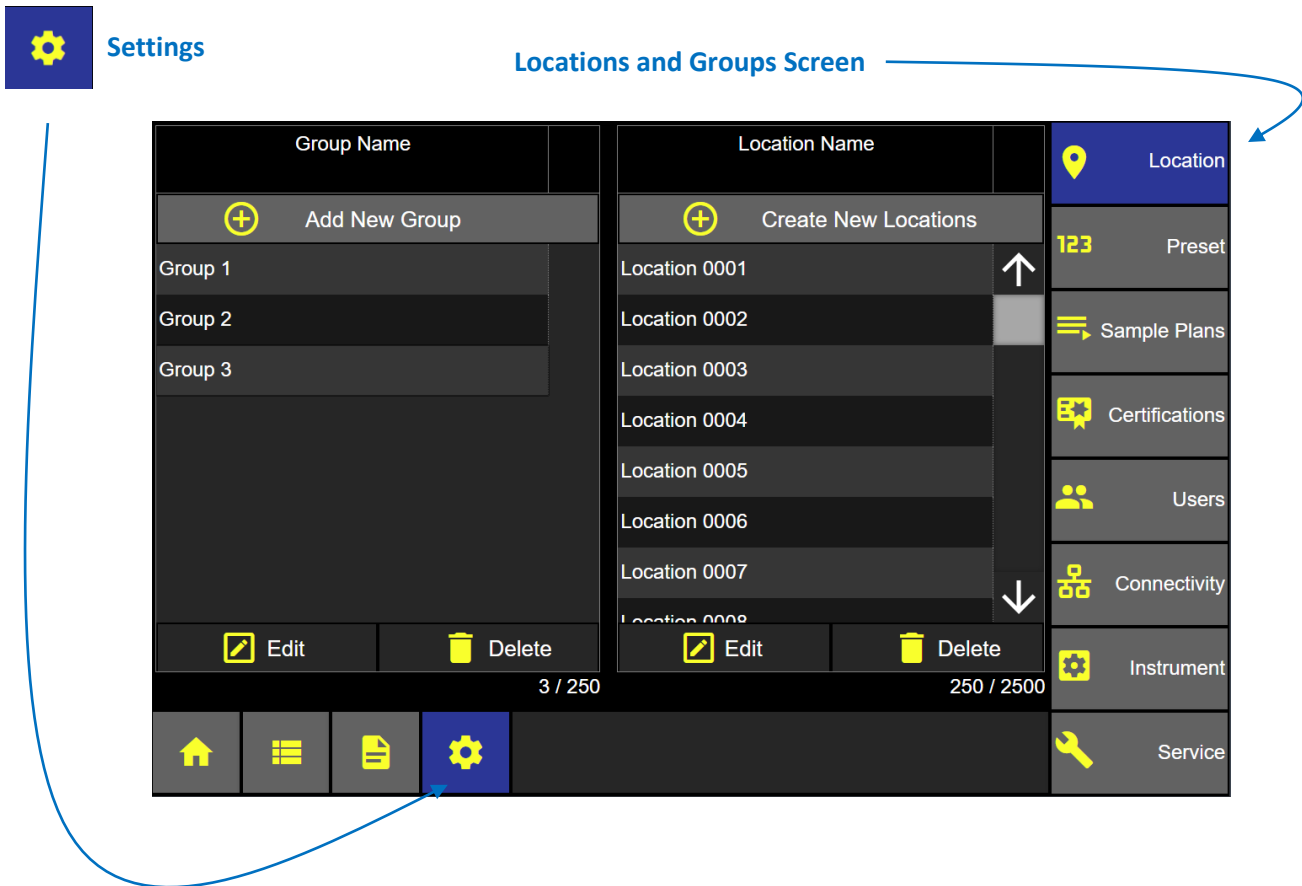

Blank Page

Instrument Settings

The Instrument Settings screen allows the user to view and edit options and settings for date/time, audio/visual, global channels, warning/alarm data count format and units, sample and zero count settings, data output and formatting, saving and loading configurations files.

Access the Settings Screen

From the Home screen press the gear icon to display the settings screen.



Home Screen

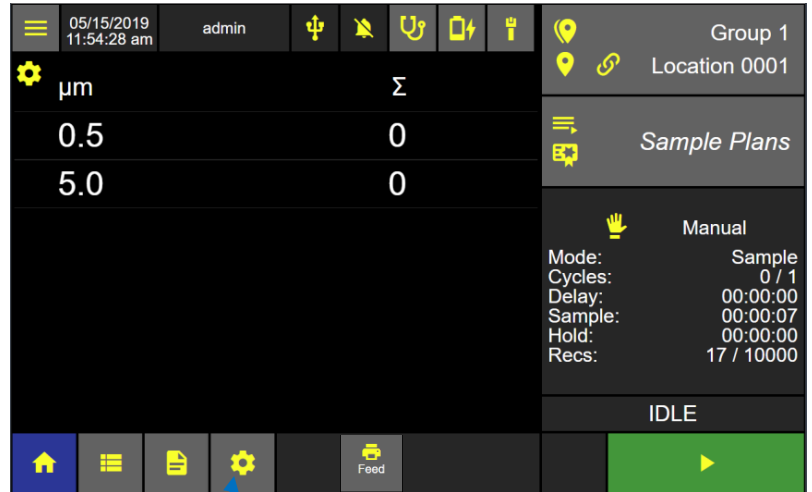

Access Instrument Settings

From the Settings screen press the Instrument button to display the Instrument Settings screen.

Note: The Settings Screen defaults to the Location button selected and the Groups and Locations screen displayed.

Settings: Groups and Locations

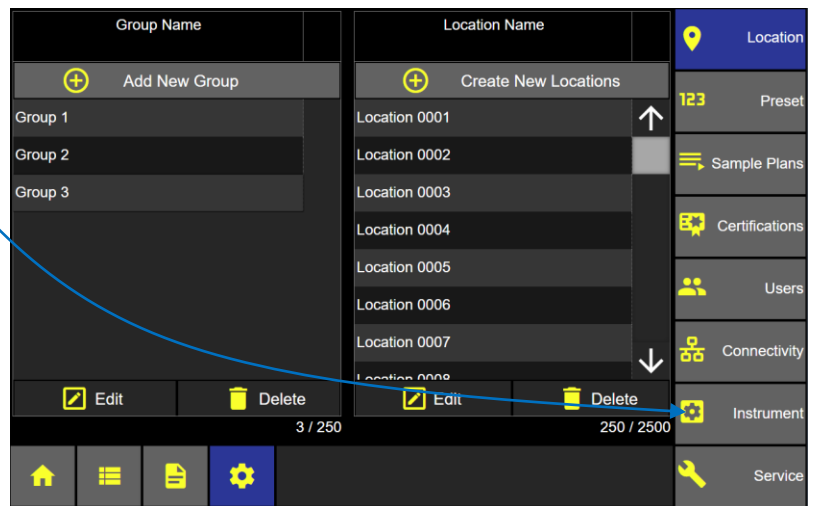

Time & Date

Press the Time button to edit the date, date format, time zone, time and time format.

Instrument Settings Screen

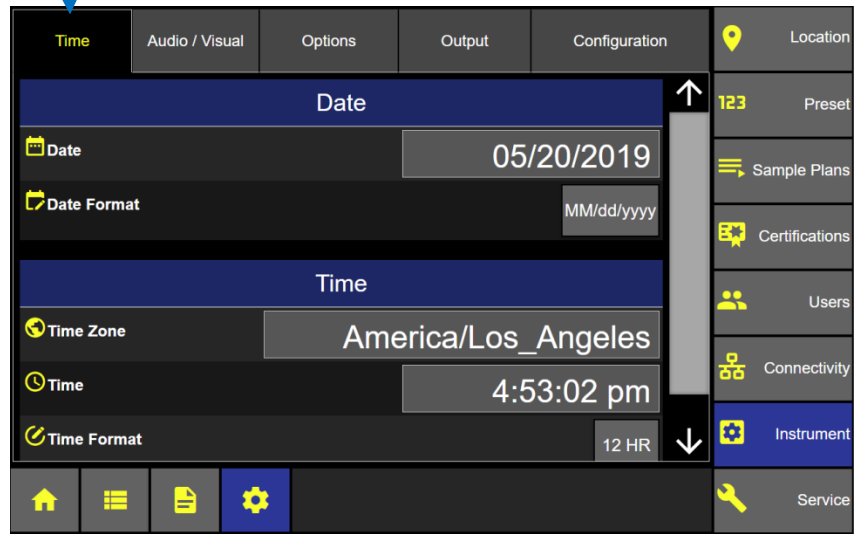

Set Current Date

Press the Date button to display the Pick Date screens

Pick Date (month/day)

Select today's day, month and year.

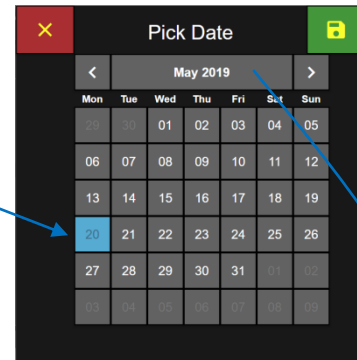

Select the green save button to save the date settings.



Or press the red x button to cancel.



Pick Date (year/month)

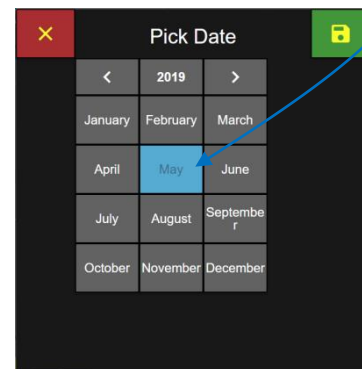

Set Date Format

Select the Date Format button to display the Select Date Format screen.

Instrument Settings: Date and Time

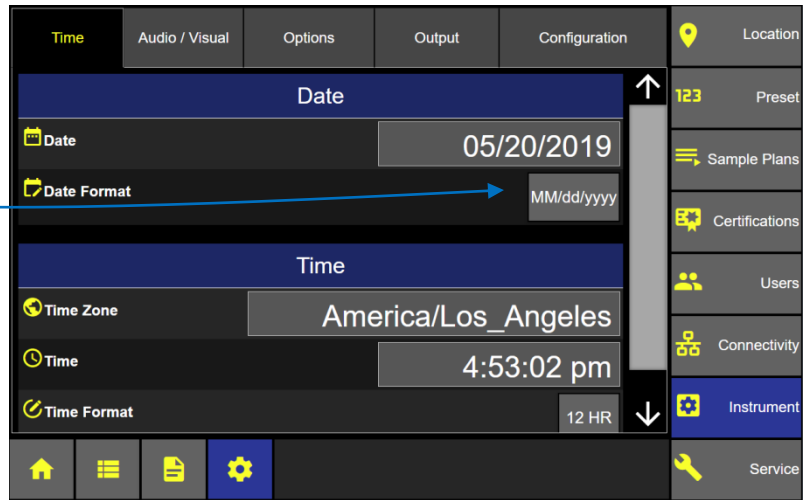

Select Date Format

MM/dd/yyyy
DD/MM/yyyy
yyyy-MM-dd

Select Date Format screen

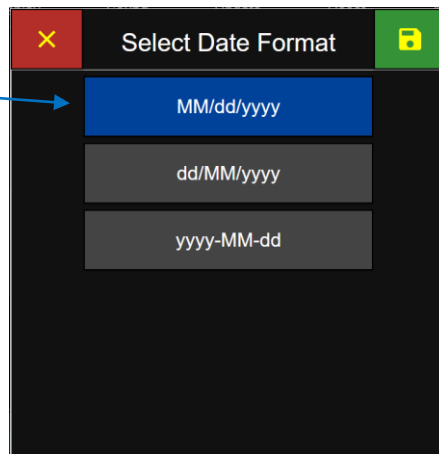

Press the green save button to save the date format setting.

Set Time Zone

Press the Time Zone button to display the Select Time Zone screen.

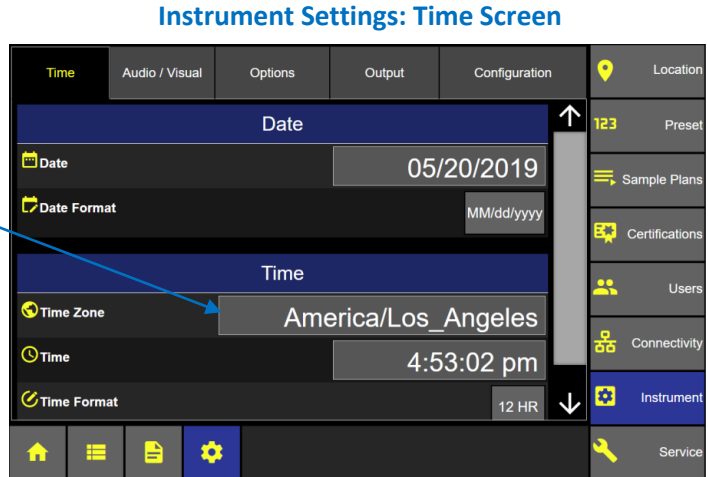

Press and select your UTC-Time Zone.

Select Time Zone screen

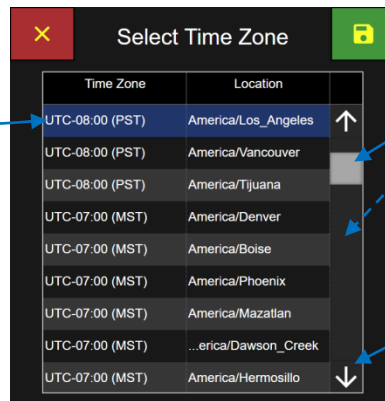

Press the green save button to save the UTC-Time Zone.



Click and drag the scroll bar to scroll up and down the Time Zone List.

Or click on the arrow to scroll.

Set Current Time

Press the Time input button to display the Enter Time keypad.

Instrument Settings: Date and Time Screen

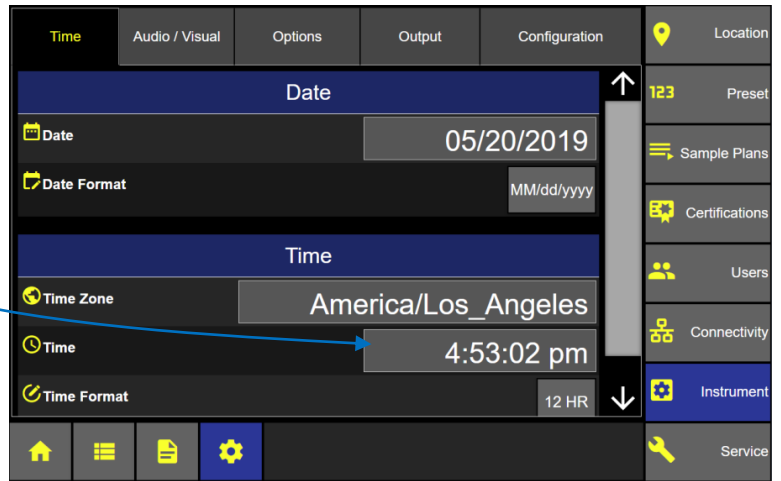

Enter the current time from the numeric keypad as HH:MM:SS
Select am or pm from the toggle button.

Press the green Apply button to save the current time entered.

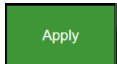

Enter Time keypad

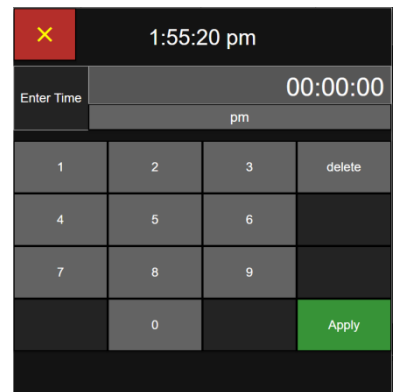

Set Time Format

Press the Time Format button to toggle between 12 or 24 hour time format.



Note: If 24 HR time format is selected then no am/pm will be displayed.

Instrument Settings: Time Format

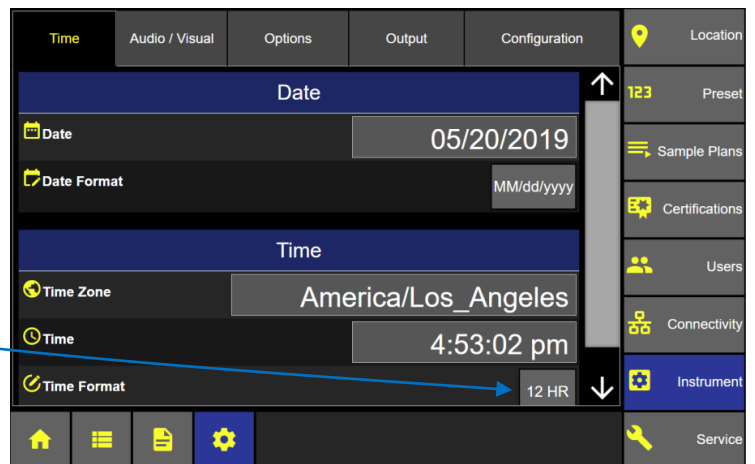

Audio/Visual

Volume

Touch and slide the volume button from 0 – 100%.

Brightness

Touch and slide the brightness button 0 – 100%.

Note: Enabled Alarms will always sound at 100%.

Instrument Audio/Visual Screen

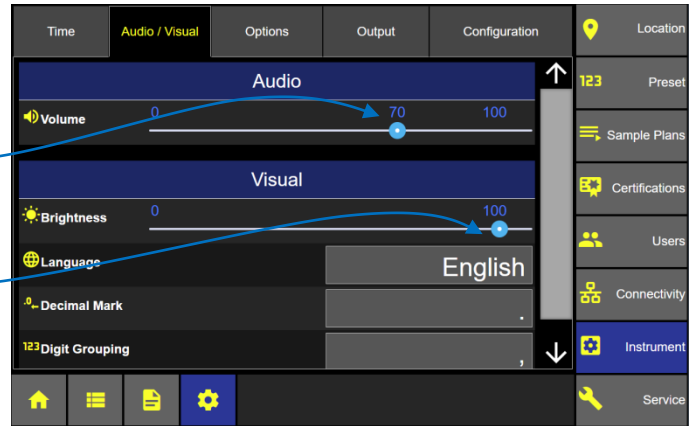

Language

Press the Language button to display the Select Language screen.
Select the desired language.



Press the green save button.

Select Language Screen

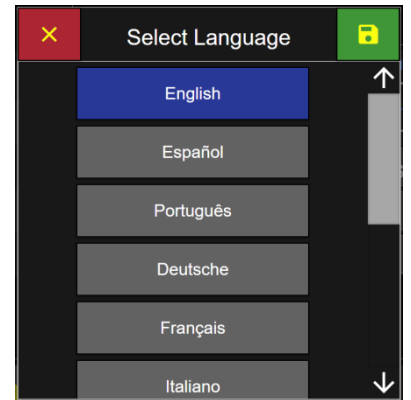

Warning: Changing the instrument language will update the instrument firmware and the printer. It will take 1-2 minutes for the update to complete. During this time make sure the ApexZ instrument has at least 50% battery life remaining or connected to the AC adapter and do not turn off the instrument while updating. Failure to follow these instructions could cause the printer to become damaged and unusable.

Decimal Mark

Press the Decimal Mark button to display the Select Decimal Mark screen.
Select period or comma.
Then press the green save button.

Select Decimal Mark Screen

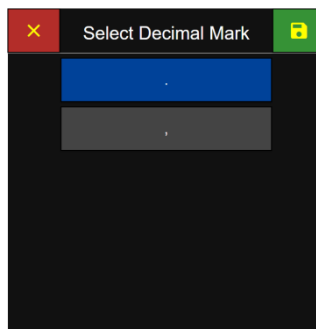

Digit Grouping

Press the Digit Grouping button to display the Select Digit Separator screen.
Select none, space, comma or period.
Then press the green save button.

Select Digital Grouping Screen

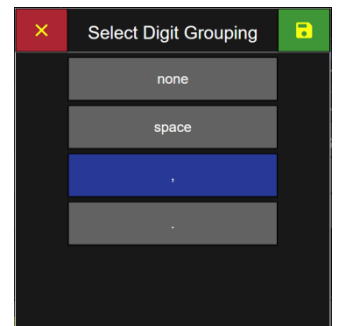

Options

Instrument Options

Lock Global Channels

ApexZ can lock specific particle size channels globally for all manual samples, preset samples, and sample plans. For example the user can lock channels globally for the 0.5µm and 5.0µm channels and then for all new samples (manual, sample plan, or presets) only 0.5µm and 5.0µm channels will be sampled and those particle size channels counted. Certification Samples are not affected by Locked Global Channels being enabled. Certifications will always use the channel sizes required from the certification standard.

How to Lock Global Channels

Click on the Global Channels buttons to display the edit Global Channels pop up screen.

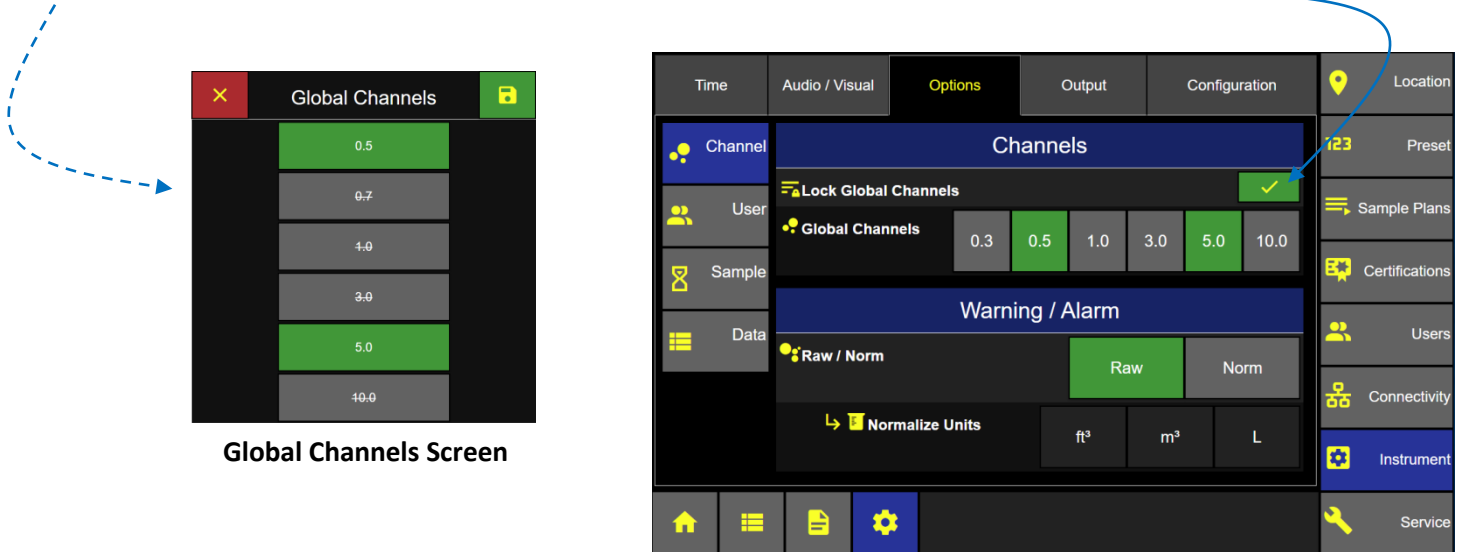

Global Channels Screen

Global channels highlighted in green are ENABLED. Global channels highlighted in grey with ~~strike through~~ text are DISABLED. Press any green channel button and it will highlight grey with ~~strike through~~ text to indicate this channel has been disabled. Press any grey button and it will highlight green indicating it has been enabled.

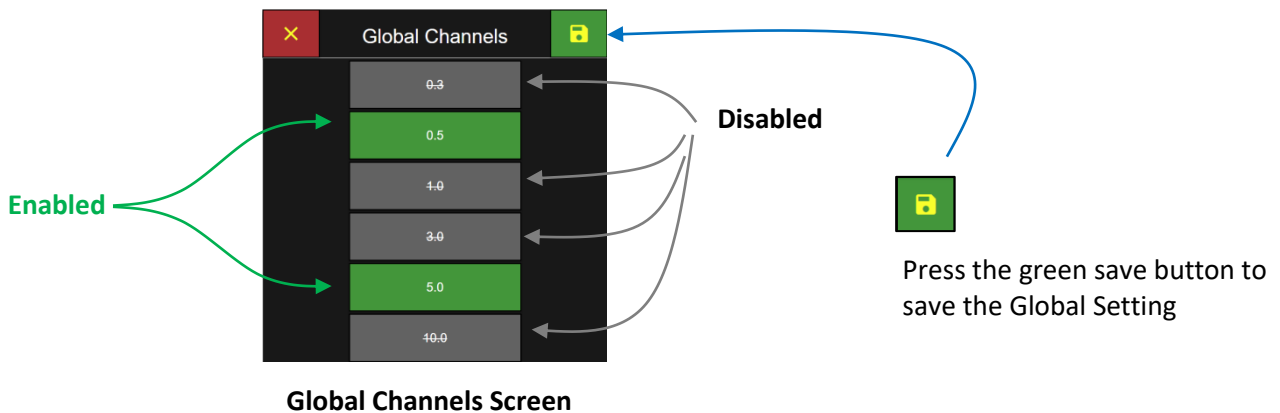

Global Channels Screen

Note: If Lock Global Channels is disabled then all particle channels will be counted and recorded.

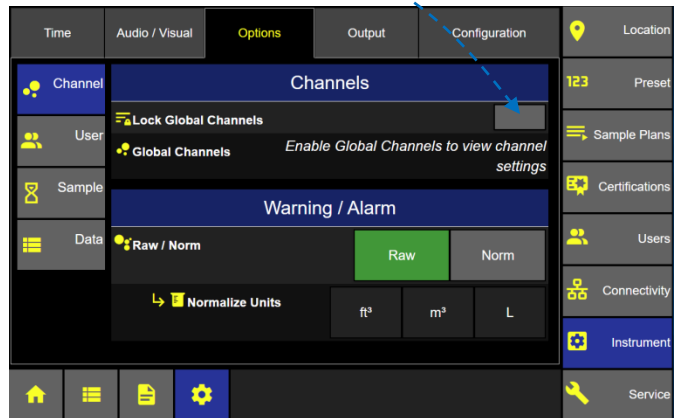

Global Channels

Warning/Alarm

Select either Raw or Norm (Normalized) particle counts for the warning and alarm limits.

Raw displays total particles counted over time.

Norm displays normalized counts per unit of measure.

If normalized is selected then select normalized units: ft³/m³/L.

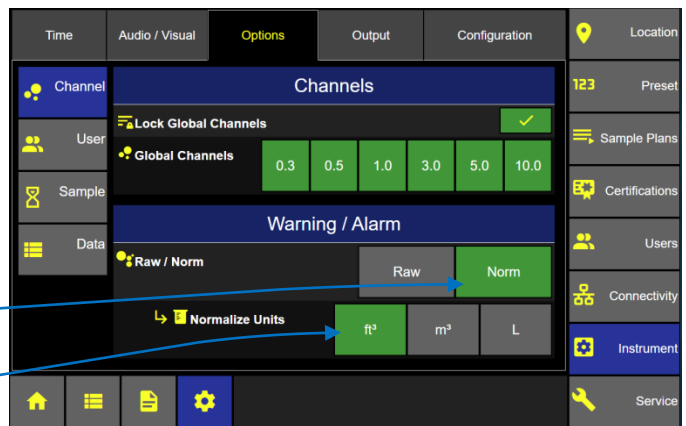

Tool Tips: Lock Global Channels

Click on the icon/label “Lock Global Channels” and a brief description of that feature will appear.

Tool tips are included for icon/labels included in:

Instrument: Options, Output and Configuration

Connectivity: AD/LDAP and CIFS input screens

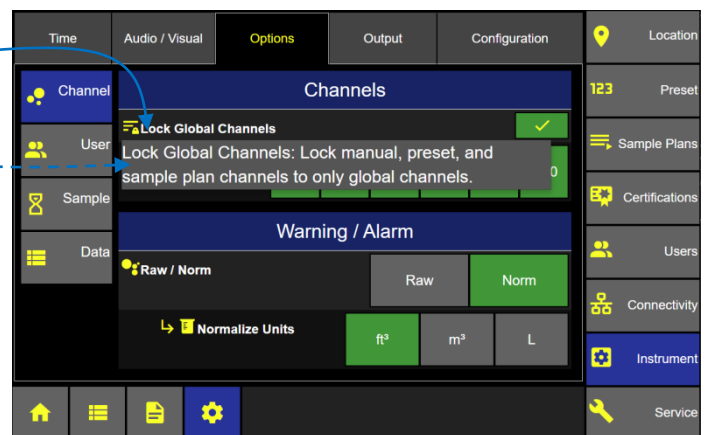

User Options

Enable Users (enable/disable)

Press the Enable Users button and go directly to the Login Screen and require a User Login. Note to login to ApexZ at least one “local” Administrator level user must have been created prior.

AD Groups (enable/disable)

Enable AD Groups to assign active directory groups to an ApexZ permission levels.

Local Password Cache (enable/disable)

Enable local password cache to save passwords locally on ApexZ when Active Directory Server is unavailable.

Enable Guest Account (enable/disable)

Press to enable guest account and then a guest user will be permitted to login without a password and will be assigned the default “Operator” level read only access. Only an Admin level user can enable the guest account feature.

Auto Lock (enable/disable)

Press to enable Auto Lock and automatically lock the screen after the timeout period.

Timeout

Enter the timeout period to lock the screen when auto lock is enabled.

Include Sample Time (enable/disable)

If Include Sample Time is enabled then the timeout timer will countdown during idle screen time or while sampling. If “Include Sample Time” is disabled then the timeout timer will not count down during a sampling session.

Login Retry (enter login retry limit)

Set the number of times ApexZ will allow a user to retry failed login attempts. After the login retry limit has been exceeded ApexZ will lock out further login attempts and start the Account Lock Duration countdown time. During the Account Lock Duration time period ApexZ will not allow user login. After the Account Lock Duration time period has been exceeded then ApexZ will allow user login again.

Account Lock Duration (enter account lock time duration period)

After login retry is exceeded, ApexZ user login will be locked for the Account Lock Duration time period set here.

Instrument Options Enable Users

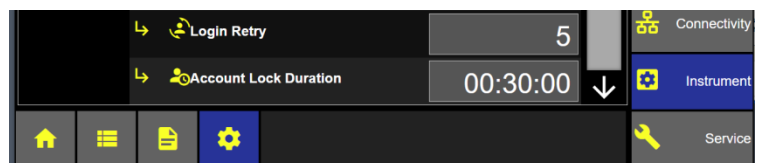
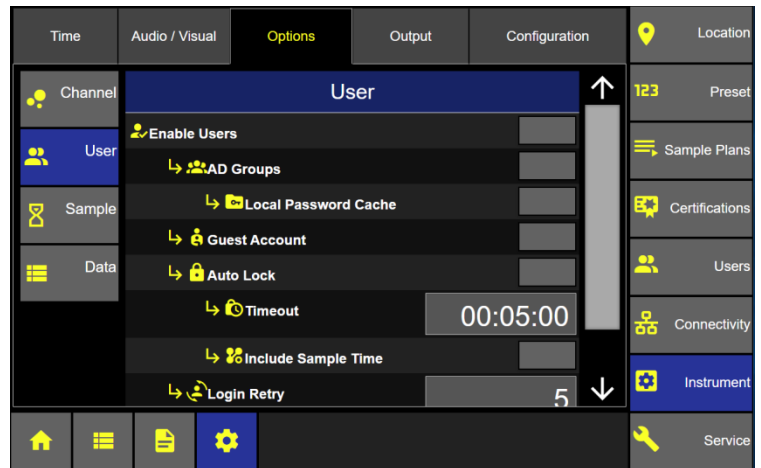

Unlock screen from Auto Lock

Press the User Button to unlock user screen.

Then select

- Switch User (new login required)
- Unlock (password required)
- Cancel (remain locked)

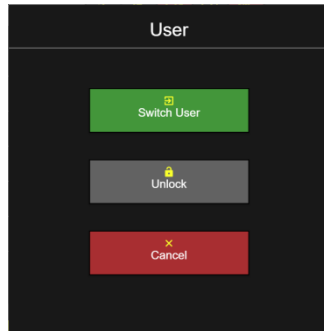

Home Screen - Auto Locked

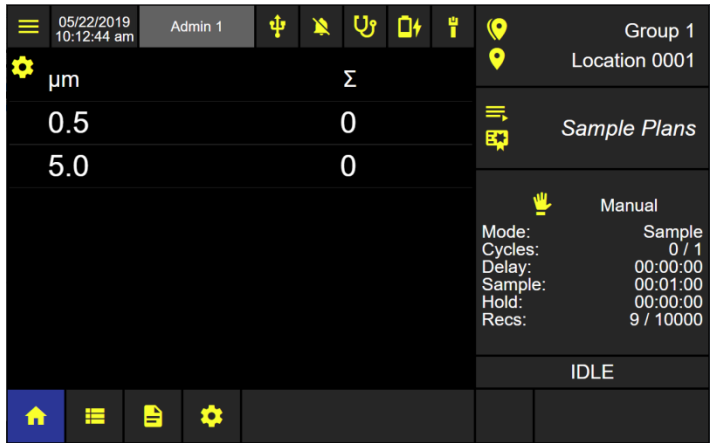

Note: All buttons disabled during auto lock.

Sample Options

Auto Pump Start

When Pump Startup Disabled: The ApexZ pump will start up after the sample Delay time has expired.

When Pump Startup Enabled: The ApexZ pump will start immediately after pressing the sample Start button.

Disable Sample Abort

When Enabled, "Disable Sample Abort" will not allow a sample that has been started to be stopped. When Disabled, any sample may be stopped at any time.

Instrument Options: Sample

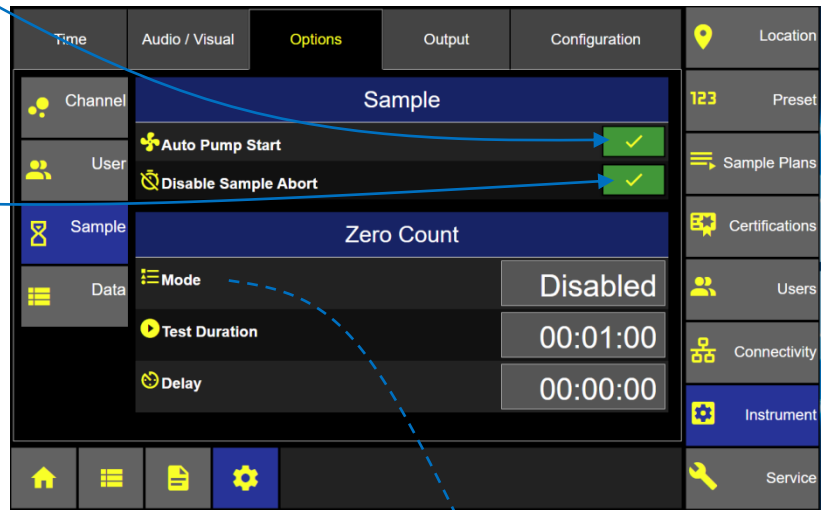

Zero Count Options

Mode: Press the Zero Count Mode button to select one of the following 3 modes.

Disabled: The zero count button will be inactive and will not display.

Manual: Zero count button will display and run for the sample time when pressed.

Auto: In Auto mode, zero counting will be successful after sustaining a 6 second rolling average particle count = 0 for the duration of the zero count sample time period.

Zero Count Mode

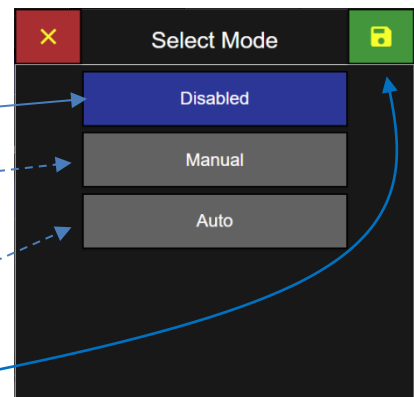

Then press the green save button.

Instrument Options: Zero Count

Test Duration

Press the Test Duration button to enter your desired zero count sample time with the pop up numeric keypad.

Delay Time

Press the delay button to enter the desired delay time.

Delay Time will start after pressing the zero count start button on the Home screen. The Zero Count Sample time will start immediately after the delay time is completed.

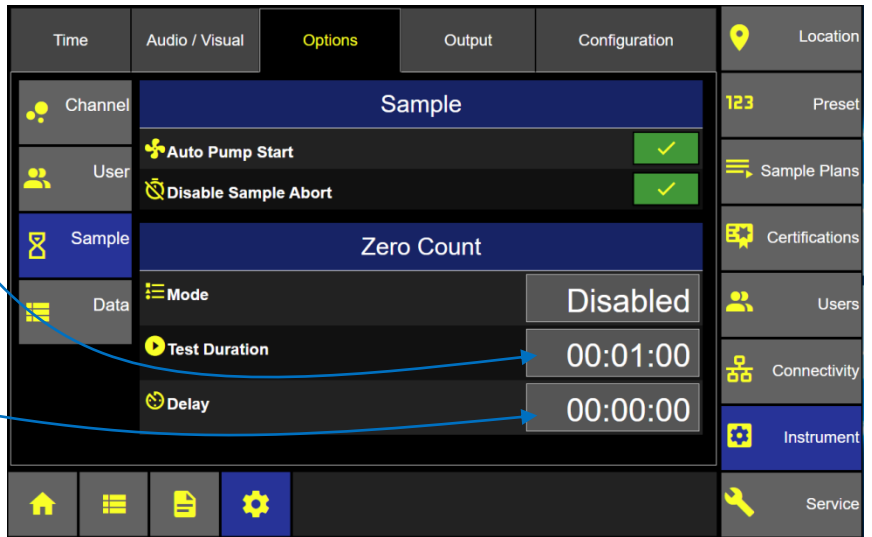

Data Tag Name Options

Data tags are set up in the Instrument Settings Options Data screen. ApexZ supports up to 5 unique data tags.

Data Tag Name

An example of a data tag name could be “Batch #” or “Lot #”.

In the example below Data Tag names “Batch #” and “Lot #” have been created.

Add New Data Tag

Press the Add New Data Tag button and the New Data Tag screen will display.

Prompt: Enable the Prompt feature to force a prompt to appear and request to enter a data tag value.

When: Select Either Pre Sample or Post Sample.

Select “Pre Sample” and the data tag prompt will appear when the start button is pressed before a sample starts.

Select “Post Sample” and the data tag prompt will appear after the sample has completed and stopped.

Allow Bypass: Enable this feature to allow the user to bypass entering the data tag prompt when it appears. User will be allowed to enter the data tag value later in the data record screen.

Note: Bypassing a data tag prompt will be noted in the Audit Trail.

Apply to Certifications: Enable Apply to Certifications to prompt for data tag entry when running certifications.

Lock Entry: Enable Lock Entry to lock the data tag entry on the data record the first time it is set. With Lock Entry enabled no data tags may be modified once they have been set.

Note: If a data tag has been bypassed, user can still set the data tag value in the data record screen. Once the data tag has been set, then the value is locked and cannot be modified.

Barcode Scanner

ApexZ supports data tag input through a standard USB barcode reader connected through the ApexZ USB port. Once the USB scanner is connected, a barcode icon will appear on the home screen header.

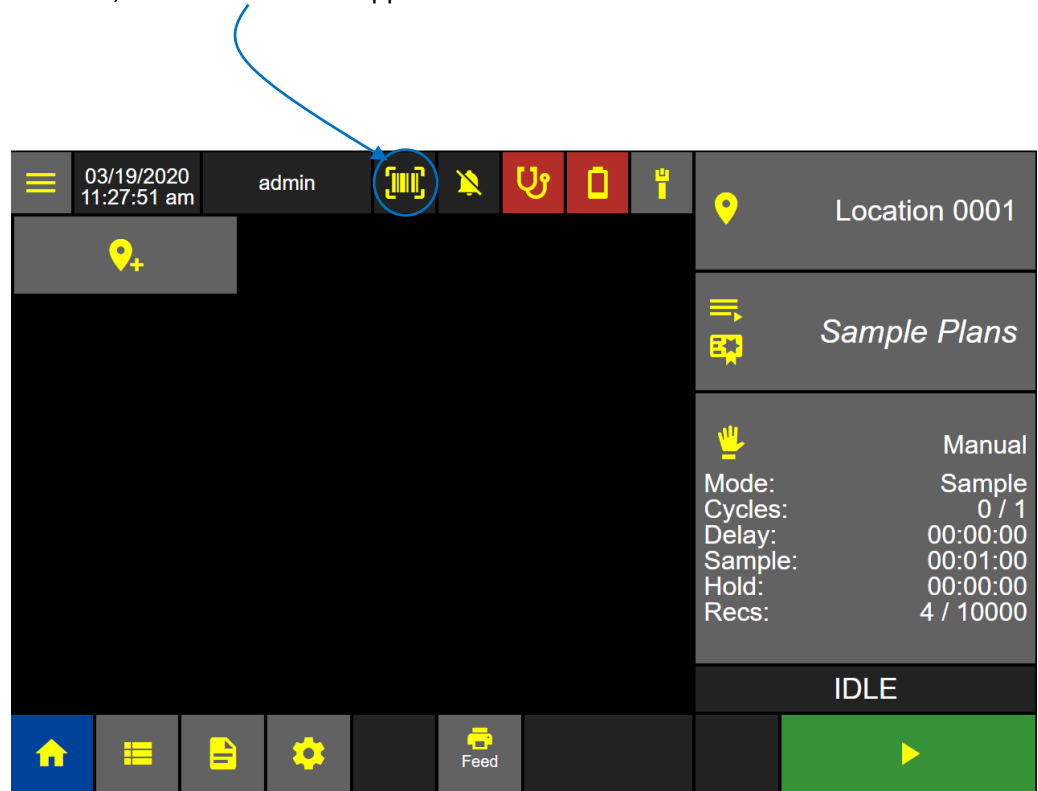

Data Tag Name

Press the Name tab and

Enter the new Data Tag name using the keypad

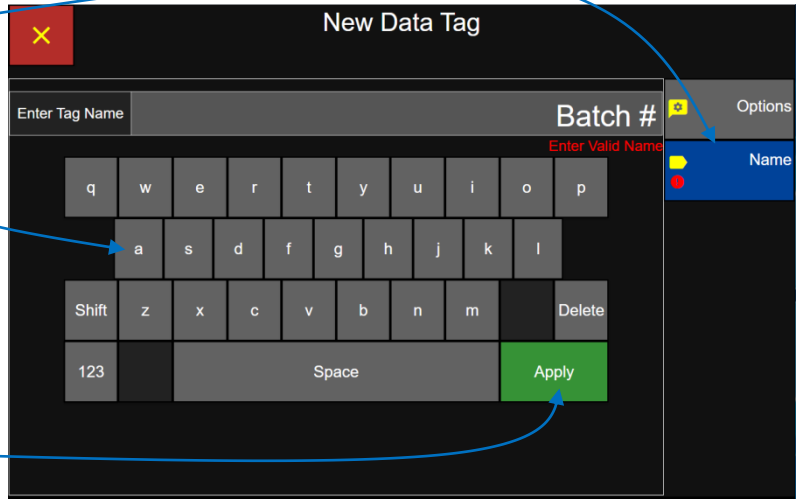

Then press the green Apply button.

Enter New Data Tag Name Screen

The screen will change to the New Data Tag confirmation screen.

Press the green Save button to save the new data tag name.

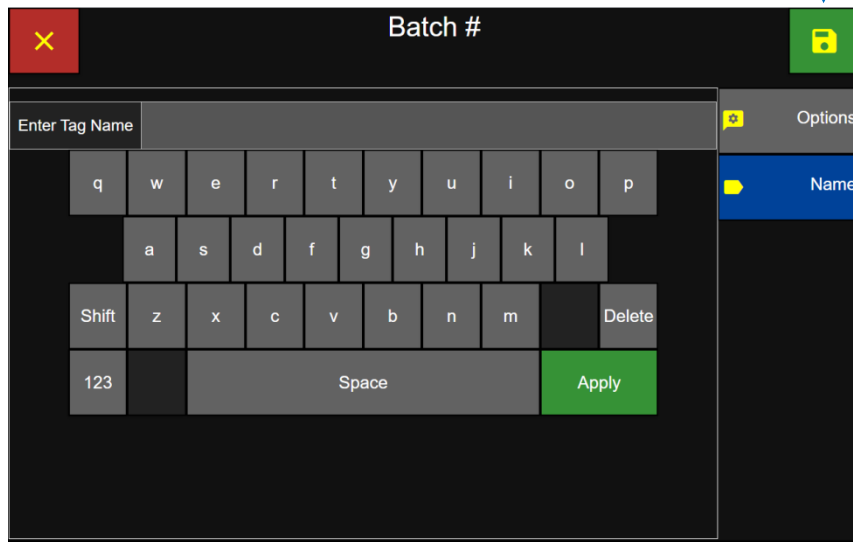

Save New Data Tag Name Screen

Edit Data Tag

Select a Data Tag name and it will highlight blue indicating it has been selected.

Press the Edit button and this will display the Edit Data Tag Name screen.

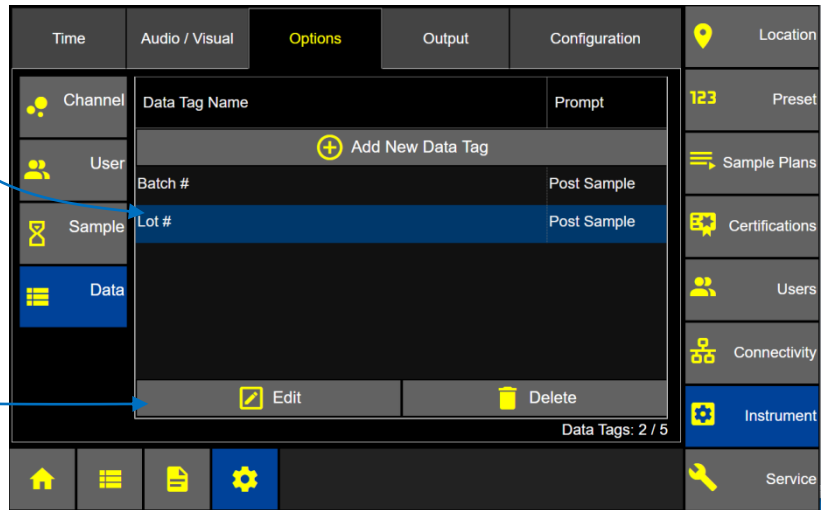

Edit any of the data tag parameters:

- Prompt When**
- Allow Bypass**
- Apply to Certifications**
- Lock Entry**

Press the Name tab to edit the data tag name.

Edit the name of the data tag using the keypad.

Press the green Apply button.

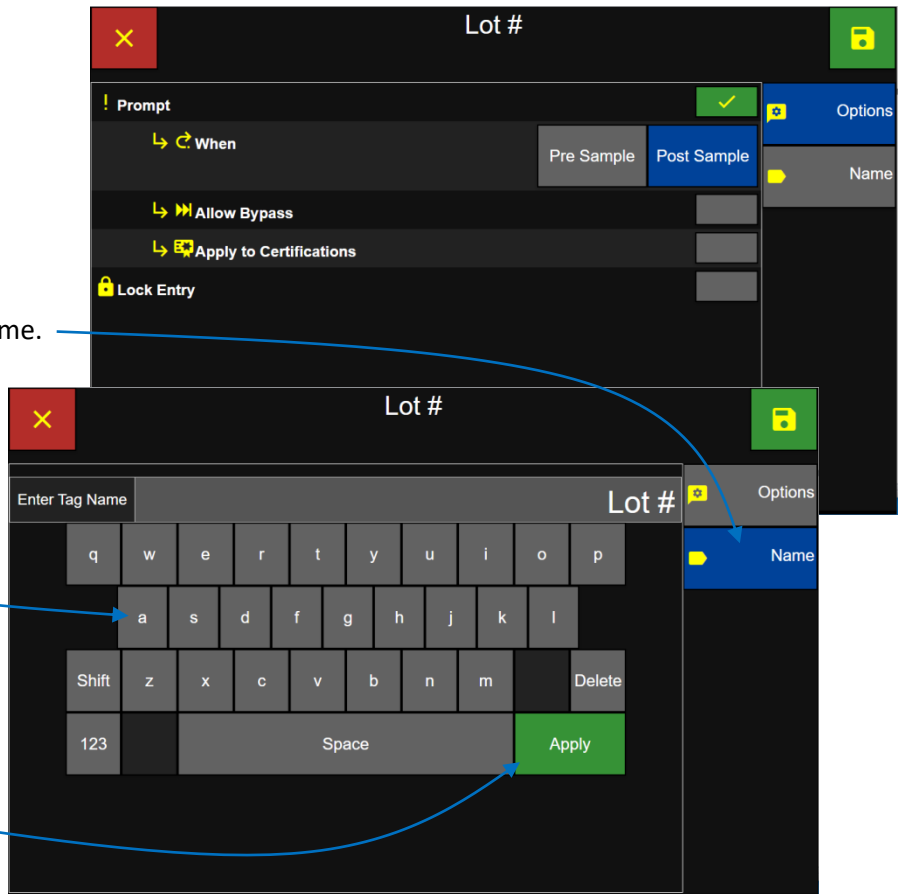

Delete Data Tag

Select a Data Tag name and it will highlight blue indicating it has been selected.

Press the Delete button to display the Delete data tag confirmation screen.

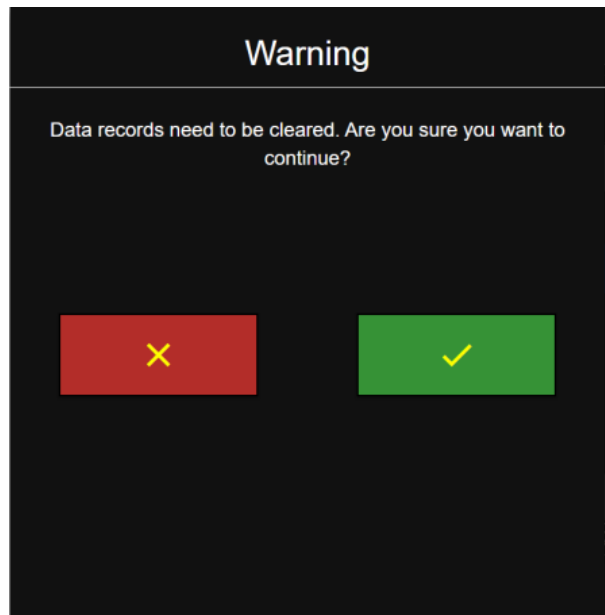
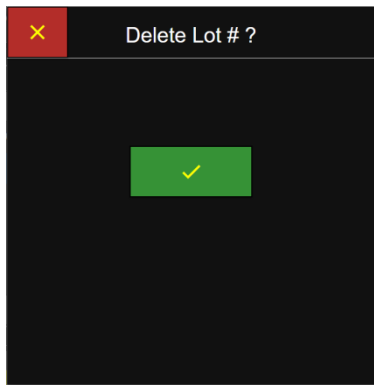
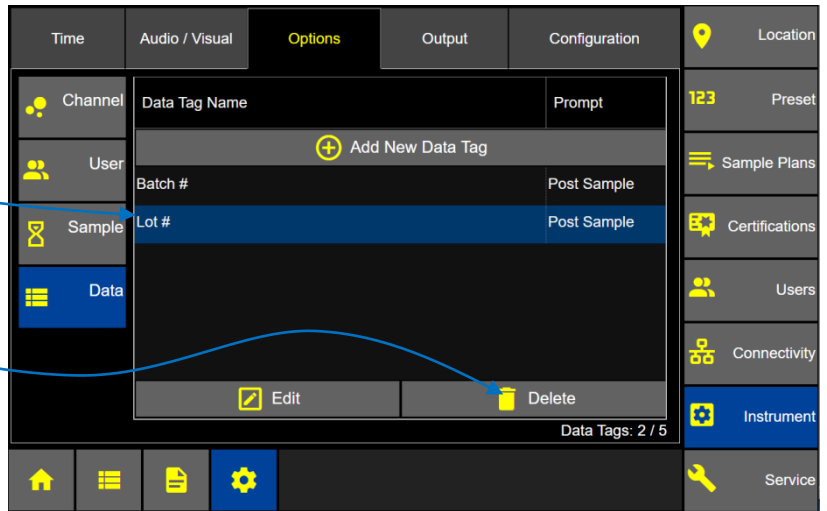

Warning: Data records will be cleared when any data tag is added, data tag name is edited, or deleted while there is data records in the data buffer. Press the red X button to cancel and not to delete any data or Press the green check button to confirm data records will be cleared to continue.

Output

The Output screen allows the user to adjust output settings and data formatting for USB, Print, CIFS in addition to Save and Load Configuration.

Instrument Options: Output

USB

Press the USB button to display the Data Output and Formatting.

File Format

Set the file format to .csv, .Isdx or .pdf. Data and reports output to USB will be saved in the selected format.

On Sample (.csv format only)

Enable Output "On Sample" and output will initiate after every sample.

On Alarm (.csv format only)

Enable Output "On Alarm" and output will initiate after every alarm is exceeded.

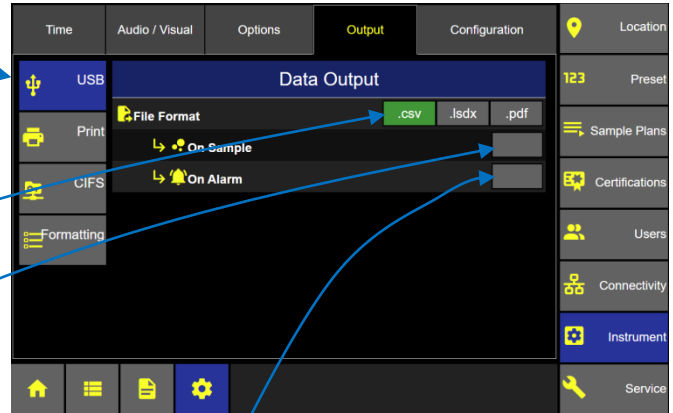

Print

On Sample

Enable Output "On Sample" and output will print after every sample is completed.

Average

Enable Average to print the average counts of all cycles at a given location after all cycles have completed.

On Alarm

Enable Output "On Alarm" and output will print after every alarm is exceeded.

Reverse

Select Reverse and printing will print from the bottom up.

Font Size

Select Large or Small font size for print output.

Instrument Options Output

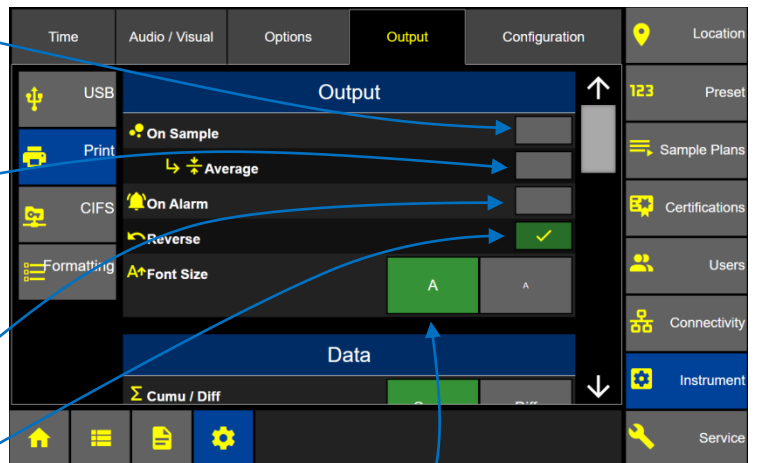

Print Data

Select to print data either Cumulative, Differential or both.

Select to print Raw or Normalized data with normalized units.

Instrument Output Print Data

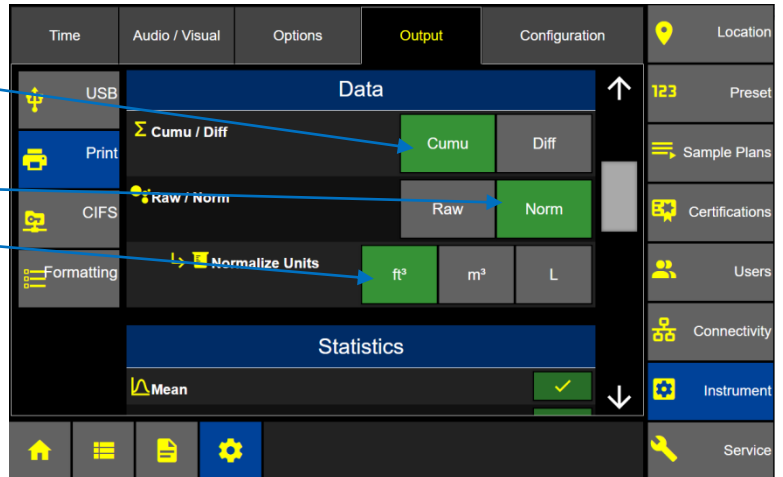

Print Statistics

Enable or disable statistics to print:

- Mean
- Minimum
- Maximum
- Std. Dev.
- Std. Error
- 95% UCL

Enabled parameters will print on the output.

Instrument Output Print Statistics

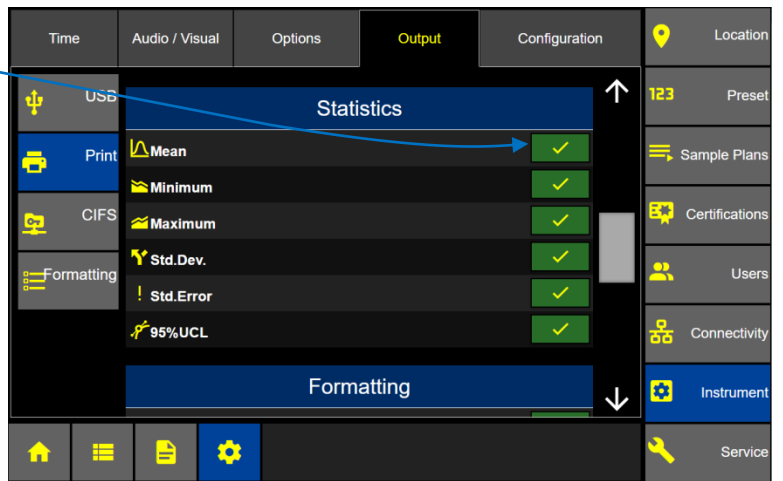

Instrument Output Print Formatting

Print – Formatting

Select to enable print formatting for:

- Model
- Serial #
- CalDate (calibration due date)
- User Name
- Data Tags

Enabled parameters will print on the output.

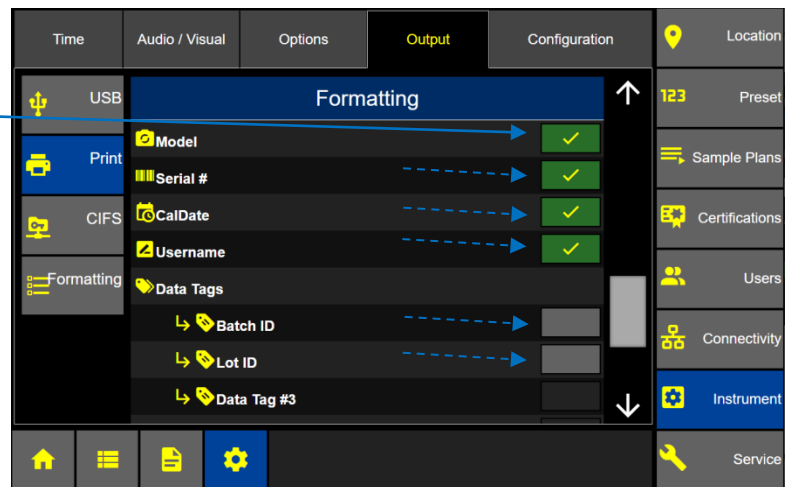

Print Formatting continued

Select to enable and include in print output.

- Data Tags**
- Separator**
- Company**
- Address**

Note: Undefined data tags will be listed but disabled. In the example Data Tag #3, #4 and #5 have not yet been defined. See Instrument Options Data tab to create and edit data tags.

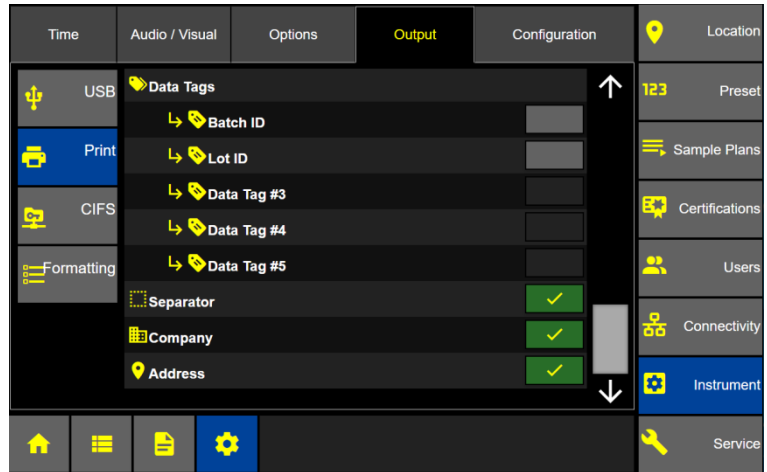

Instrument Output Print Formatting

CIFS

Common Internet File System

Select the CIFS button.

File Format .CSV

Select .csv file format and the options to include audit trail and clear data buffer will be displayed.

Include Audit Trail

Select Include Audit Trail and all audit trail records will be included in the output.

Clear Data Buffer

Select Clear Data Buffer (only valid when exporting ALL data) and after the data file has been successfully copied to the CIFS share then the ApexZ instrument database will be cleared. If the data exporting fails then the ApexZ database will not be cleared.

File formats .lsdx and .pdf

Select .lsdx (Lighthouse Secure Data Transfer), or .pdf and Outputs to CIFS will be saved in the highlighted format.

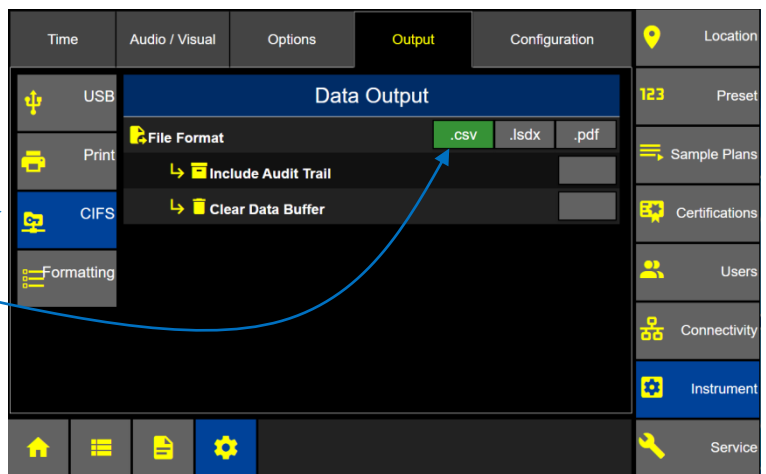

Instrument Output CIFS

Formatting

.CSV output format

Press the Formatting Tab to edit .CSV and .PDF formatting parameters.

Raw / Normalized data format

Select Data Format as Raw, Normalized or both.

When selecting Normalized also select the Normalize Units (cubic feet, cubic meters or Liters).

Note: Once .CSV output formatting is configured, all .CSV files will have this formatting when exported to USB or CIFS.

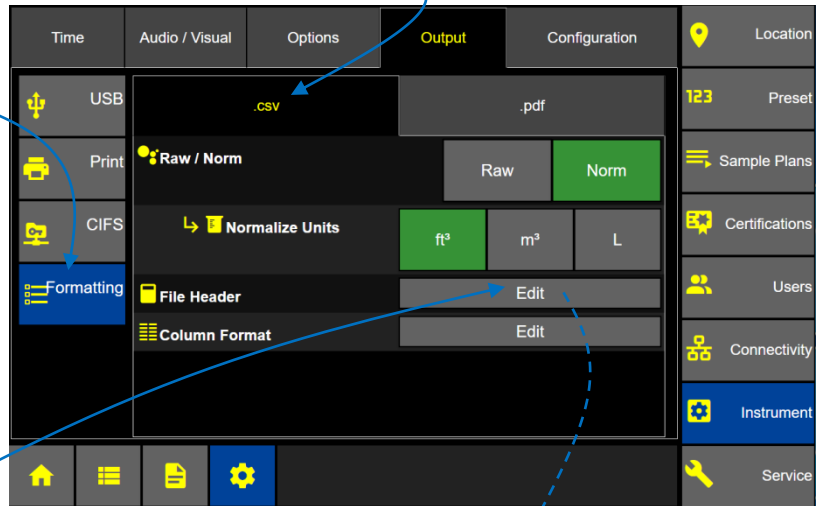

File Header

Press the File Header Edit button to enable/disable or edit custom file headers output to the .CSV file.

By default all File Header System names will be listed on the left column and highlighted blue indicating they are all selected. A matching Custom Name will appear on the right side of the screen.

Select a highlighted System Name and the highlight will disappear indicating that system name is inactive and the matching Custom Name will be removed and will not appear on the list of Custom Names. Select the inactive System Name and it will highlight blue and a matching Custom Name will appear on the Custom Name list on the right side of the screen.

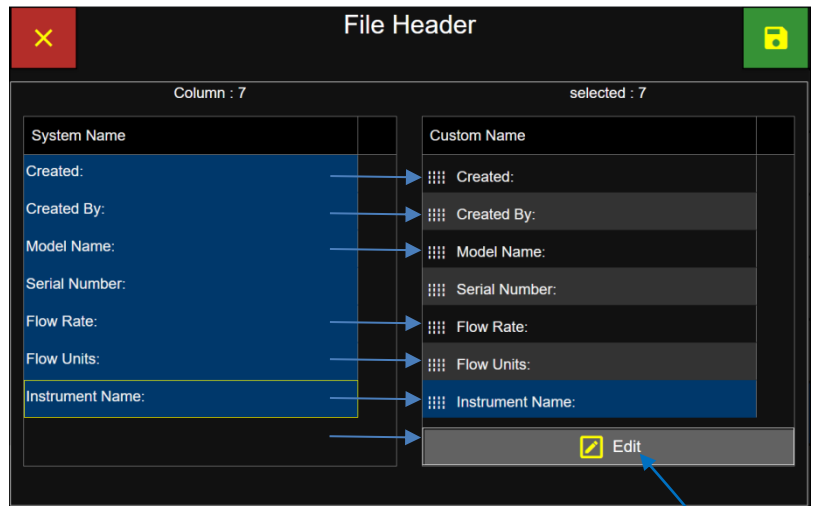

Adjust Custom Name order on the list

To adjust the order of Custom Names press and hold the dotted box to the left of each custom name on the list. Drag the custom name either up or down to change its position.

Edit Custom Name

Press the Edit button to display the Enter Custom Name keypad. Enter a new custom name and press the green Apply button to save the custom name to the file header settings.

Column Format

Press the Edit Column Format button to enable/disable or edit custom name data columns output to the .CSV file.

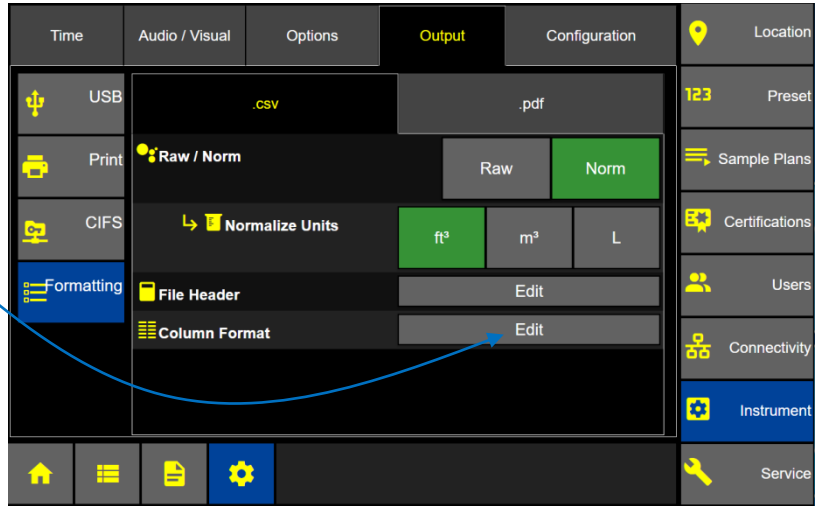

By default Column Format System Names will be listed on the left column with names highlighted blue indicating those are selected. A matching Custom Name will appear on the right side of the screen.

Some System Names may be grey and not highlighted blue. This indicates they are available but not selected for output.

Select a System name to enable (highlighted blue) or disable (grey no highlight). Enabled System Names will appear on the Custom Name list on the right side of the screen. Disabled System Names will not appear on the Custom Name list.

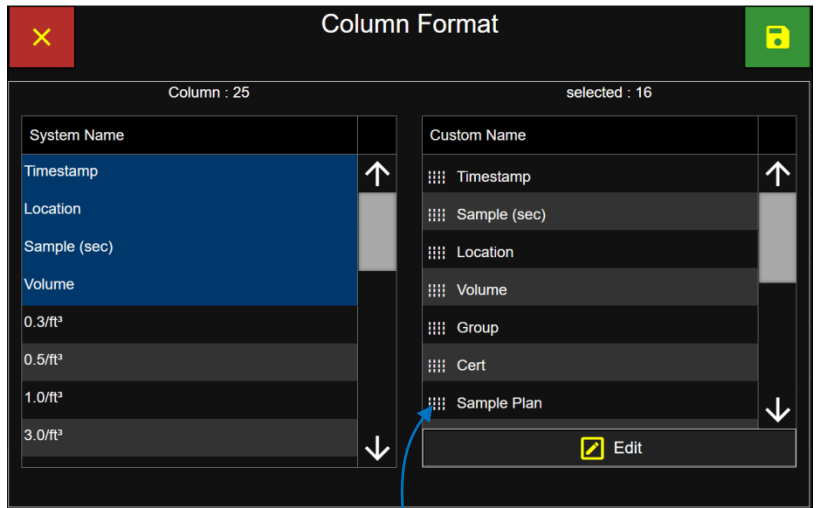

Adjust Custom Name order on the list

To adjust the order of Column Format Custom Names press and hold the dotted box to the left of each custom name on the list. Drag the custom name either up or down to change its position.

Edit Custom Name

Press the Edit button to display the Enter Custom Name keypad. Enter a new column format custom name and press the green Apply button to save the custom name to the column format settings.

.PDF Output Format

Select Raw or Normalized data counts to be output.

If Normalized is selected then select the Normalize Units of measure in cubic feet (ft³), cubic meters (m³) or liters (L).

Once .PDF output formatting is configured, all .PDF files will have this formatting when exported to USB or CIFS.

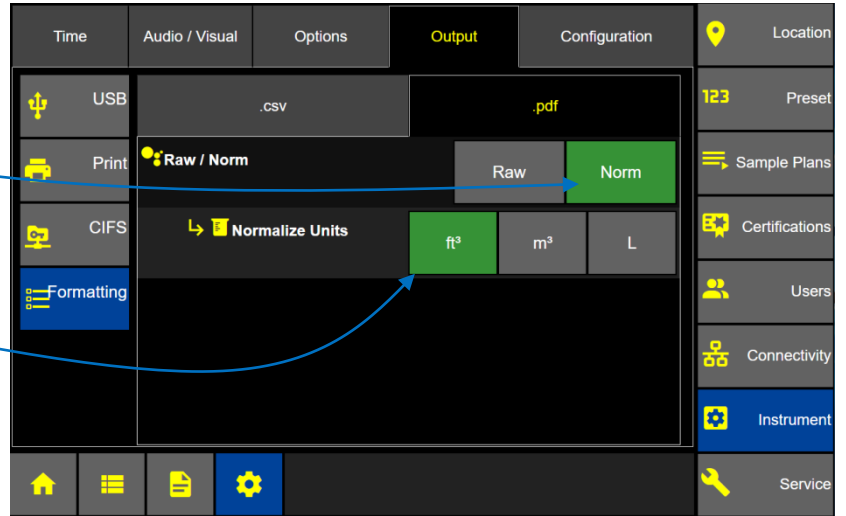

Configuration

All of the ApexZ settings are saved in the ApexZ configuration file and can be exported onto a USB key. The exported configuration file can then be loaded onto another ApexZ instrument or edited using our LMS XChange software.

Save ApexZ configuration file to USB key

Place a USB key in the ApexZ USB drive.
Press the Save button to display the Save Confirmation screen.

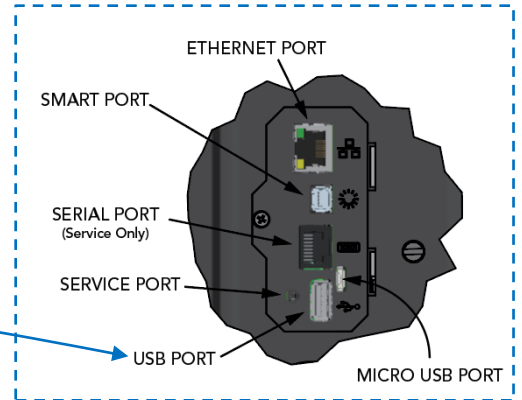

Instrument Options: Configuration

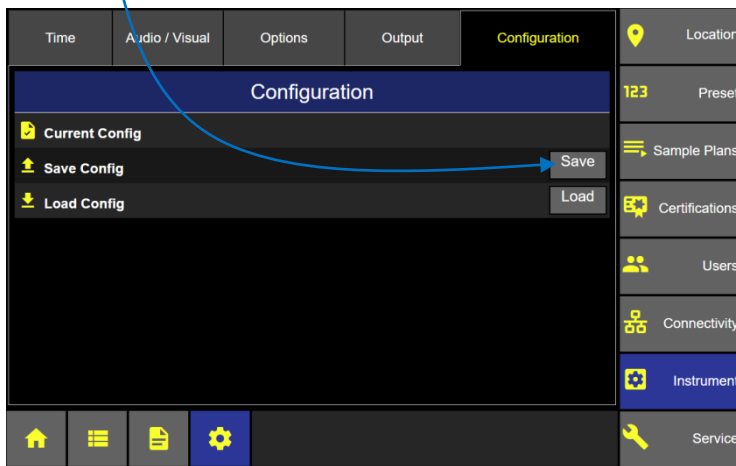

Press the green check mark button to confirm exporting the configuration to the USB key.

Or press the red x button to cancel.

Save Configuration File



Load ApexZ configuration file from a USB key

Place a USB key with the desired configuration file in the ApexZ USB drive and press the Load button.

The Select File screen will display next.

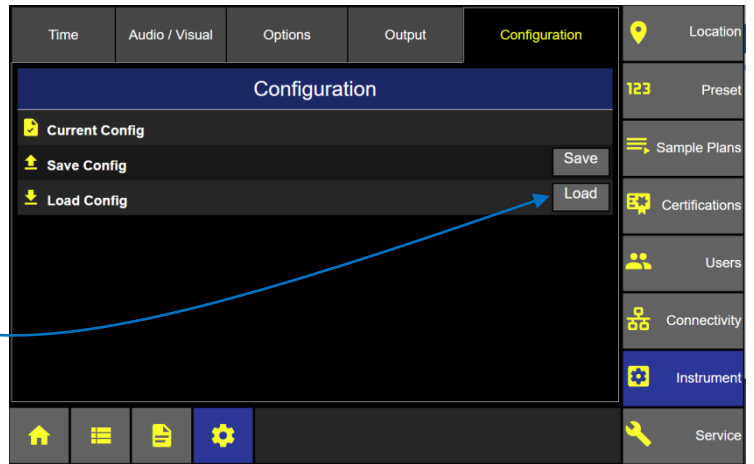

Select Configuration File to Load

Select your configuration file to load and it will highlight blue.

Press the Save button to load the selected configuration.

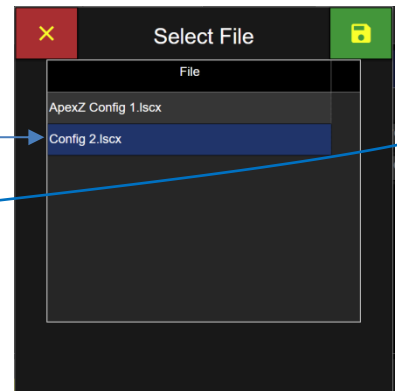

Press the green check button to import configuration.

Or press the red x button to cancel with no import.

Confirm to load configuration

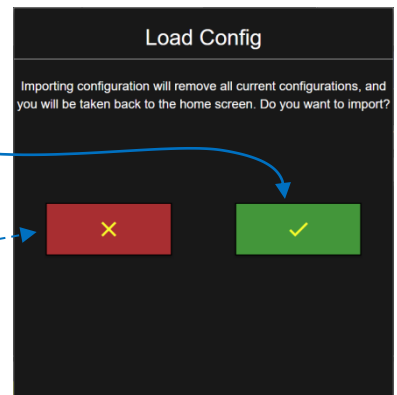

WARNING: Importing a configuration will remove the current configuration, and you will be taken back to the home screen.

Blank Page

Connectivity

From the Settings screen press the Connectivity button to view Ethernet, WiFi, AD/LDAP, CIFS and 3rd Party API settings.

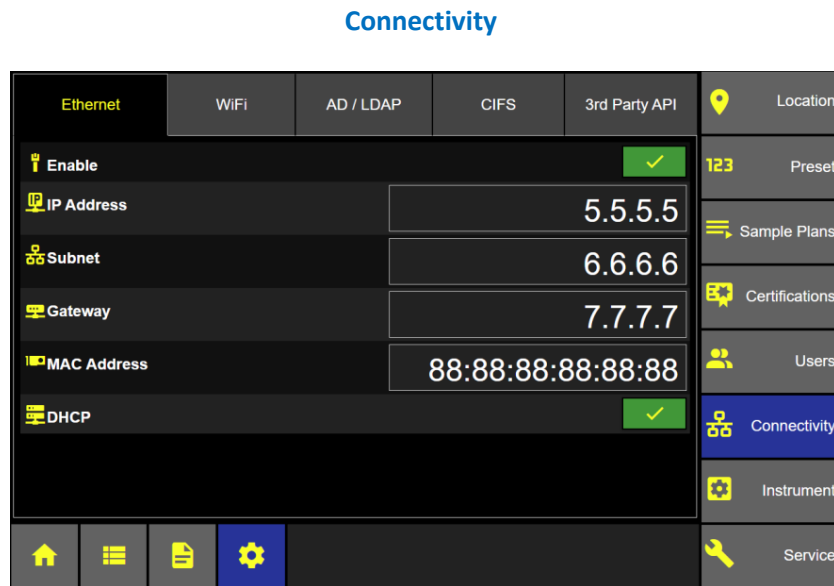

LMS XChange Software 2.x

The LMS XChange 2.x software was designed for use with ApexZ particle counters and is downloadable from the www.golighthouse.com website. LMS XChange 2.x allows users to import data collected on ApexZ3 and ApexZ50 portable particle counters and display the data in a table that the user can view and/or save to an Excel, .CSV or PDF file. Additionally, Administrator users can manage configurations for ApexZ instruments using LMS XChange. LMS XChange has the following main features:

- Import data manually from Lighthouse ApexZ3 and ApexZ50 particle counters.
- Import .lsdx (Lighthouse secure data transfer) files created by ApexZ3 and ApexZ50 instruments.
- Display the imported data in a table, allowing the user to also export the data to an Excel, .CSV or PDF file.
- Three levels of user accounts – Operators, Power Users, and Administrative users.
- LMS XChange Administrator users can create, edit, save and load ApexZ3 and ApexZ50 configurations.
- Record logins, updates, delete, import, configuration changes, etc. in the LMS XChange Audit Log.

Ethernet

Connectivity: Ethernet Enabled

When Ethernet is enabled, the IP Address, Subnet and Gateway will be locked out from editing.

Ethernet is enabled:

IP, Subnet, Gateway are LOCKED.

DHCP is enabled:

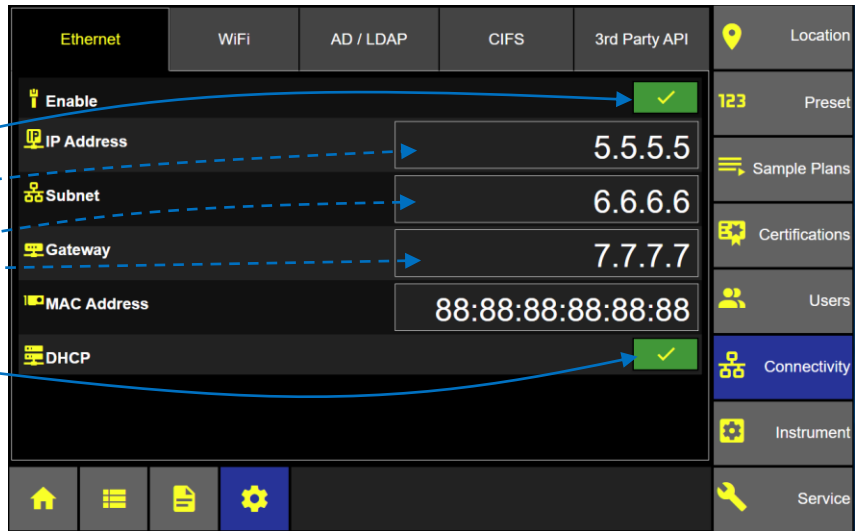

Connectivity: Ethernet Disabled

Ethernet Disabled

Disable the Ethernet and disable DHCP to allow editing of the IP Address, Subnet and Gateway.

Ethernet and DHCP disabled.

IP Address, Subnet, Gateway are open to edit.

DHCP is disabled.

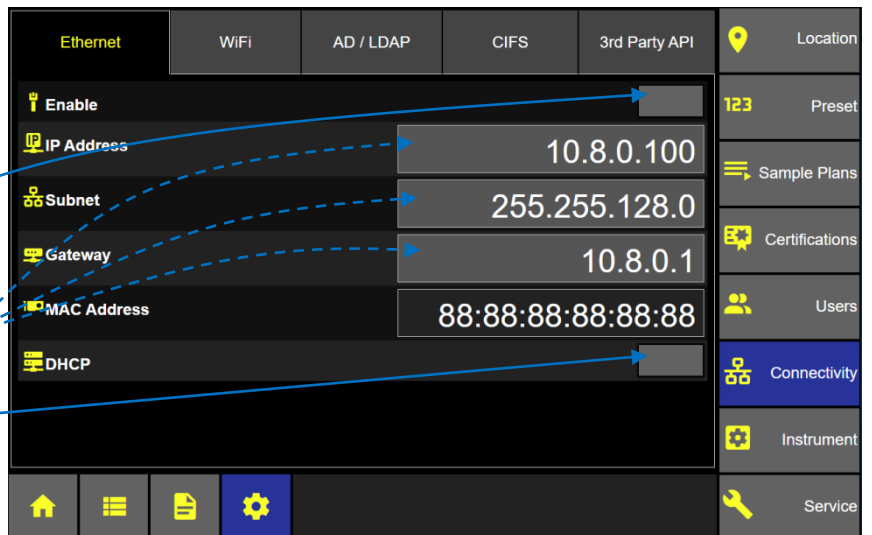

Connectivity: Ethernet

Edit Ethernet Address

Press the IP address, subnet or gateway input buttons to display the input key pad and edit these values.

Note: MAC Address is fixed and unique to the ApexZ instrument and cannot be changed.

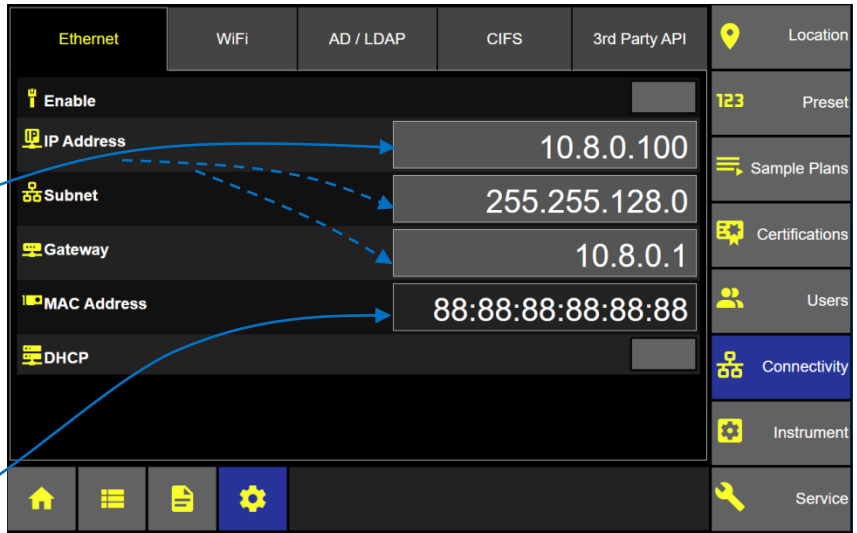

IP Address

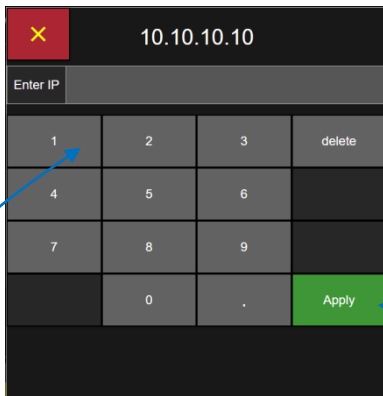

Subnet Address

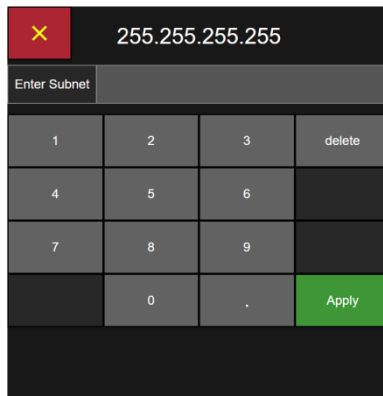

Gateway Address

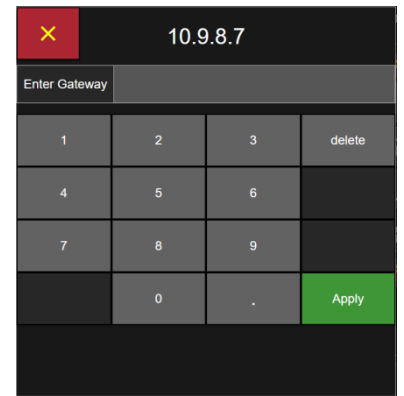

Enter the valid Address and press the Apply button.

When IP, Subnet and Gateway are entered then press the Enable button to enable the Ethernet connection

DHCP

(Dynamic Host Configuration Protocol)

When DHCP is enabled the IP Address, Subnet and Gateway will be dynamically assigned from the HOST network connection.

User editing will be locked.

To enable DHCP, disable the Ethernet connection first.

Connectivity: DHCP enabled

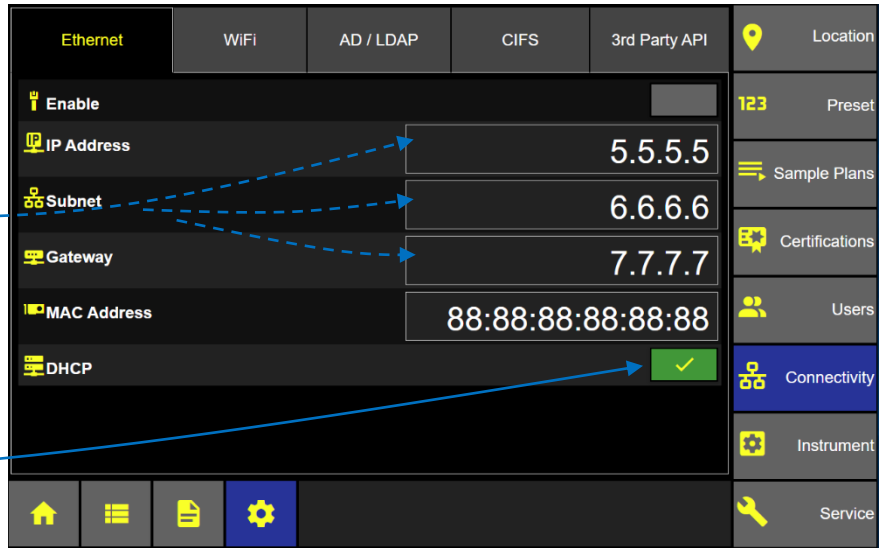

Connectivity: Ethernet with DHCP Enabled

After the DHCP has been enabled press the Enable Ethernet button to complete the DHCP connection.

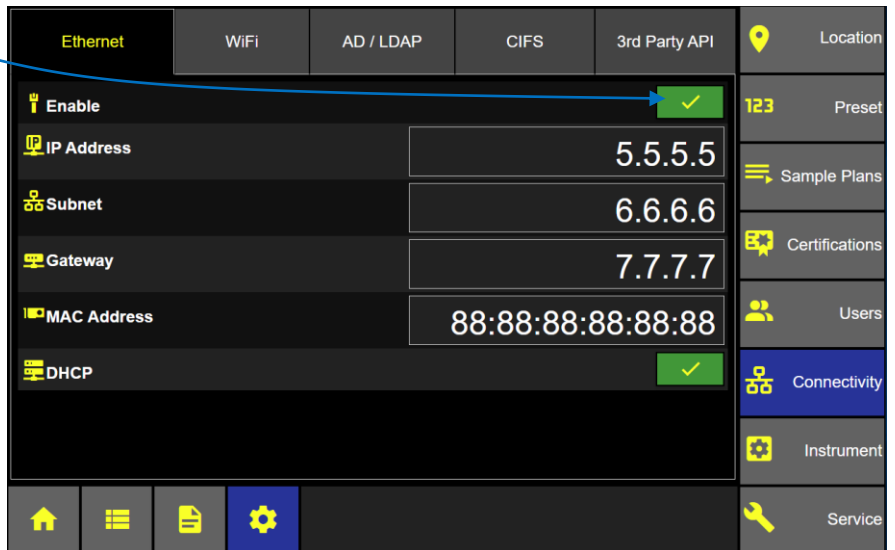

Connectivity: Wi-Fi Screen

Wi-Fi

Press the Wi-Fi Enable button to enable Wi-Fi.

Press the + button to Configure 1 to 5 Wi-Fi connections.

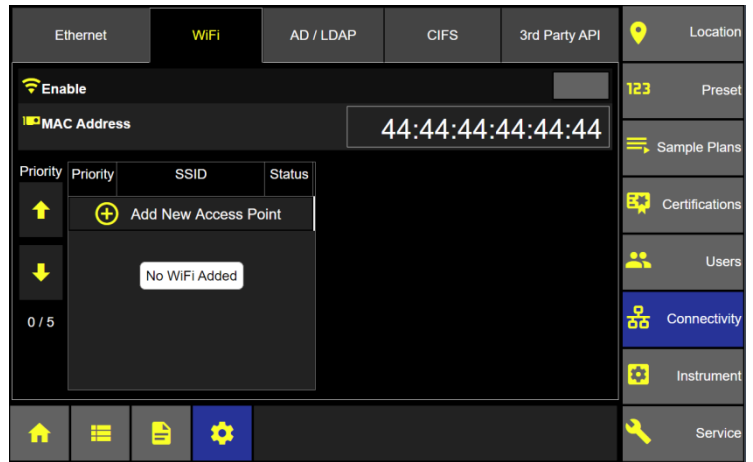

Press the Scan button to search for available Wi-Fi networks or routers in the area.



Scan for Wi-Fi

Press and select a Wi-Fi network for your ApexZ communication.

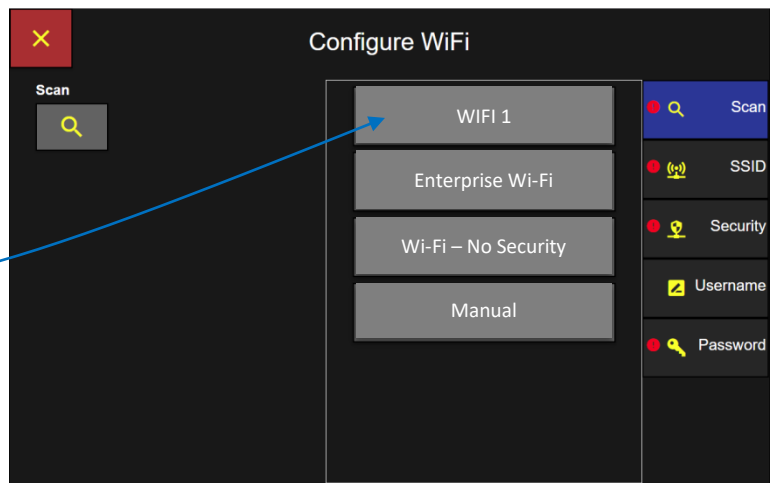

After a Wi-Fi has been selected ApexZ will mark with a red dot the remaining required tabs to complete the configuration.

Open Wi-Fi configurations:
Security will be preset to "None".

Local Network Wi-Fi:
Security will be preset to WPA-PSK.
Password input is required.

Enterprise Wi-Fi configurations:
Security will be preset to WPA-EAP.
Server Certificates are accepted but not required.
Username input is required.
Password input is required.

Manual Wi-Fi Configuration

Connectivity: Wi-Fi Scan Screen

Select Wi-Fi

Select Manual Wi-Fi Configuration



Press the SSID button.

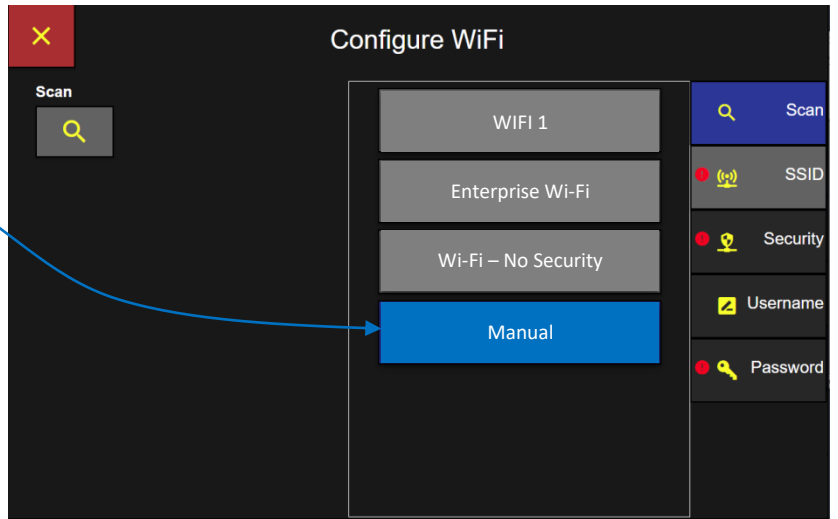
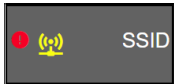

Connectivity: Wi-Fi SSID

Enter the SSID with the keypad

Press Apply

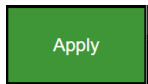

Press the Security button.

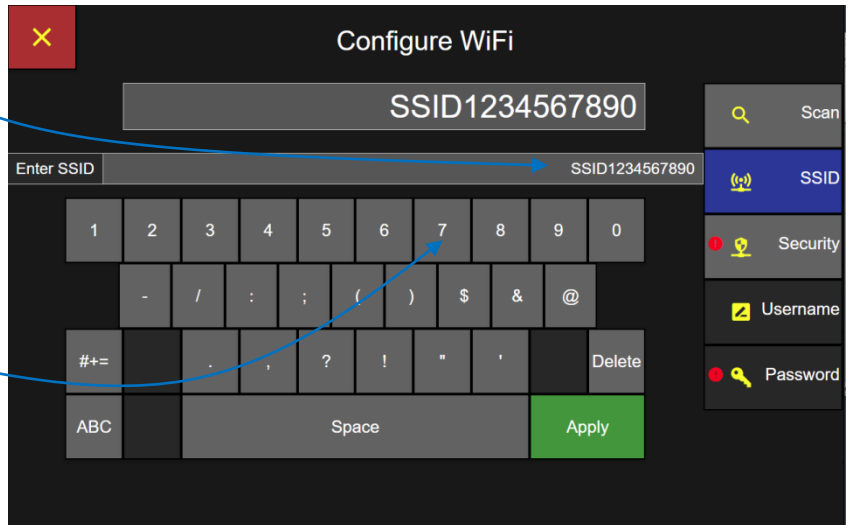
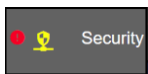

Select Wi-Fi Security

Select Security Type.

Security will be selectable only for Manual Wi-Fi configurations.

Security will be preselected according to the Wi-Fi type detected.

WPA-PSK

Wi-Fi Protected Access – Pre-Shared Key
Password required only.

WPA-EAP

Wi-Fi Protected Access – Enterprise
Certificate accepted, not required.
Username required.
Password required.

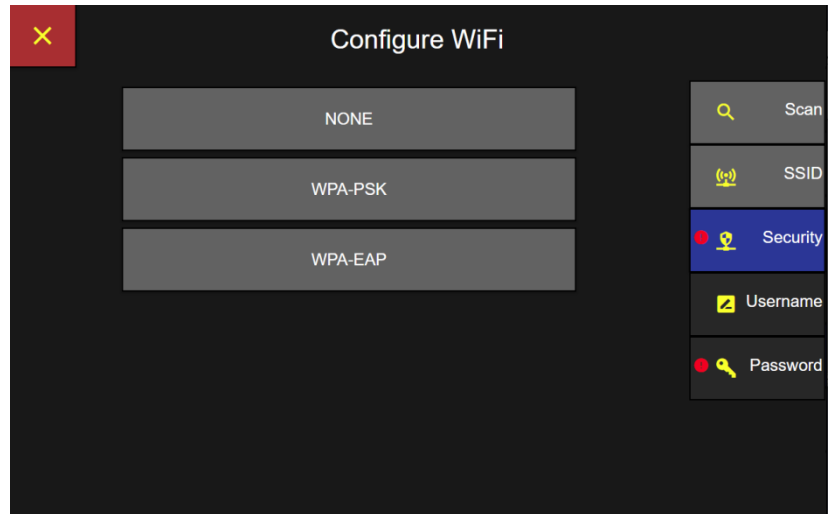
Connectivity: Wi-Fi Security

Enterprise Wi-Fi configurations:
Security will be preset to WPA-EAP.
Username input is required.
Password input is required.

Enter Username

Enter Username with the key pad.

Then press Apply.

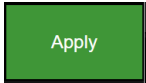

Press the Password Button.

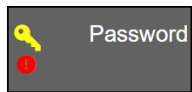

Connectivity: Wi-Fi Username

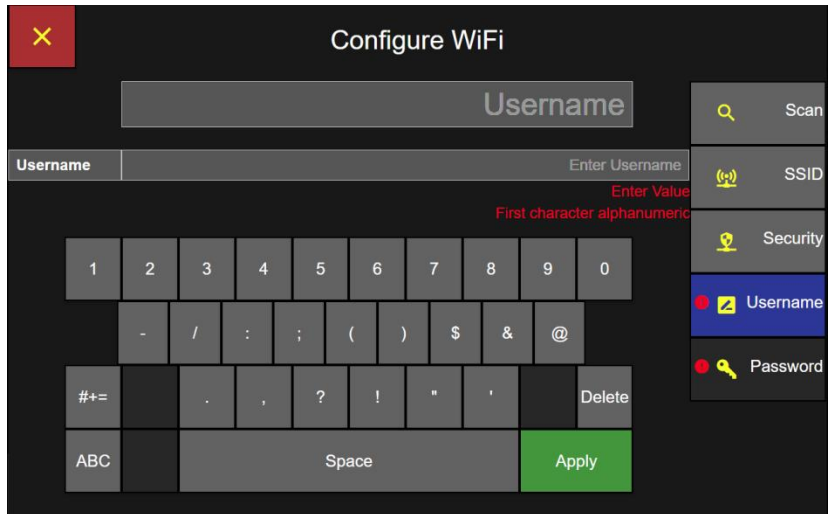

Enter Password

Enter password on the keyboard screen and press Apply.

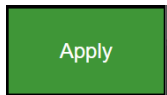

Press the Save button to save settings and connect to Wi-Fi selected.



Connectivity: Wi-Fi Password

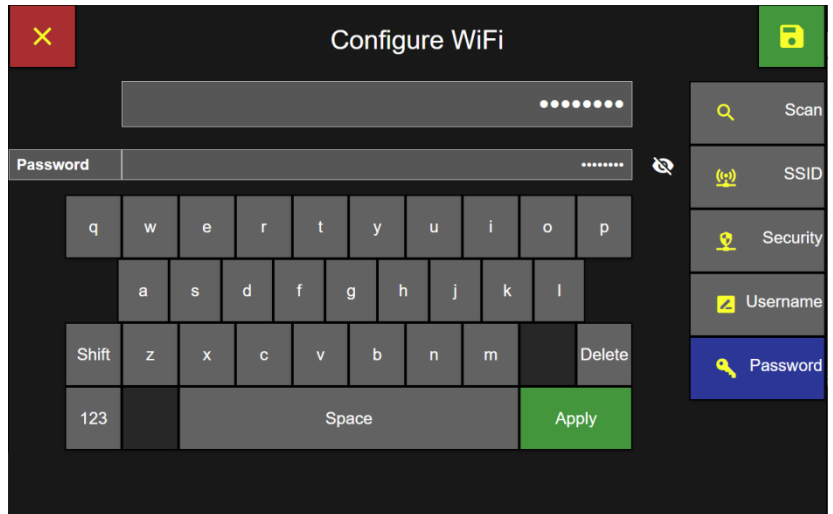

When the ApexZ successfully connects to the Wi-Fi network, a “Connection Successful” message will appear.

Active Directory AD/LDAP

Validate Users through your network Active Directory

ApexZ allows user login authentication to happen through your Active Directory network connection. User names and passwords logging into the ApexZ instrument will be verified against Active Directory usernames and passwords.

User Permission Levels can be assigned to AD Groups on your network. Users logging in from AD Groups will be given that AD Groups' assigned permission Level on the ApexZ instrument.

Contact your IT department to obtain the URL and Domain for your Active Directory.

Connectivity: Active Directory

Active Directory URL (optional)

Press the URL button and use the keypad to enter the Active Directory URL.

Note: If URL is entered, we only attempt to authenticate to the Active Directory server at that IP.

Active Directory Domain (required)

Press the Domain button and use the keypad to enter the Domain name.

Note: If Domain is entered and IP is left blank, then we will pull all valid IP addresses of the domain and attempt to validate credentials until one succeeds.

Secure

Press and enable the Secure button to use LDAP over SSL protocol.

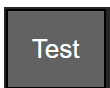
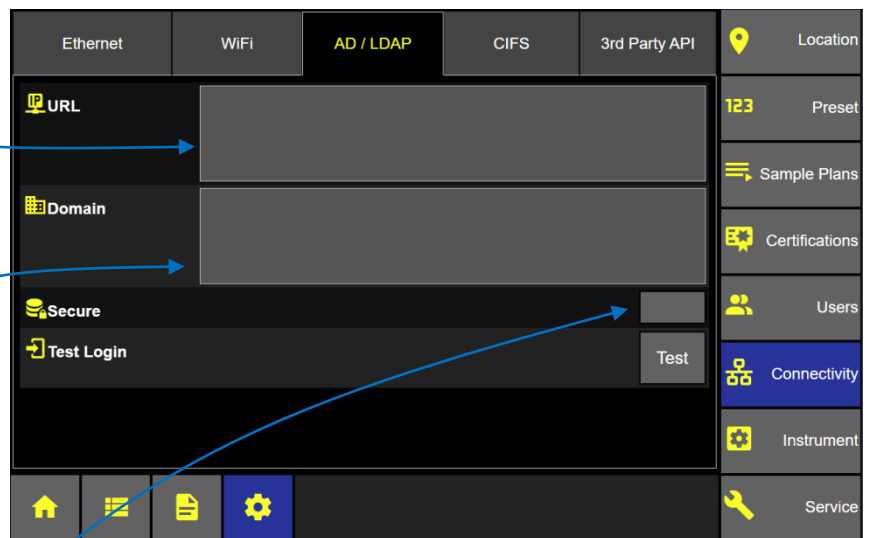

Press the Test button to test login to the Active Directory.

Note: Active Directory URL and Domain must be set up and a Test Login performed before logging in with AD user accounts.

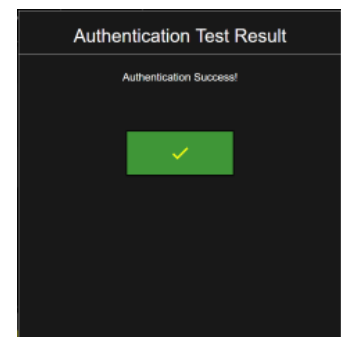

To activate AD Groups go to:

1. Settings
2. Instrument
3. Options
4. User
5. AD Groups



CIFS -Common Internet File System

The CIFS “Common Internet File System” is used to connect and export data to shared network drives.

Contact your IT Department for the URL, Path and Folder settings for your CIFS.

CIFS URL

Press the URL button and enter the IP address using the keypad.

Then press the green apply button.

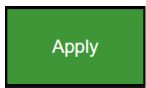

Connectivity: CIFS

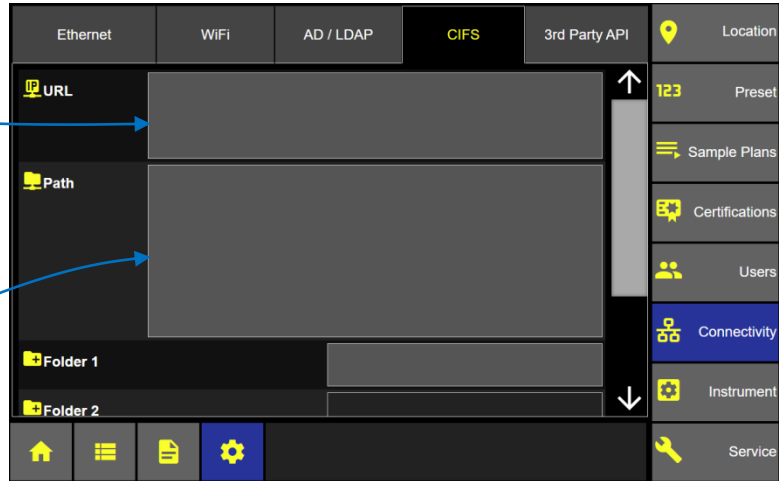

Path

Press the Path button and enter the CIFS Path using the keypad.

Then press the green apply button.

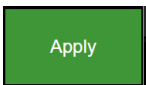

Connectivity: CIFS url

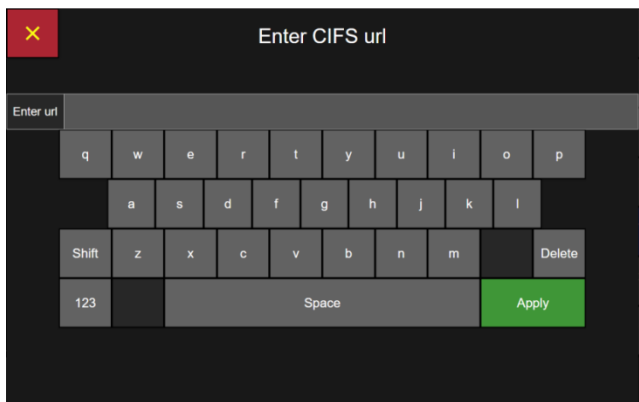

Connectivity: CIFS path

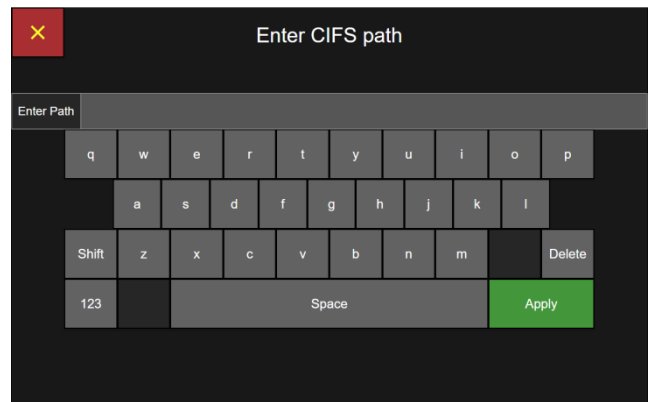

Folders 1-2-3

Folder 1, Folder 2, and Folder 3 are designed to allow the user to organize data into sub-folders according to the instruments they were downloaded from.

Press each Folder button and select the desired sub folder name from the pop up list:

Serial #
Date
Model
None

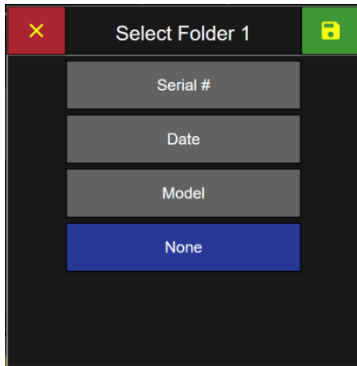

Connectivity: CIFS Folders

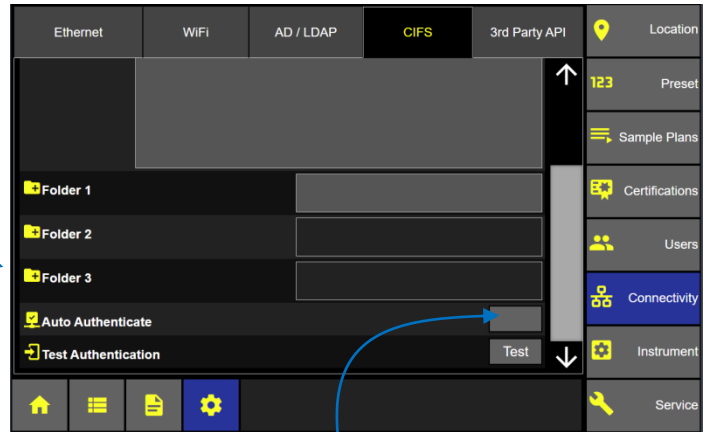

Auto Authenticate

Press the enable Auto Authenticate button and ApexZ will use the current logged in user's credentials to authenticate with the network drive when exporting data. Disable Auto Authenticate will require every user to enter their username and password prior to exporting data to the network drive.

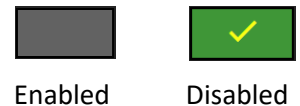

Test Authentication

Press the Test button to test Authentication.

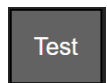

3rd Party API - Application Programming Interface

Port Number

Press the Port button to enter a port number with a minimum of 4000 and a maximum of 8000.

Connectivity: API Port Number

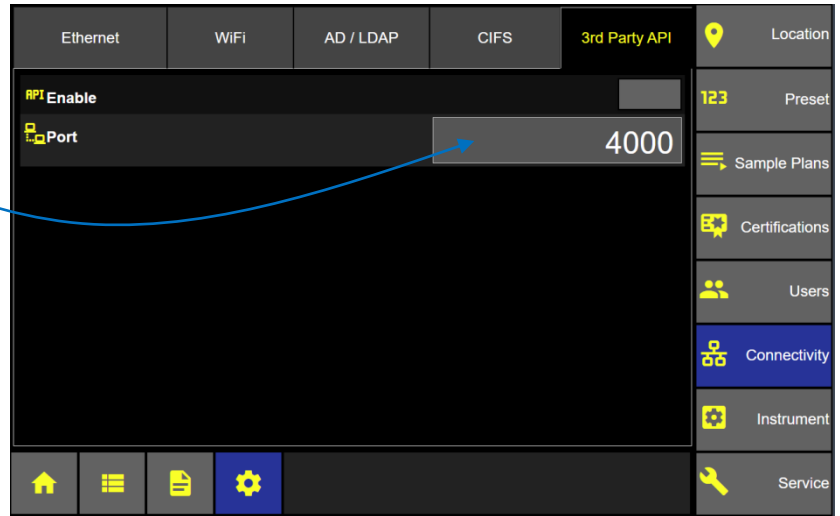

Connectivity: Enable 3rd Party API

Enable API

After selecting the port number then press the Enable API button.

After the API has been enabled the port number may not be modified. To change the port number you must disable the API enable button first to allow editing of the port number.

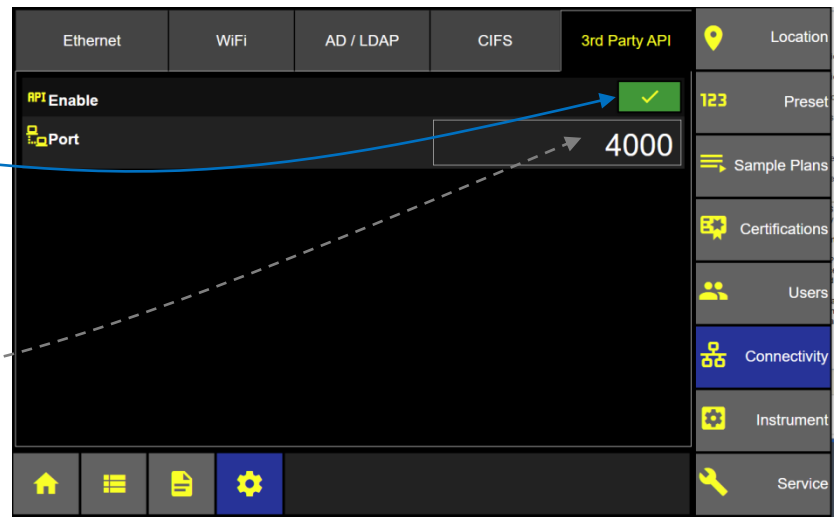

Blank Page

Locations and Groups

The ApexZ instrument has the capacity to store up to 2500 location names. The first 250 location names have been named as “Location 0001”, “Location 0002” and up to “Location 0250”. Additional Location names can be added and the location name will default to the next sequential location # for example “Location 0251”. Location names can be easily edited/renamed or deleted.

Groups may also be created and locations may be assigned to Group names. Up to 250 Groups can be created and locations can be assigned to these groups.

View Locations

From the Home Screen press the Settings button to display the Settings screen.

From the Settings screen press the Location button and it will highlight blue and display the Locations and Groups Screen

Home Screen

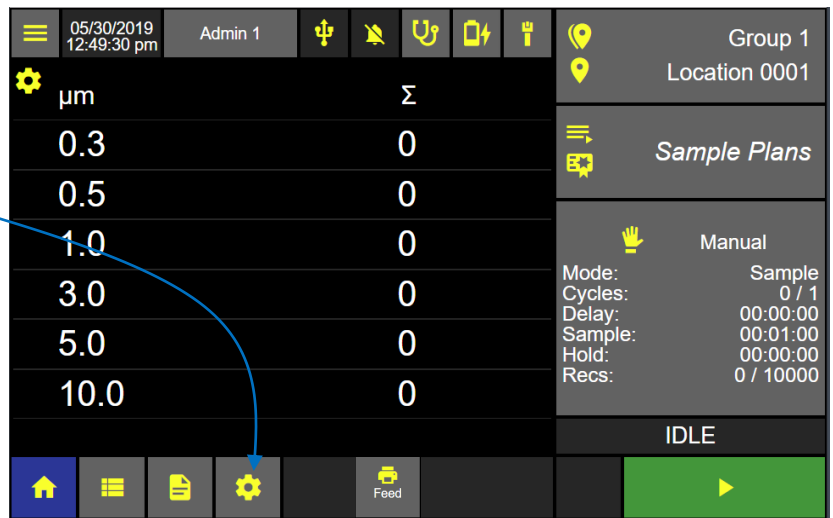

Configuration: Locations and Groups Screen

Scroll to view all Locations.

ApexZ is shipped with 250 named locations “Location 0001, Location 0002, ...”. These location names can be renamed or deleted and additional locations can be created up to 2500 total location names.

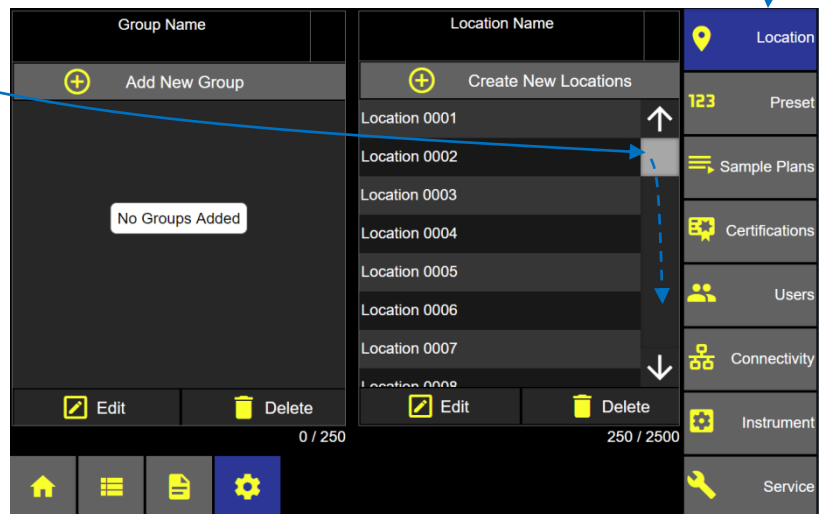

Create New Locations

Configuration: Locations and Groups Screen

Press the + button to Create a New Location.

After pressing the + button the next location number will be created and named "Location 0251".

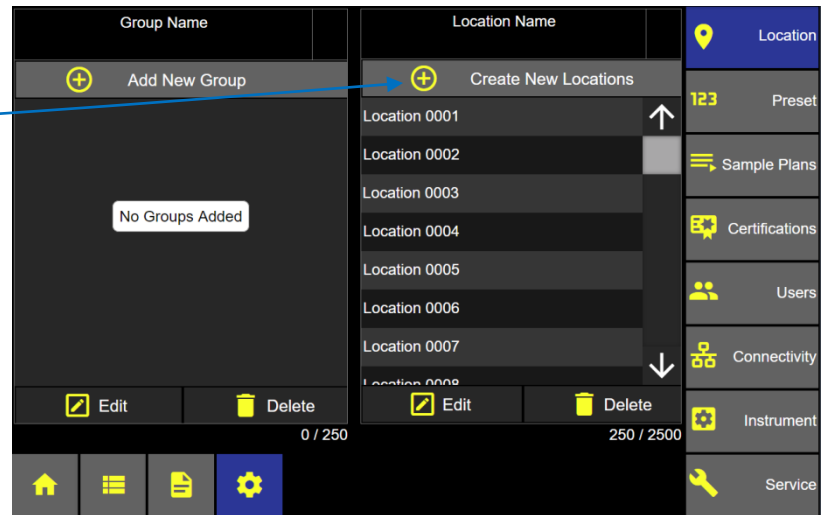

Add additional locations before saving

Press the + button to add one more location to the list of new locations.

Each new location will be named sequentially "Location 0251, Location 0252, Location 0253... etc."

Press the - Delete button to delete a highlighted location from the list.

Press the Edit button to change the name of the location.

Press the green Save button to add the list of new locations to the ApexZ database.

Add Locations Screen

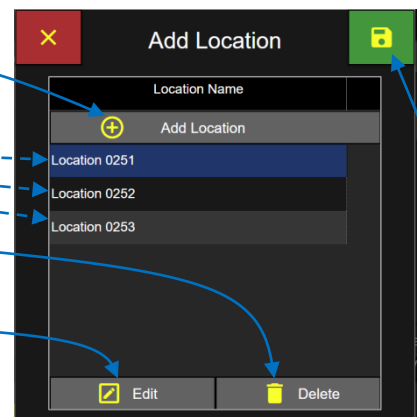

Edit a Location

Locations Screen

Select a location name and it will highlight in blue indicating that it has been selected.

Press the Edit button to edit the selected location name or to assign the location to a Preset.

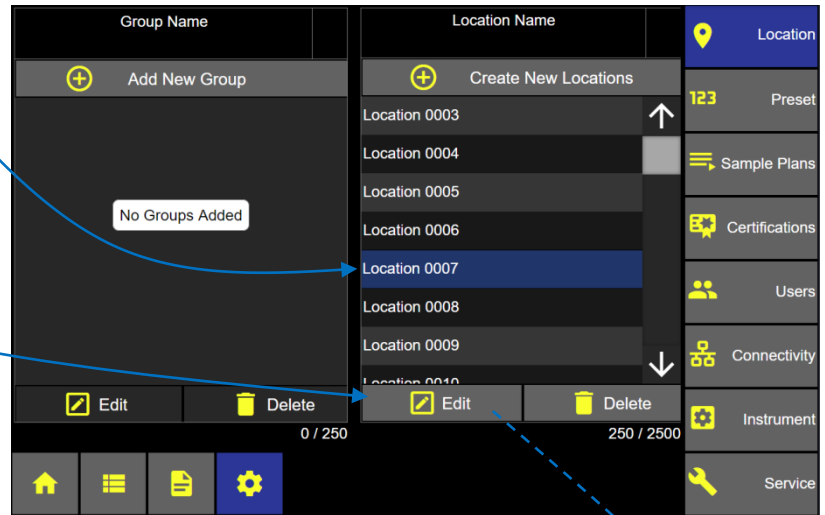

Edit Location Name

Delete and overtype a new location name and then press the green Apply button.

Edit Location Preset

Press the Preset button to display the assign Preset to Location screen.

Select the desired preset to apply to this location. The selected Preset will display in the Assigned Preset box. Note that a preset setting may be assigned to multiple locations but a single location may only have one Preset assigned to it.

Press the green Save button to save the location edits.

Edit Location Name Screen



Assign Preset to Location Screen

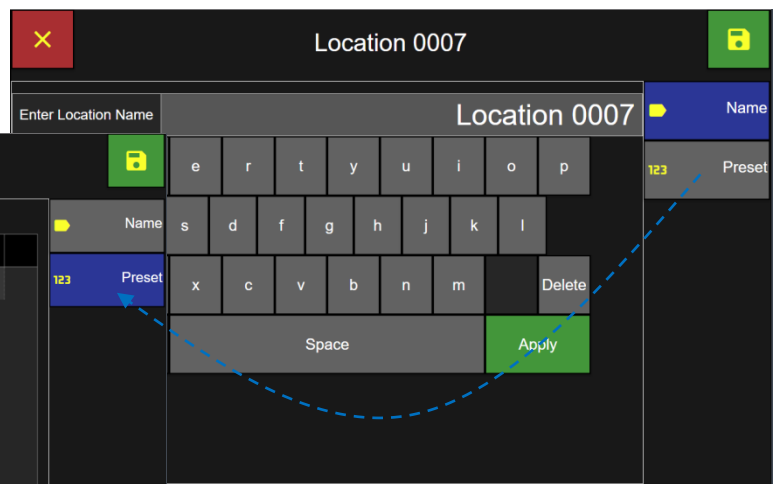
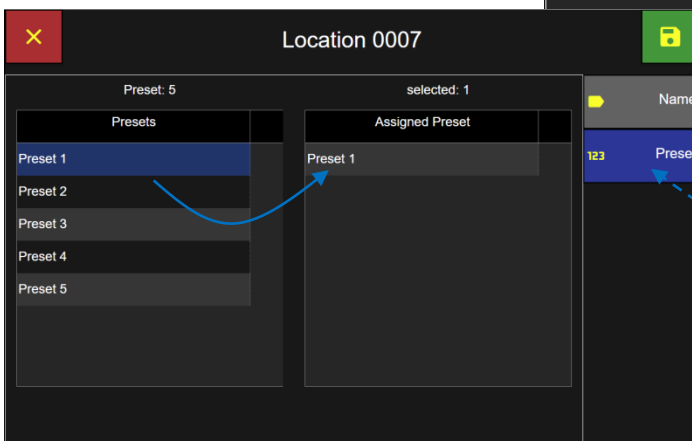

Delete a Location

Select a location and it will highlight in blue indicating it has been selected.

Press the Delete button to delete the selected location.

Press the green check box to confirm deleting the location from the ApexZ database.

Or press the red x box to cancel.

Locations Screen

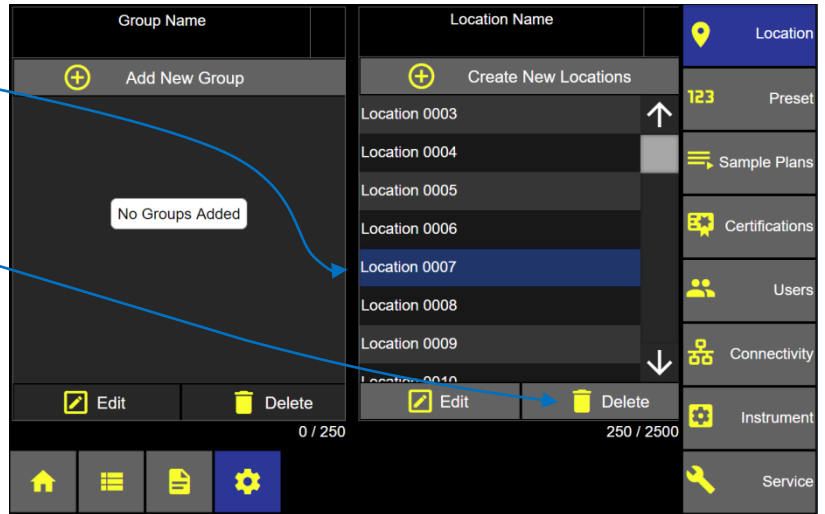

Confirm Location Delete

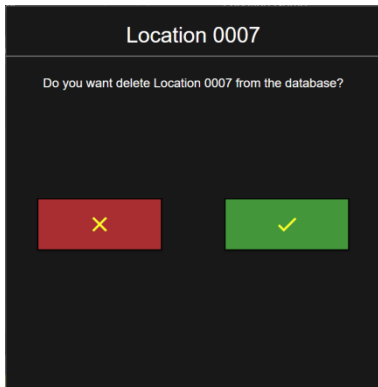

Add a New Group

Groups may be created and locations may be assigned to groups. Multiple locations may be assigned to a group but a single location may only be assigned to one group. Group names can be customized.

Groups and Locations

Press the **+** Add New Group button to add a new group.

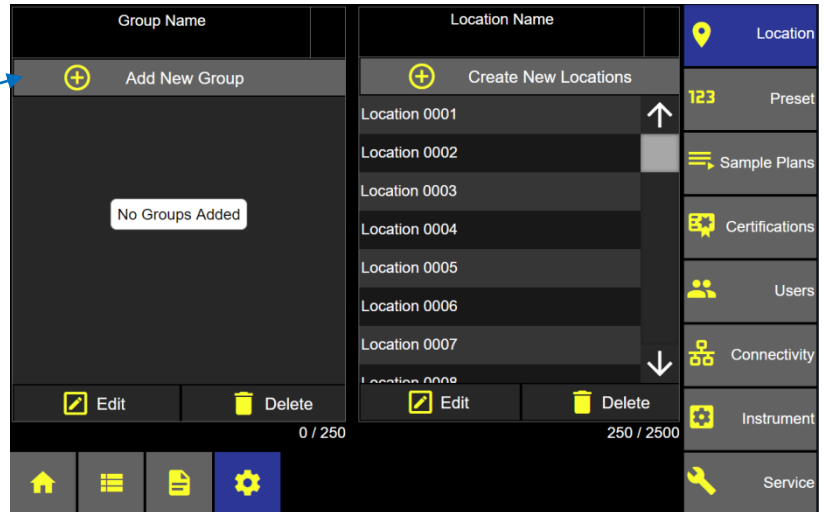

Adding a New Group

The New Group screen displays a list of all locations available to be assigned to the new group.

Total locations available.

Total locations selected.

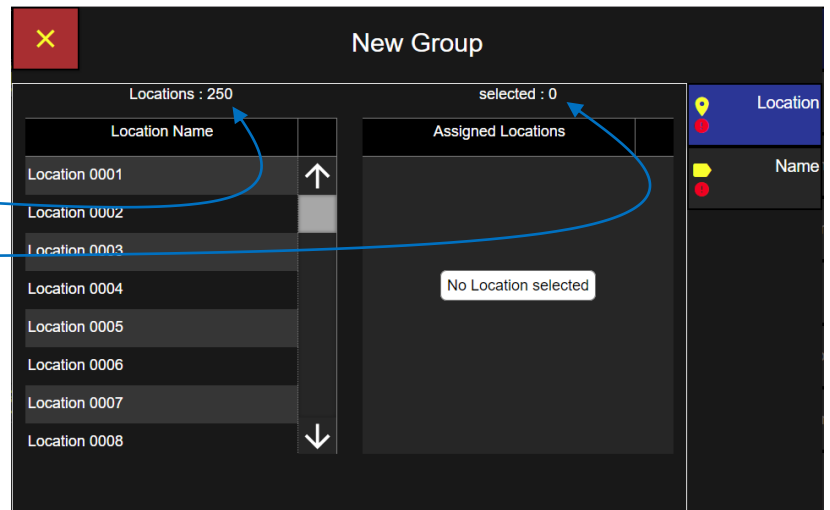

Note: ApexZ can store up to 250 group names. At least 1 Location must be assigned to a Group and each location may only be assigned to 1 group.

Assign Locations to a new Group

Select each location to be included in the group. Selected locations will highlight blue indicating they have been assigned to the new group and they will display on the Assigned Locations list to the right.

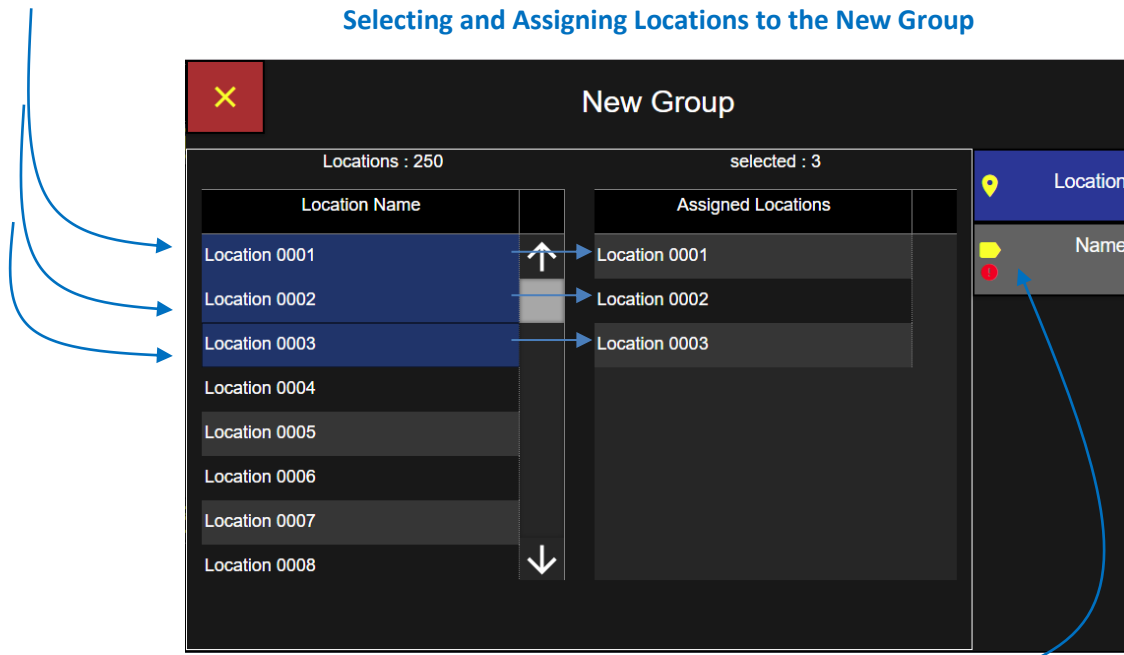

Select the Name button to display the Enter Group Name screen.

Group Name

Group Name Screen

Use the keypad to enter the Group name.

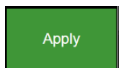

Press the green Apply button to apply the Group name.



Press the green Save button to save and return to the Location/Group List. The green save button only appears after a name has been entered and the Apply button has been pressed.

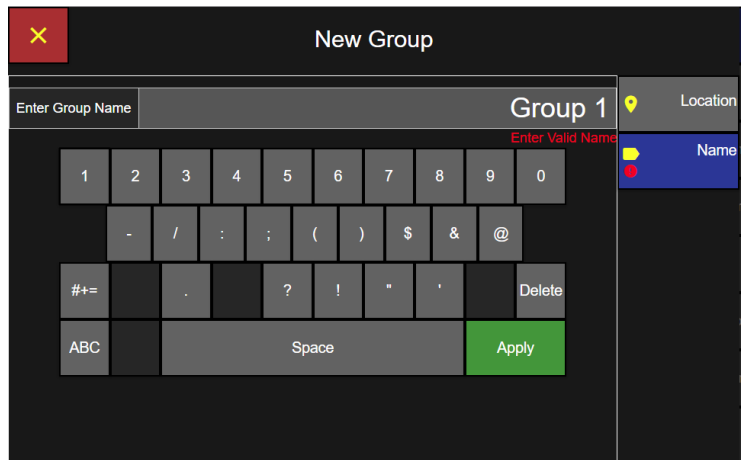

Group Selected – Assigned Locations Displayed

Group Selected

When a Group name is selected it will highlight blue and the locations assigned to that group will be displayed in the Location Name list.

The Add Available Locations button will be available to add more locations to the Group.

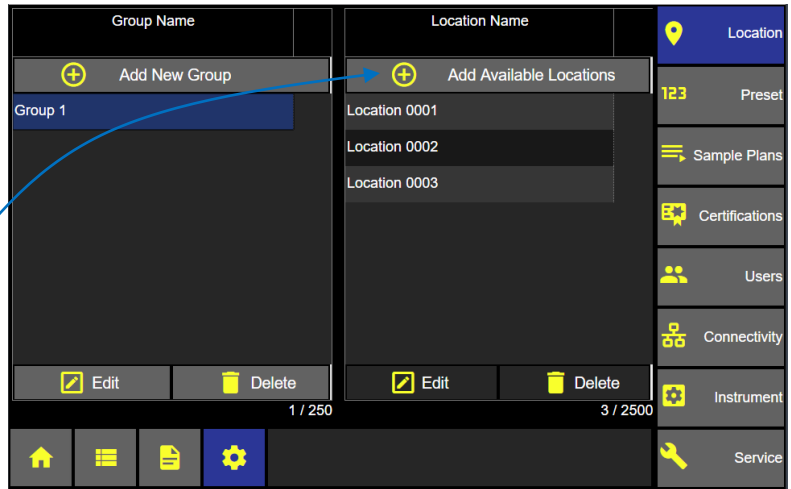

No Group Selected – All Locations Displayed

No Group Selected

When No Group name is selected then all Locations will be displayed and available to Edit or Delete.

The “Add Available Locations” button will change to a “Create New Locations” button and allow the user to create new locations in addition to Edit or Delete locations.

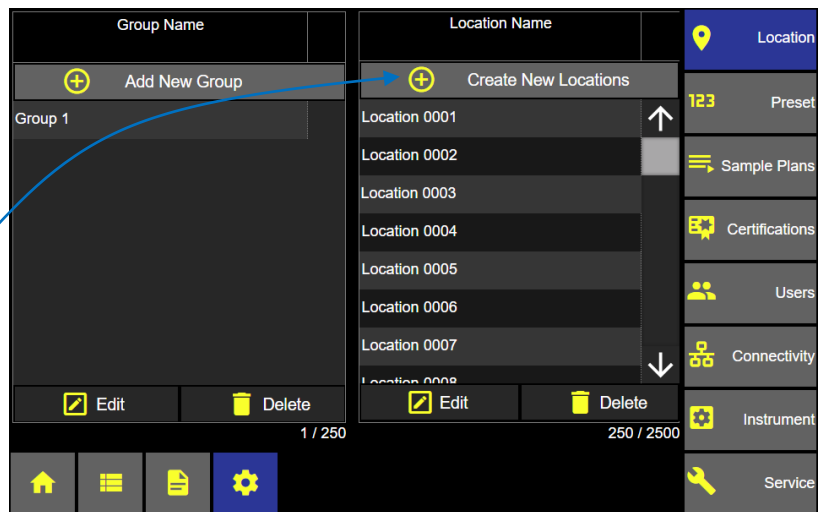

Edit a Group

Select a Group name and it will highlight blue and display all assigned locations.

Press the Edit button below the group name list and the Edit Group screen will display.

Locations and Groups Screen

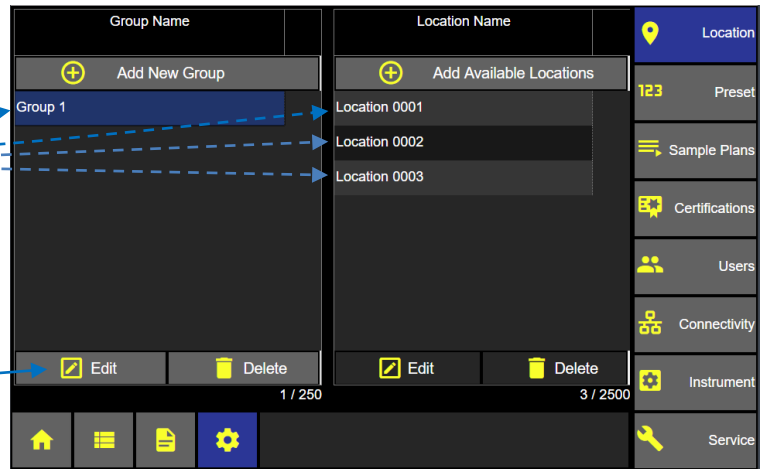

Edit Group Locations

Select additional locations to add to the Group or select locations to remove. Selected location names appear highlighted in blue.

Highlighted location names appear included in the Assigned Locations list for this group.

Remove a location from the group by deselecting the highlighted location from the location name list and it will be removed from the Assigned Locations list for this group.

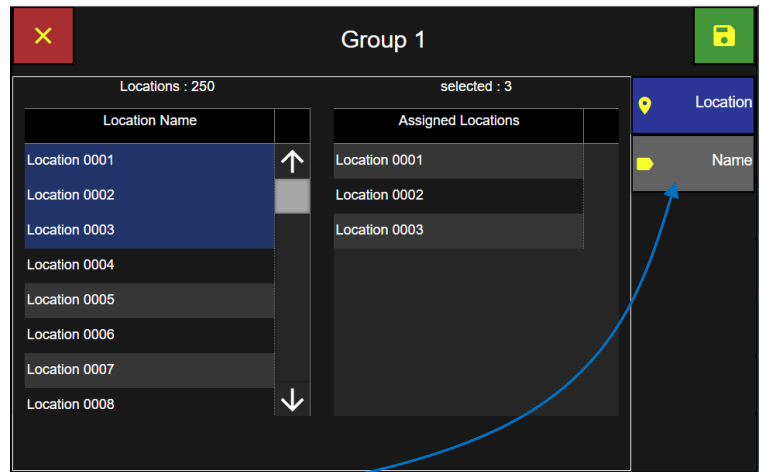

Select the Name tab and edit the Group Name.

Edit Group Name

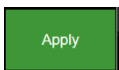

Edit the Group name with the keypad and press the Apply button.



Press the green save button to save the edit.

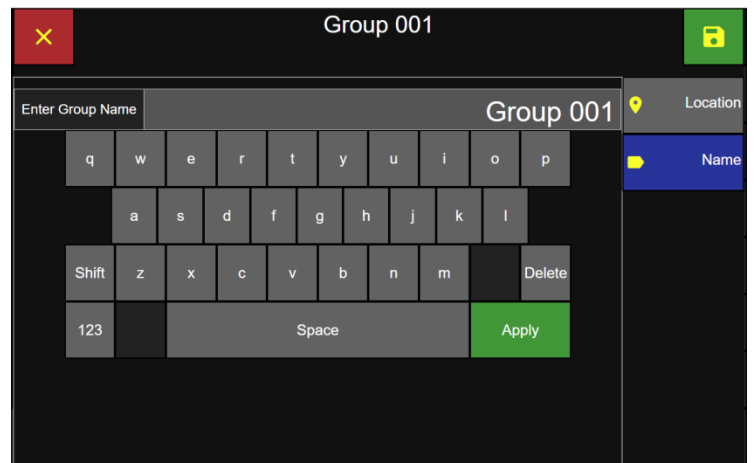

Delete a Group

Locations and Groups Screen

Select a group name and it will highlight blue and display any and all assigned locations.

Press the Delete button below the group name list and a delete confirmation pop up window will appear.

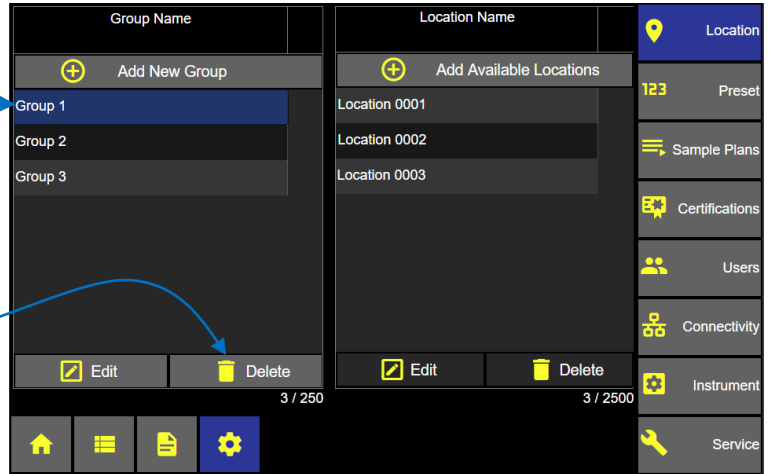

Delete Group Name Confirmation

Press the green check button to delete the selected group.

Or press the red x button to cancel and no delete.

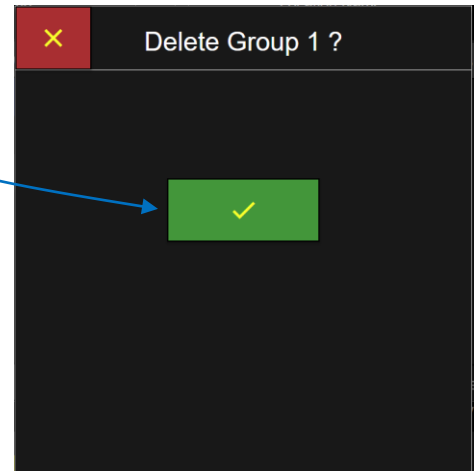

Blank Page

Presets

Sample setting parameters can be saved and named as Presets. Presets can then be assigned to locations. Locations linked to Presets will be bound by the sample parameters saved in the Preset. Up to 500 Presets can be added, edited or deleted.

Add a Preset

From the Home screen press the Settings button.

From the Settings screen press the Preset button.

From the Preset screen press the Add New Preset button.

Preset Screen

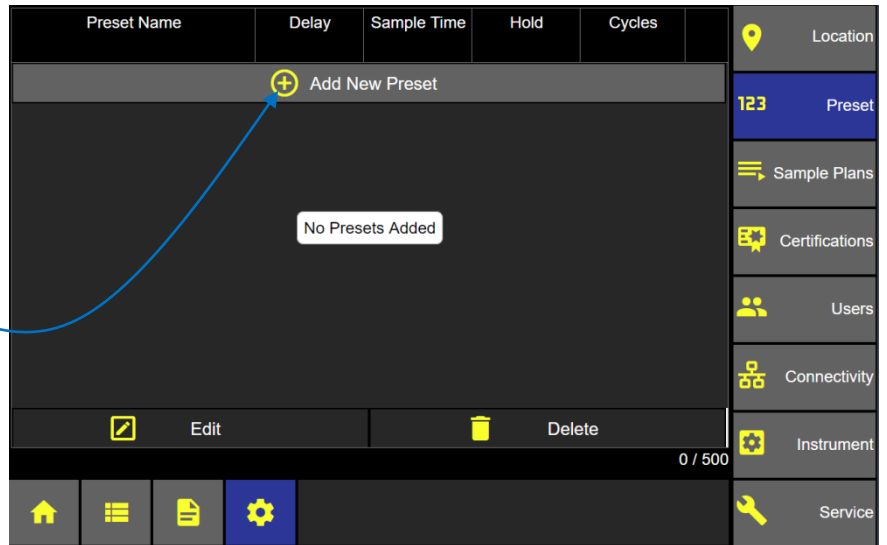

Preset Sample Settings

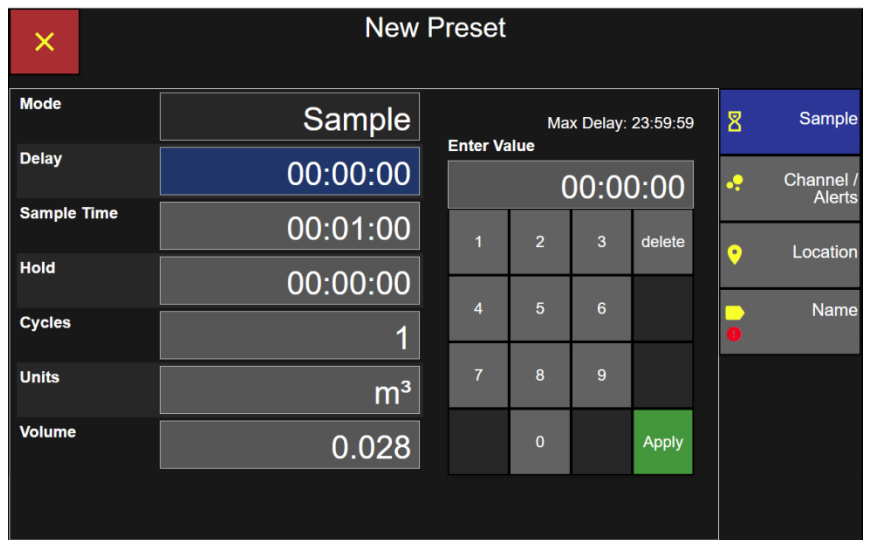

Enter Preset Sample Settings.

Delay Time

Select the Delay button and enter the delay time using the keypad and press the green Apply button.

Sample Time

Select the Sample Time button and enter the sample time using the keypad and press the green Apply button.

Hold Time

Select the Hold button and enter the hold time using the keypad and press the green Apply button.

Cycles

Select the Cycles button and enter the number of Cycles using the keypad and press the green Apply button.

Units

Select the Units button and select the units ft³ (cubic feet), m³ (cubic meters) or L (liters).

Volume

Select the Volume button and enter the sample volume with the keypad and press the green Apply button. Note that changing the sample volume will adjust the sample time accordingly. Vice versa changing the Sample time will change the sample volume accordingly.

Press the Channel/Alerts button to enable channels, warnings and alarms.

Preset Sample Settings

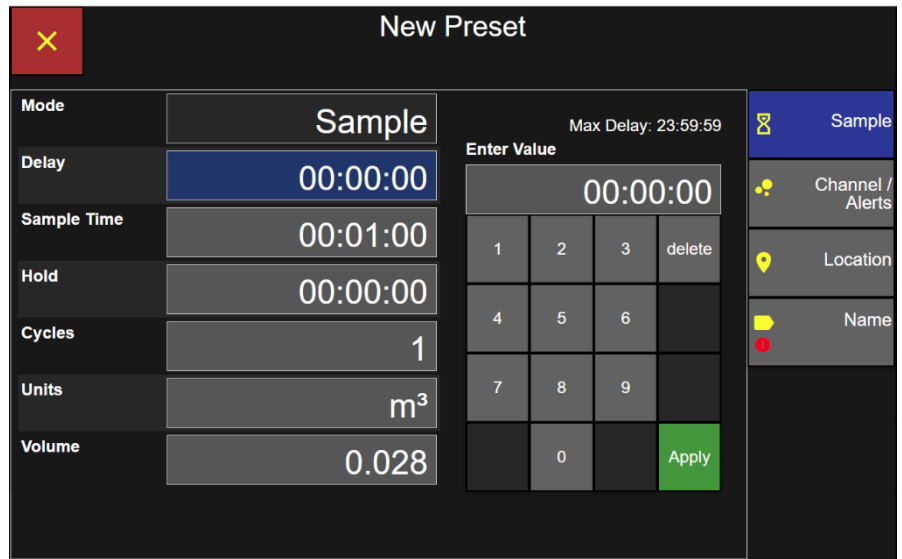

Edit Channel

Disable a Channel

Press one of the green colored channel size buttons to disable that channel and that channel will turn grey color and strike-out the channel size. This channel will not be included in this preset sample setting.

Note if Global Channels are enabled then channel settings may not be edited.

Preset Channel/Alerts Screen

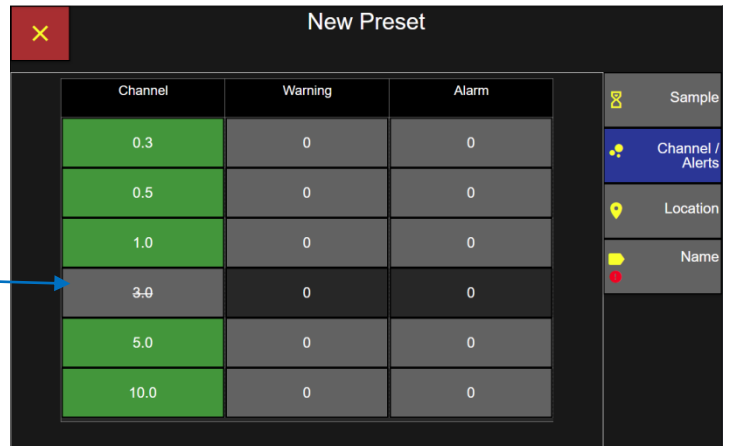

Preset Warning and Alarm settings

Enter Warning and Alarm settings

Press a warning button for any channel size and it will display the Enter Warning Screen.

Press an alarm button for any channel size and it will display the Enable and Enter Alarm Screen.

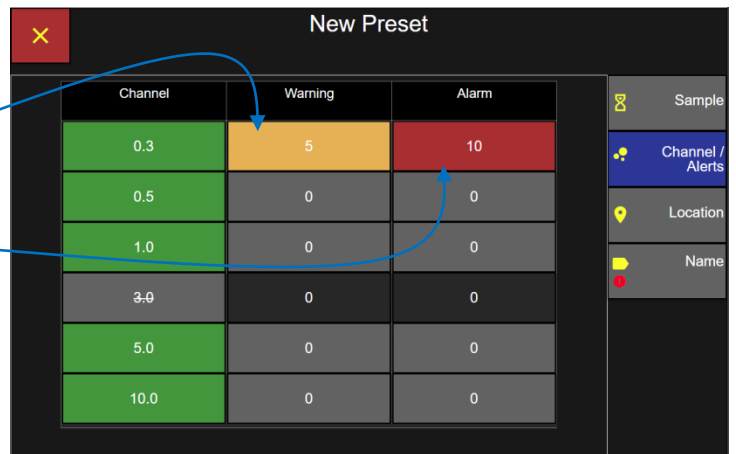

Enable & Enter Warning

Press the Enable button and it will highlight blue indicating the Warning or Alarm have been enabled.

Enter a particle count value with the keypad and press the green Apply button to save that warning or alarm level to this Preset.

The preset warning button will display orange. Alarm preset buttons will display red when enabled.

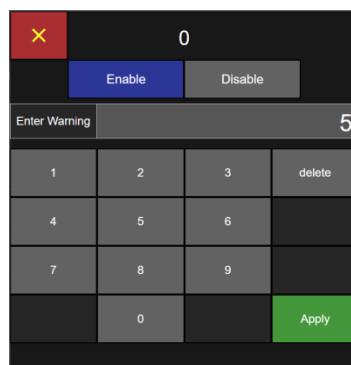

Enable & Enter Alarm

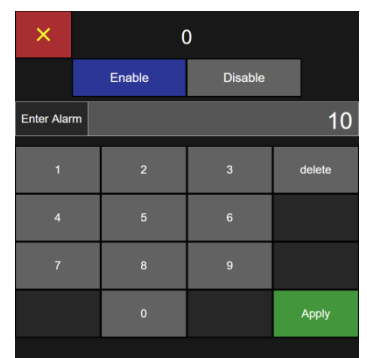

Assign Locations to the New Preset

A preset can be assigned to multiple locations.

Select location

Select location name(s) from the Location Name list and they will highlight blue and display on the Assigned Locations list.

Multiple locations may be selected and assigned to the same preset at the same time.

To remove a location from the assigned locations list press the location name again and it will un-highlight and be removed from the assigned locations for that Preset.

Assign Locations to New Preset

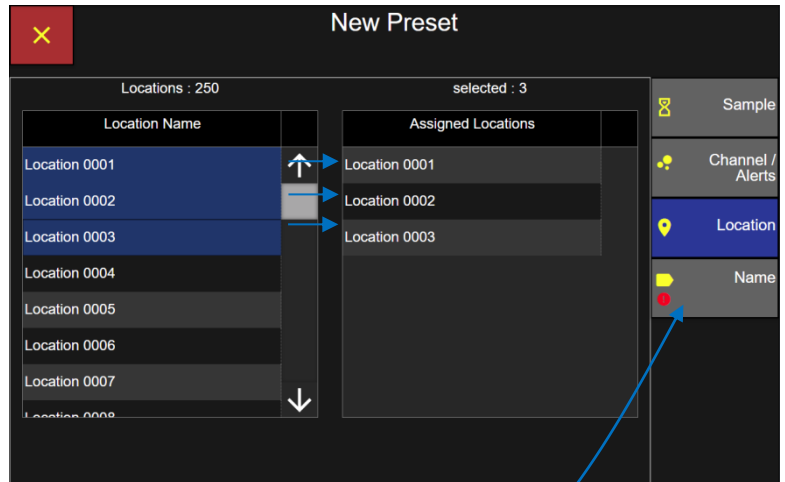

Press the Name button to display the Preset Name Screen.

Preset Name

Use the keypad to enter the preset name.

Preset Name Screen

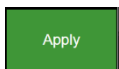

Press the green Apply button.

You can press any one of the Sample, Channel/Alerts, Location or Name buttons and review any of your Preset settings.

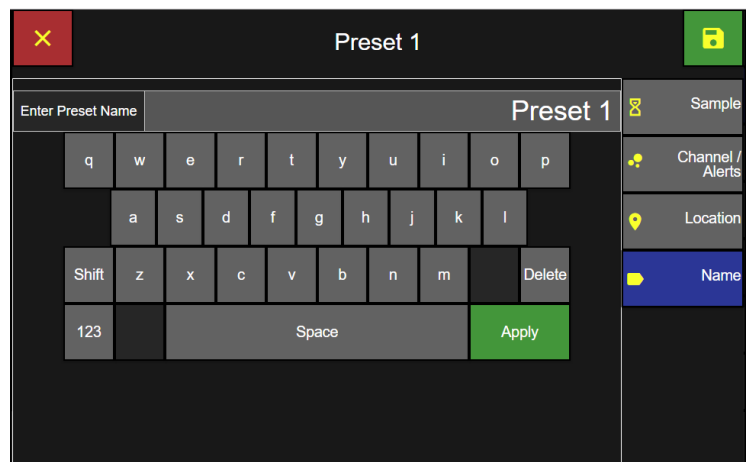

Press the green Save button to save the Preset.

Locations linked to Presets

When a preset has been assigned to a location then a linked icon will appear before the location name on the Home screen. The link icon indicates the location is linked to a Preset sample setting.

The preset sample setting will be displayed and locked below.

Home Screen

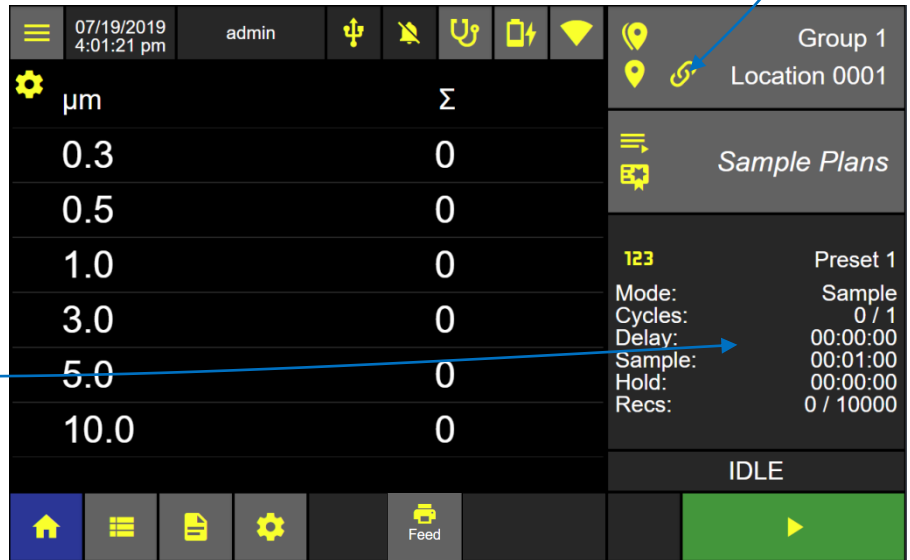

Linked Icon

Presets assigned to locations will display the linked icon on the Groups and Locations configuration screen.

Groups and Locations Screen

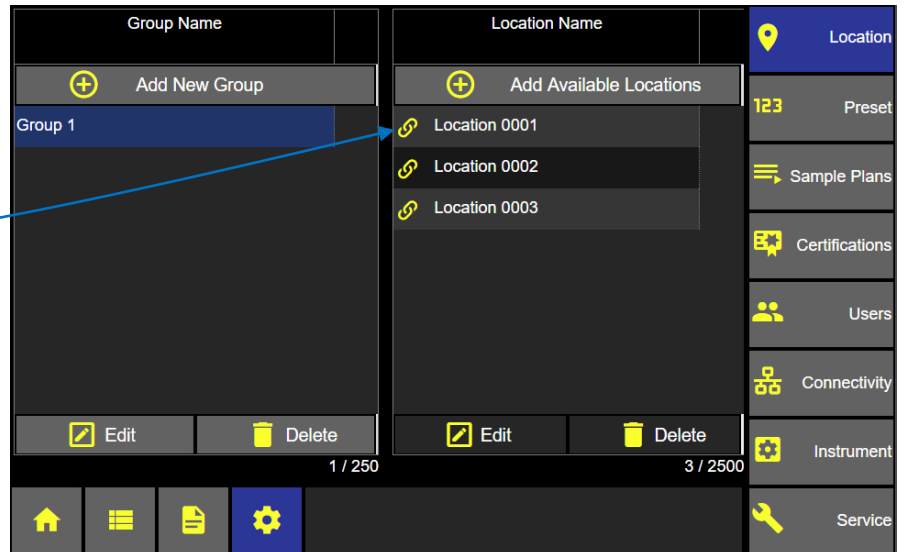

Blank Page

Sample Plans

Sample Plans are a collection of Locations with custom sample settings assigned to each location. Recipes (supported in previous versions of ApexZ instruments) were a collection of locations with the same sample settings used at each location. Sample Plans can act as Recipes did, but they can also, in addition, assign different sample settings to each location, either via a Preset or manually.

Home Screen

From the Home screen press the Settings button to display the Settings Screen.

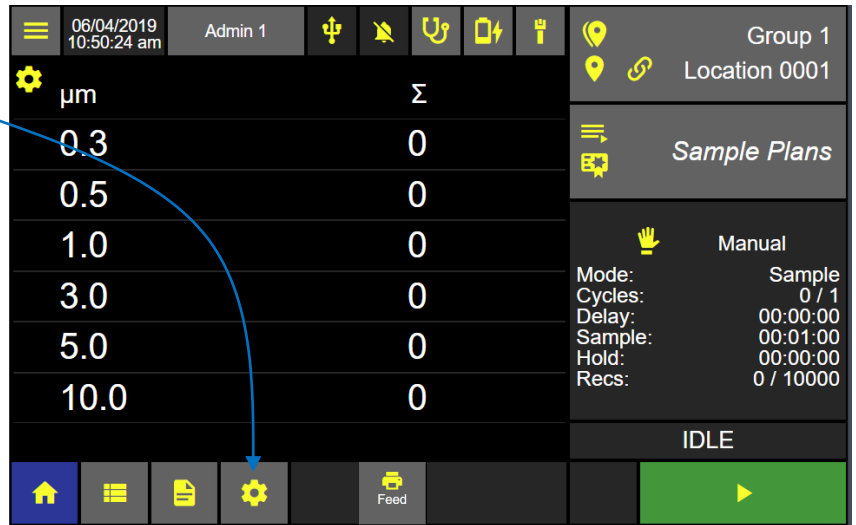

Settings: Sample Plans Screen

Press the Sample Plans button to display the Sample Plan Screen.

Add New Sample Plan

Press the Add New Sample Plan button to display the New Sample Plan Screen.

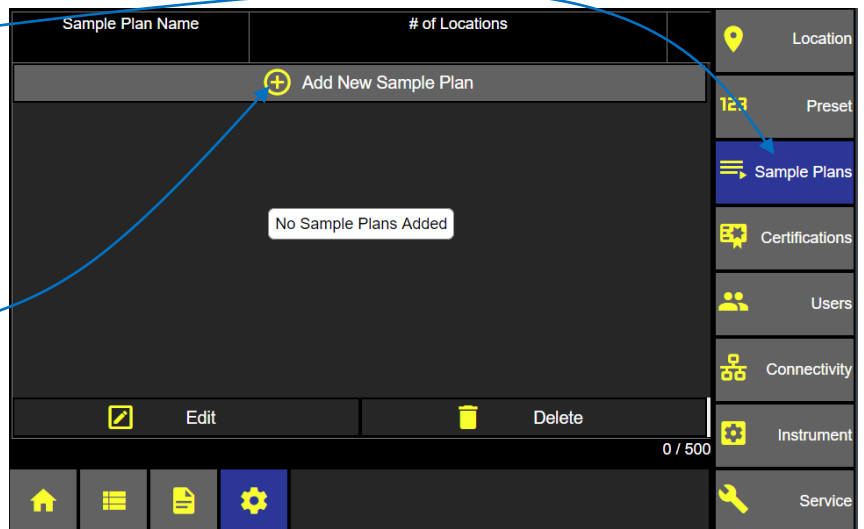

Add New Location to a Sample Plan

Press the Add New Location button to display the Sample Plan Setup Dashboard.

New Sample Plan Screen

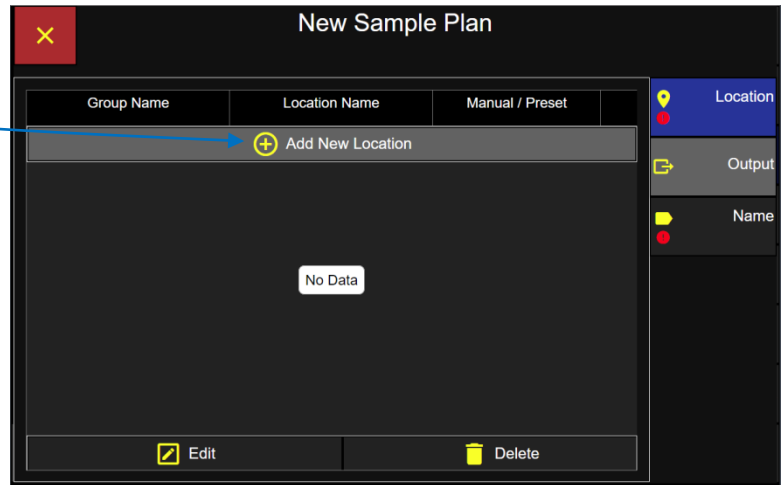

Sample Plan Setup Dashboard – No group selected

If no group is selected (note the Group Name in this example has a dark grey background color) then all locations will display and be selectable.

If a selected location is linked to a preset then the Preset button will highlight blue and the manual sample settings button will become disabled. Only the preset linked to the location will appear in the Preset Name list.

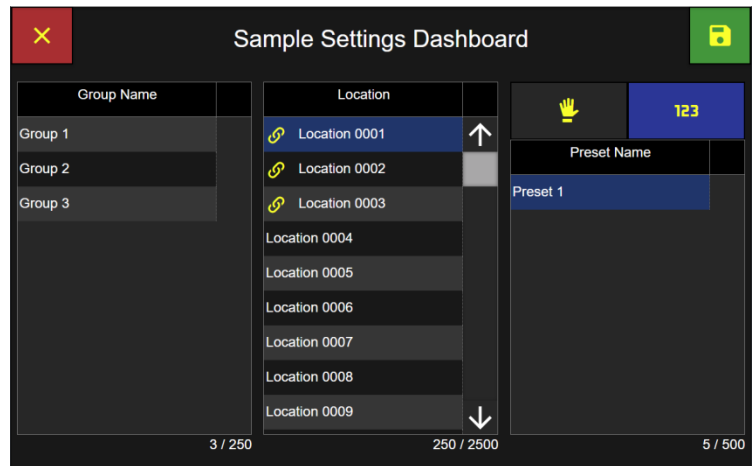

Sample Plan Set Up Dashboard - Group name selected

Select a Group name and only those locations assigned to that group will display.

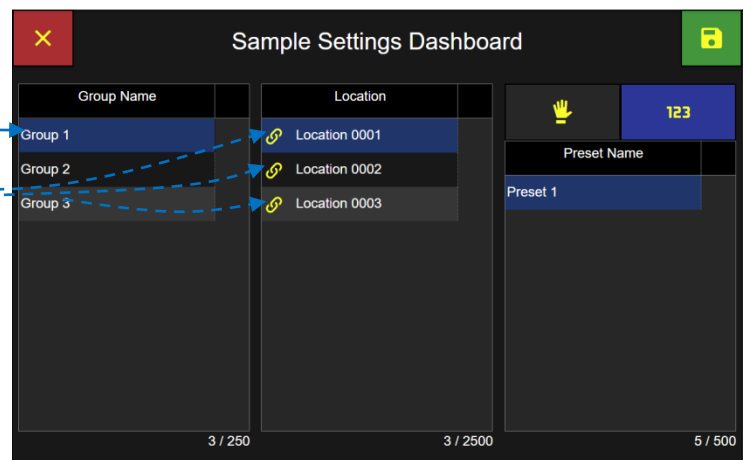

Sample Plan Setup Dashboard

Select Locations for Sample Plan

Select a Location from the list and it will highlight blue indicating it has been selected.

Manual - Sample Settings

Click on the Manual button and it will highlight blue indicating it has been selected.

Select the Manual Sample Settings button to display the Manual Sample Settings screen.

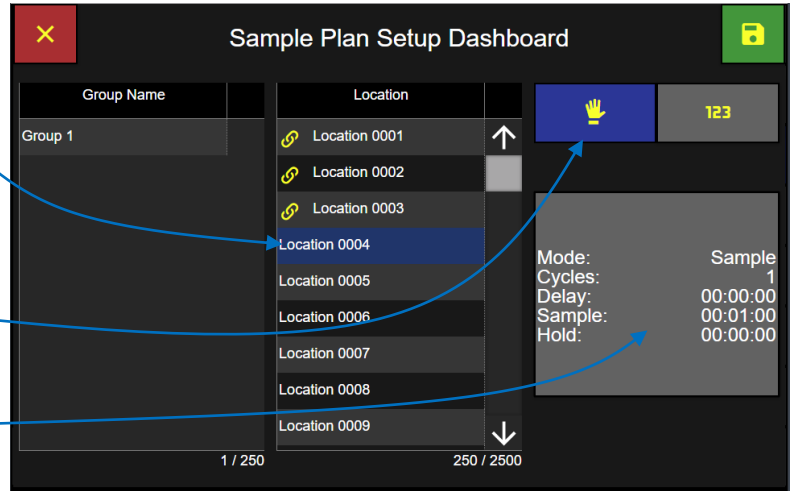

Sample Plan Manual Sample Settings

Delay Time

Select the Delay button and enter the delay time using the keypad and press the green Apply button.

Sample Time

Select the Sample Time button and enter the sample time using the keypad and press the green Apply button.

Hold Time

Select the Hold button and enter the hold time using the keypad and press the green Apply button.

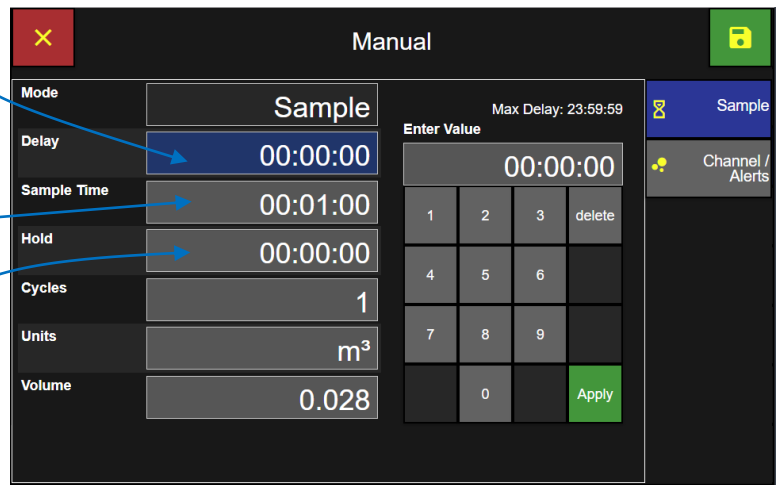

Delay Time

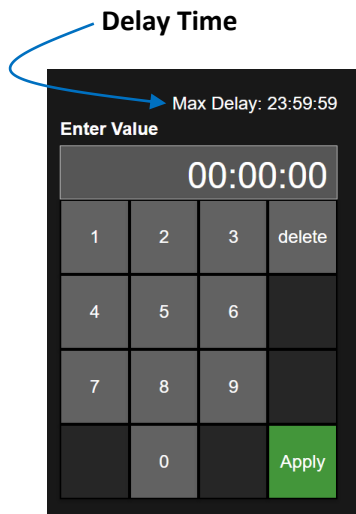

Sample Time

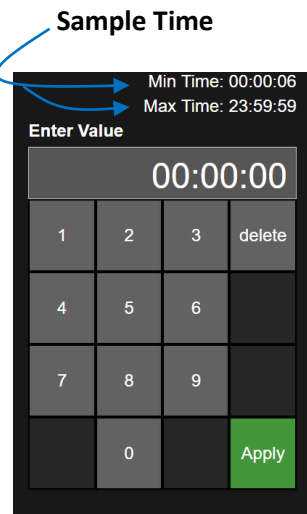

Hold Time

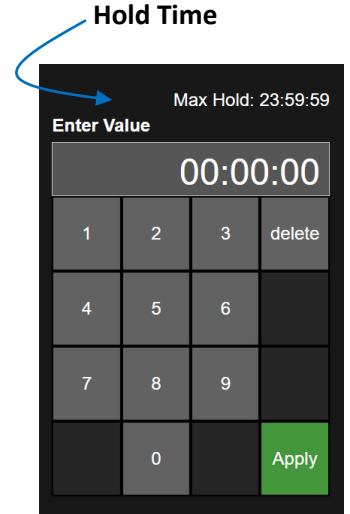

Sample Plan Manual Sample Settings

Cycles

Select the Cycles button and enter the number of Cycles using the keypad and press the green Apply button.

Units

Select the Units button and select the units, ft3 (cubic feet), m3 (cubic meters) or L (liters).

Volume

Select the Volume button and enter the sample volume with the keypad and press the green Apply button.

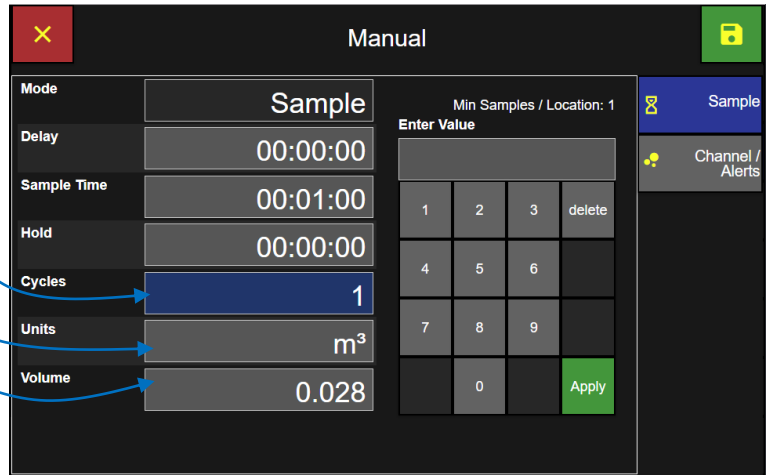

Number of Cycles

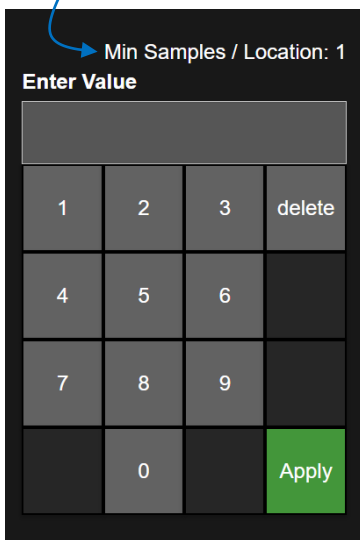

Units of volume

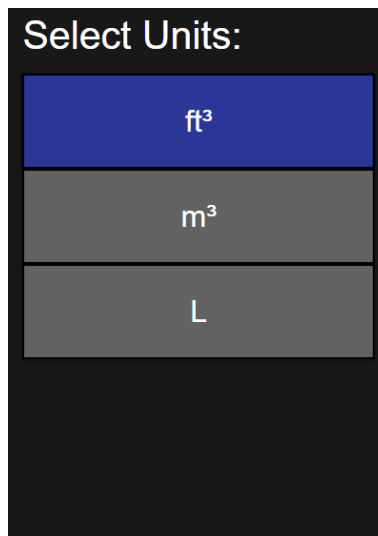

Volume

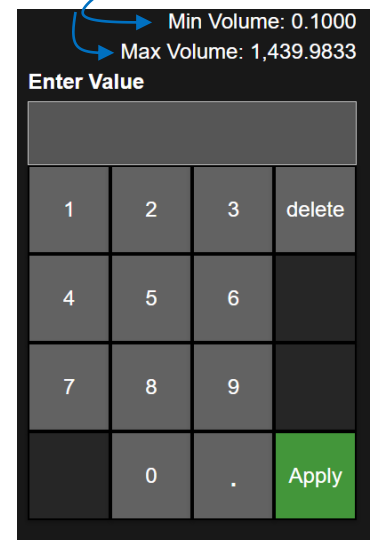

Press the Channel/Alerts buttons to display the Channel, Warning and Alarm input screen.

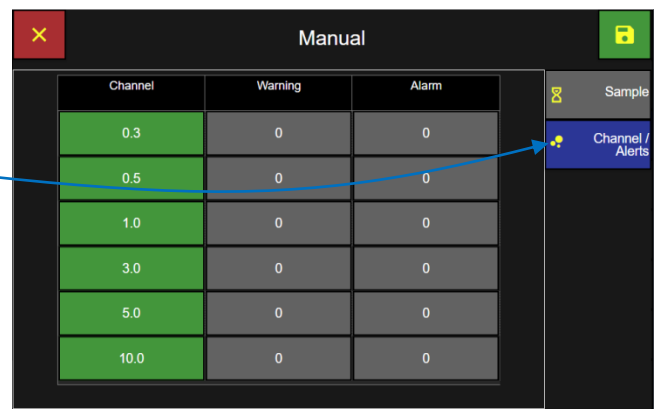

Enable or Disable Channel Sizes

Each particle size channel can be enabled (green) or disabled (grey). If a particle size channel is disabled then no data will be reported on that particle size channel.

Green = Enabled Channel

Grey = Disabled Channel

Note: If Lock Global Channels is enabled then all channels are locked. Additional channels may not be enabled or disabled.

Manual Sample Plan: Channel, Warning and Alarms

Channel	Warning	Alarm
0.3	0	0
0.5	0	0
4.0	0	0
3.0	0	0
5.0	0	0
10.0	0	0

Enter Warning and Alarm Thresholds

Press a Warning or Alarm threshold button to enter particle count threshold values for that particle channel size. Press the Enable button to enable the threshold setting. Or press the Disable button to disable the threshold.

Warning Threshold

0

Enable Disable

Enter Warning 10

1	2	3	delete
4	5	6	
7	8	9	
	0		Apply

Alarm Threshold

0

Enable Disable

Enter Alarm 20

1	2	3	delete
4	5	6	
7	8	9	
	0		Apply

Enter the warning or alarm threshold particle count value.

Press the green Apply button.

Manual Sample Plan: Channel, Warning and Alarms

Red button color indicates the channel alarm threshold is enabled.

Orange button color indicates the channel warning threshold is enabled.

Dark grey button indicates channel disabled.

Light grey button indicates threshold disabled.

Channel	Warning	Alarm
0.3	0	0
0.5	10	20
1.0	0	0
3.0	0	0
5.0	5	10
10.0	0	0

Press the green save button to save the Manual Sample settings to the highlighted location and redisplay the Sample Plan Setup Dashboard.



Manual Sample Plan Dashboard

Add location with settings to the Sample Plan

Press the green Save button to save the highlighted location with settings to the Sample Plan.

Group Name	Location
Group 1	Location 0001
	Location 0002
	Location 0003
	Location 0004
	Location 0005
	Location 0006
	Location 0007
	Location 0008
	Location 0009



Sample Plan with the first location added

In this example “Location 0004” has been added to the new sample plan.

Repeat the above process to add additional locations with Manual or Preset sample settings.

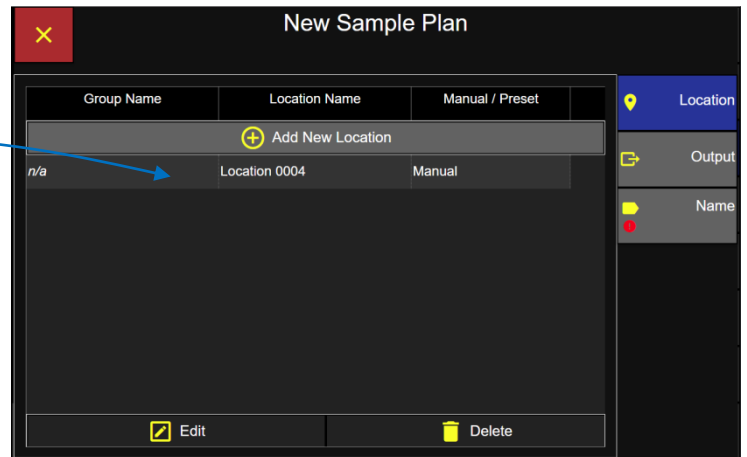

Preset - Sample Settings

Preset sample settings can be assigned to locations in a sample plan.



Press the preset button and it will highlight blue indicating it has been selected.

Select a location and it will highlight blue indicating that it has been selected.

Select a preset name and it will highlight blue indicating it has been selected.

Sample Plan Assigning a Preset to a Location

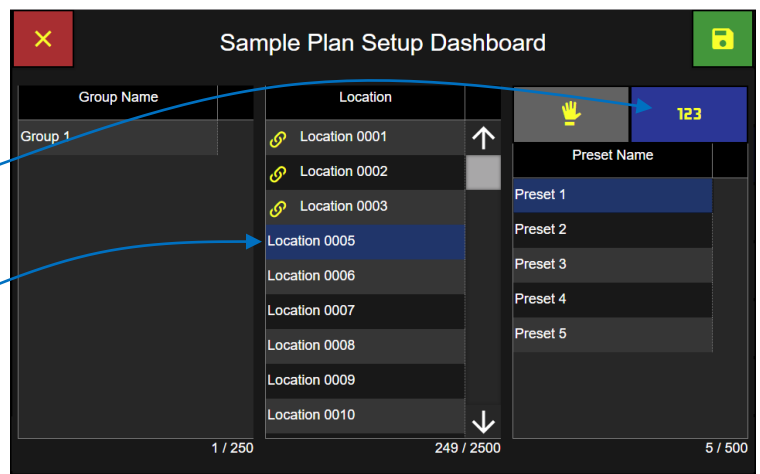

Press the green Save button to save the selected location with the selected preset sample settings to the new sample plan.

If a location is linked to a preset then the user will only be able to use that preset sample settings at that location. If a location is not linked to a preset then the user can chose any preset or set up manual sample settings. Note if the location selected already has a Preset assigned to it then only that preset name will be listed on the preset name list. This is because a location may be assigned only 1 preset setting.

Sample Plan with 3 locations added

Example: 3 locations assigned to a Sample Plan.
 The first location has manual sample settings and the second two locations have Preset sample settings.

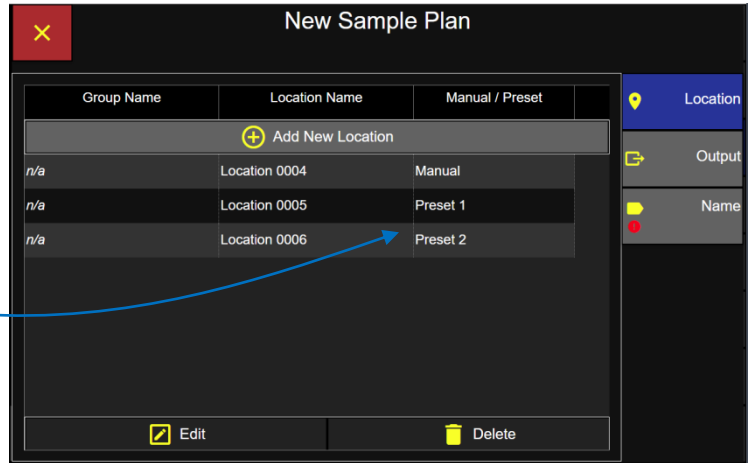

Output

Press the Output button to display the Print Output options:

Enable "On Sample" to print after every sample has been completed.

Enable "Average" to print the Average counts after every sample is completed.

Enable "On Alarm"
 To print after every alarm.

Sample Plan Output Print Options

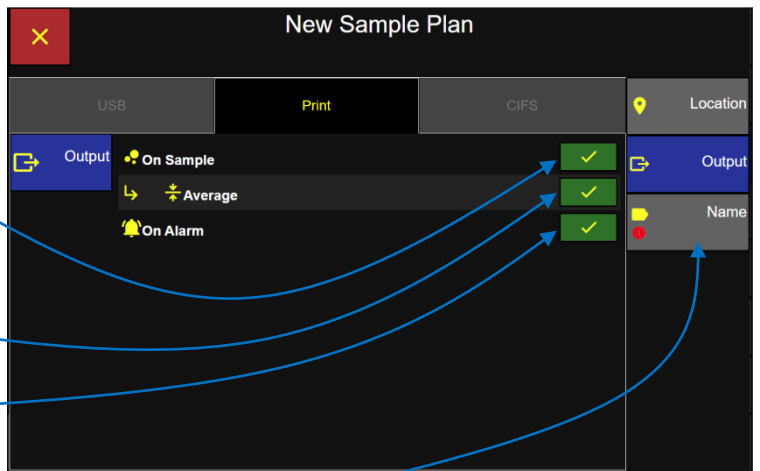

Press the Name button to display the Sample Plan Name screen.

Sample Plan Name Screen

Sample Plan Name

Enter Sample Plan Name using the keypad.

Press the green Apply button to apply the New Sample Name.

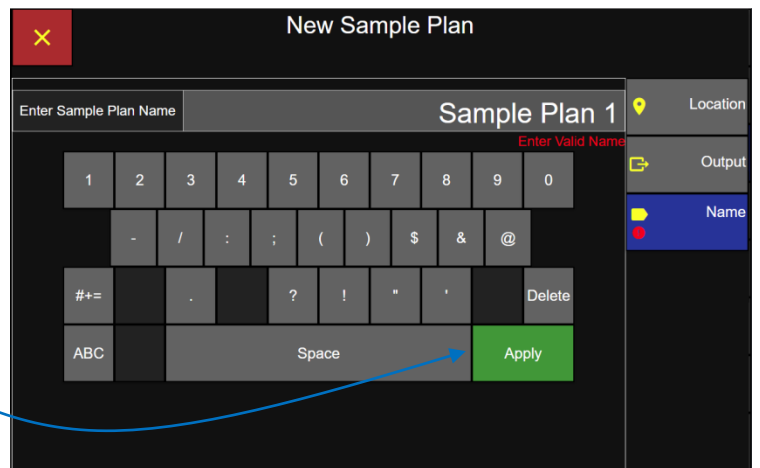
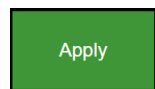

Save the Sample Plan Name



Press the green Save button to save the new sample plan.

Save Sample Plan

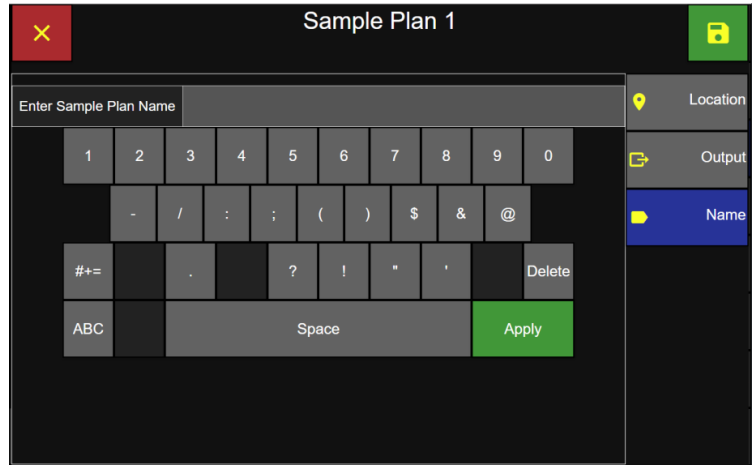

Settings Screen: Sample Plans

The new sample plan name is now listed on the Sample Plans screen.

The total number of locations included in the sample plan is listed in the # of locations column.

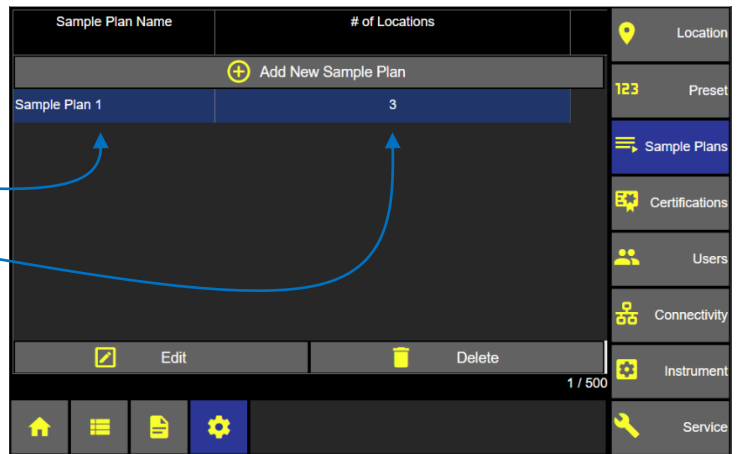

Edit Sample Plan

Select a sample plan to edit and it will highlight blue indicating it has been selected.

Press the Edit button to edit the sample plan.

Sample Plans Screen

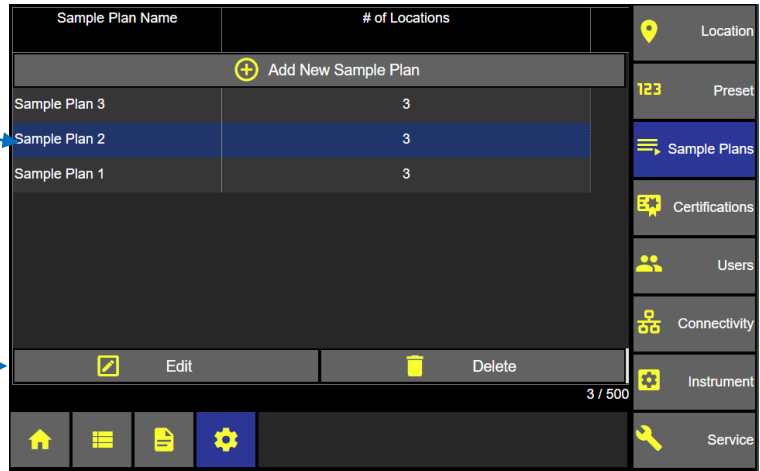

Edit Sample Plan Locations Screen

Press the Location button to edit the locations assigned to the sample plan.

Select a Location to Edit.

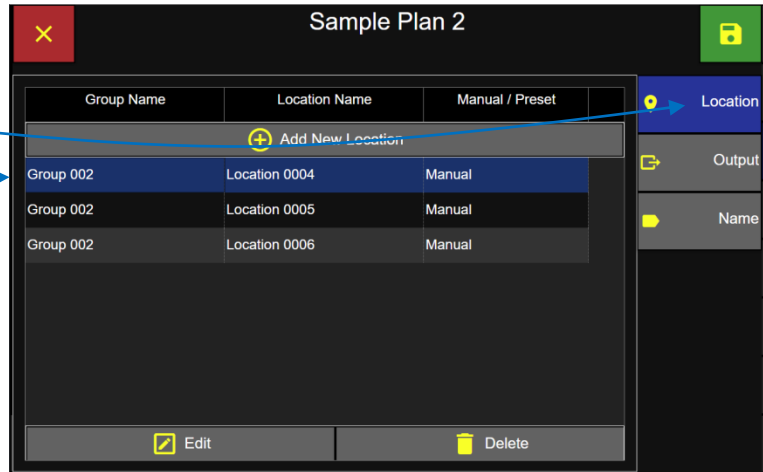

Edit Sample Plan Locations Screen

Edit the Manual or Preset Sample Settings

Press the Manual Settings button to select Manual Sample Settings.

Then press the sample setting button to edit the manual sample settings.

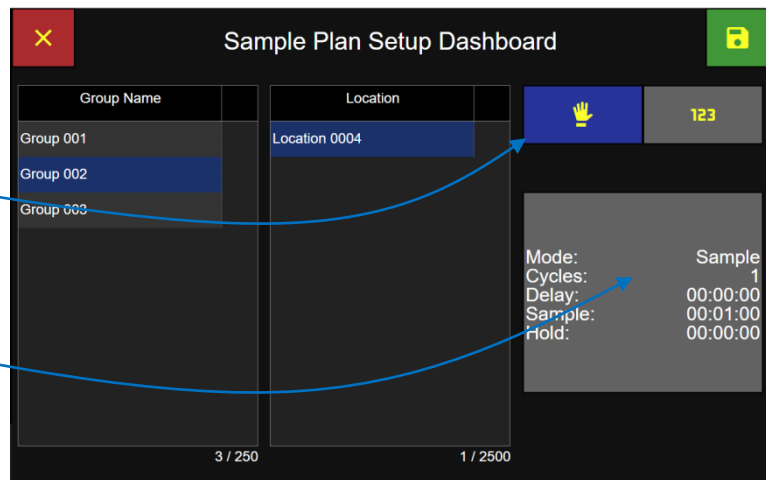

Manual Sample settings

Manual Sample Settings

Edit Manual Sample Settings.

Manual Channel/Alert settings

Manual Warning/Alarm Settings

Edit Warning and Alarm Settings.

Channel	Warning	Alarm
0.3	0	0
0.5	0	0
1.0	0	0
3.0	0	0
5.0	0	0
10.0	0	0

Warning Threshold

Alarm Threshold

Preset Sample Settings

Select Preset for this location.



Press the green Save button to save the Preset sample setting at the selected location.

Select Preset for Location

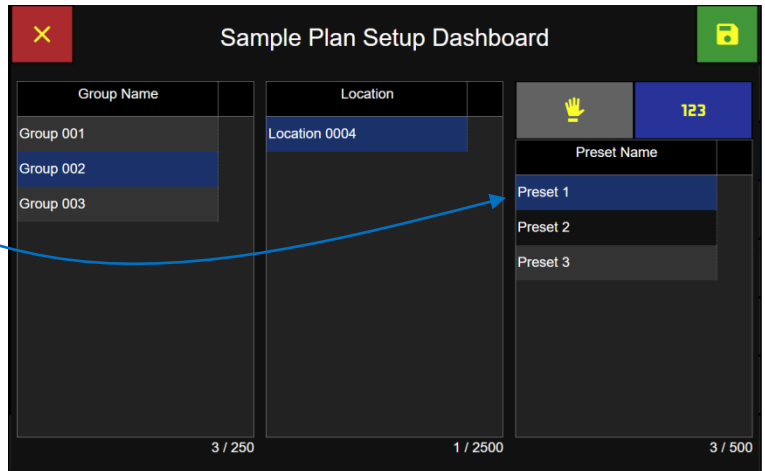

Edit Sample Plan Output

Press the On Sample button to enable output to the printer after every sample completes.

Press Average to print the average count of the total cycles in a sample.

Press On Alarm to output to the printer after every Alarm threshold is exceeded.

Select Output on Sample or on Alarm

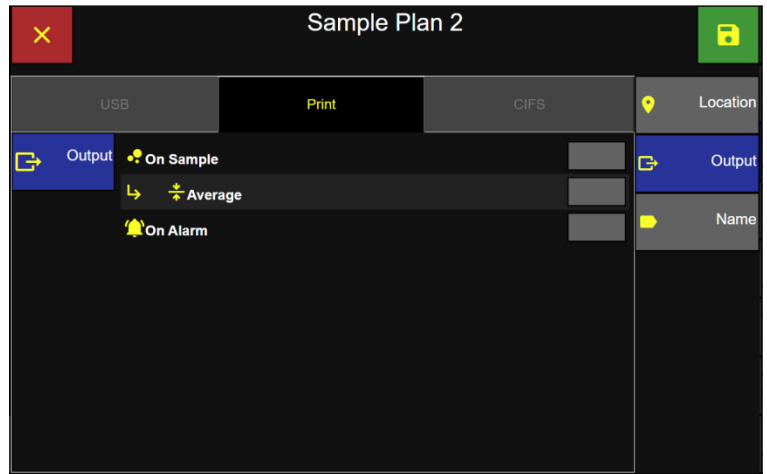

Edit Sample Plan Name

Press the Name button to edit the sample plan name.

Edit the name using the keypad.

Press the green Apply button to apply the edited sample plan name.

Press the green Save button to save the edited sample plan settings.

Sample Plan Name Screen

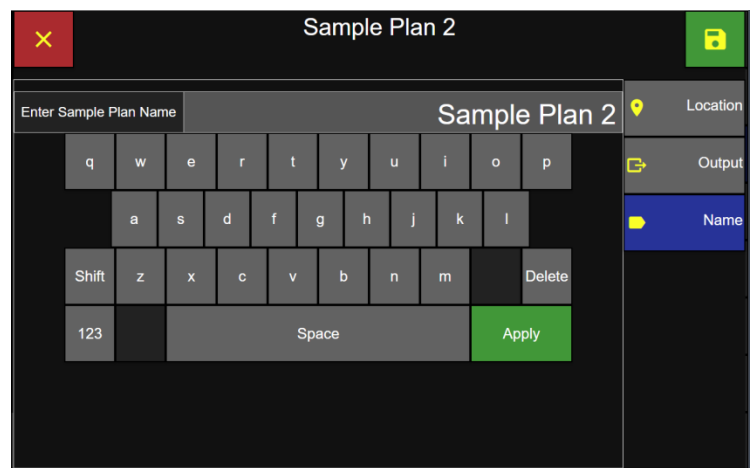

Delete Sample Plan

Select the Sample Plan to be deleted and it will highlight blue indicating it has been selected.

Press the Delete button.

Sample Plan Screen

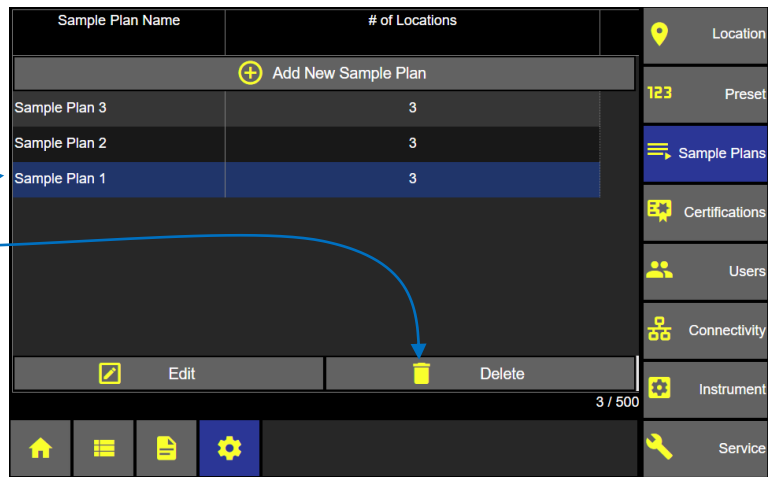

Press the green check box to confirm deleting the selected Sample Plan.

Or press the red x button to cancel.

Confirm Deleting Sample Plan

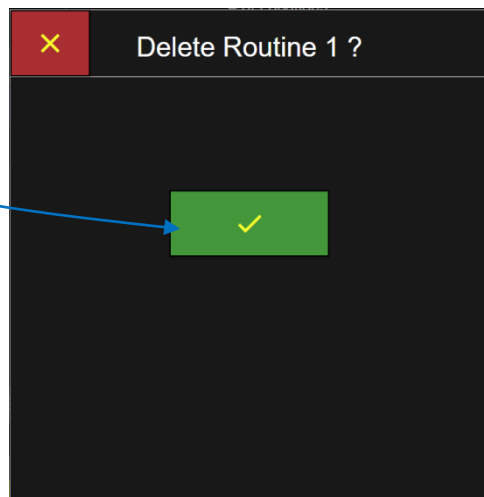

Blank Page

Certifications

Add a Certification

From the Home screen press the Configuration button and then press the Certifications button to display the Certifications screen.

Select the + Add New Certification button to display the New Certification input screen.

Settings: Certifications Screen

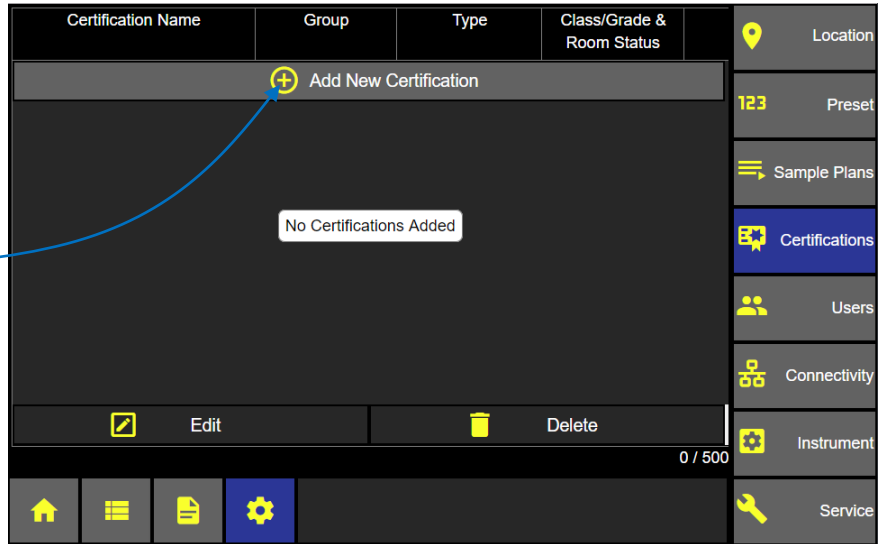

Certification Types

Select the certification type.

- ISO 14644-1: 2015
- EU GMP Annex 1
- ISO 14644-1: 1999
- Federal Standard 209E

New Certification Input Screen

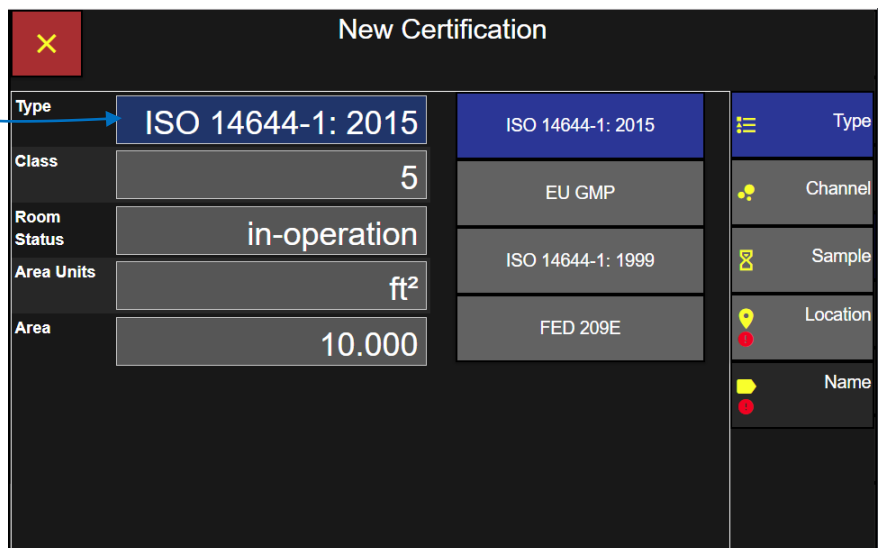

Cleanroom Class

Class

Select the cleanroom Class from the classes available for the certification type selected.

ISO 14644-1: 2015

(available classes: 2.0, 2.5, 3.0, 3.5, 4.0, 4.5, 5.0, 5.5, 6.0, 6.5, 7.0, 7.5, 8.0, 8.5, 9)

The screenshot shows a 'New Certification' form with the following fields and values:

- Type: ISO 14644-1: 2015
- Class: 5
- Room Status: in-operation
- Area Units: ft²
- Area: 10.000

To the right of these fields is a grid of class/grade options:

2	2.5
3	3.5
4	4.5
5	5.5
6	6.5
7	7.5

The '5' in the 'Class' field and the '5' in the grid are highlighted in blue. A blue arrow points from the '5' in the 'Class' field to the '5' in the grid.

Certification Classes & Grades

The available classes/grades will change according to the certification type selected above.

Certification Types

Available Classes & Grades

EU GMP Annex 1

(Available Grades: A, B, C, D)

A	B
C	D

ISO 14644-1: 1999

(Available Classes: 2, 3, 4, 5, 6, 7, 8, 9)

2	3
4	5
6	7
8	9

Federal Standard 209E

(Available Classes: 10, 100, 1000, 10,000, 100,000)

10	100
1000	10000
100000	

Room Status

Certifications will require Room Status to be selected. Select in-operation, at-rest or as-built and the selected room status will highlight blue indicating it has been selected.

ISO 14644-1: 2015

New Certification			
Type	ISO 14644-1: 2015	in-operation	Type
Class	5	at-rest	Channel
Room Status	in-operation	as-built	Sample
Area Units	ft ²		Location
Area	10.000		Name

ISO 14644-1: 1999

New Certification			
Type	ISO 14644-1: 1999	in-operation	Type
Class	5	at-rest	Channel
Room Status	in-operation	as-built	Sample
Area Units	ft ²		Location
Area	10.000		Name

Federal Standard 209E

New Certification			
Type	FED 209E	in-operation	Type
Class	100	at-rest	Channel
Airflow	non-unidirectional	as-built	Sample
Room Status	in-operation		Location
Area Units	ft ²		Name
Area	10.000		

EU GMP Annex 1

New Certification			
Type	EU GMP	in-operation	Type
Grade	A	at-rest	Channel
Room Status	in-operation		Sample
Area Units	ft ²		Location
Area	10.000		Name

EU GMP certifications will be limited to Room Status of In-Operation or At-Rest only.

Airflow

For Federal Standard 209E Certifications, airflow will be required to select either “non-unidirectional” or “unidirectional”.

Type	FED 209E	non-unidirectional
Class	100	unidirectional
Airflow	non-unidirectional	
Room Status	in-operation	
Area Units	ft ²	
Area	10.000	

Area Units

Area Units

Press the Area Units button.

Select the ft² or m² area units.

The screenshot shows the 'New Certification' form with the following fields: Type (ISO 14644-1: 2015), Class (5), Room Status (in-operation), Area Units (ft²), and Area (10.000). A dropdown menu is open for the Area Units field, showing options for ft² and m². The ft² option is highlighted in blue. A red 'X' button is in the top left corner. On the right side, there is a vertical menu with options: Type, Channel, Sample, Location, and Name, each with a corresponding icon.

Area

Area

Click on the Area button and the numeric keypad will pop up.

Enter the Area value.

Press the green Apply button.

The screenshot shows the 'New Certification' form with the same fields as the previous image. A numeric keypad is overlaid on the right side of the form. The keypad has buttons for digits 1-9, 0, a decimal point, and a 'delete' button. A green 'Apply' button is at the bottom right of the keypad. The Area field now contains the value '10.000'. The 'Area Units' field is still set to 'ft²'. The 'Enter Value' label is above the keypad. The red 'X' button and the right-side menu are also visible.

Press the Channel button to display the New Certification Channels screen next.

Certification Channels

Channels

Certification channel sizes are limited and locked according to the certification type.



Enabled channels will appear with a green check box.



Disabled channels appear with a red x box.

Press the green check box to disable a channel and it will change to a red x box and vice-versa.

Size	Enable	Target Limit / m ³
0.3 µm	✗	10200
0.5 µm	✓	3520
1.0 µm	✓	832
3.0 µm	⊘	
5.0 µm	⊘	
10.0 µm	⊘	

Some allowed channels are not enabled

Note the on screen message “Some allowed channels are not enabled”.

In this example the 0.3 µm size particle channel is an allowed channel but it was disabled.



The dark grey null set button indicates this channel size is not included in the certification.

Press the Sample button to display the certification sample settings next.

Sample settings for new Certification.

Delay Time

Select the Delay button and enter the delay time using the keypad and press the green Apply button.

Sample Time

Select the Sample Time button and enter the sample time using the keypad and press the green Apply button.

Hold Time

Select the Hold button and enter the hold time using the keypad and press the green Apply button.

Delay Time

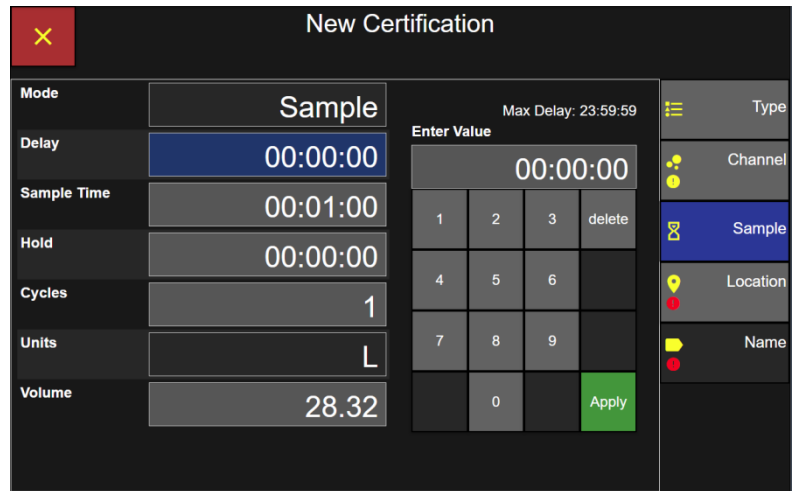

Delay Time

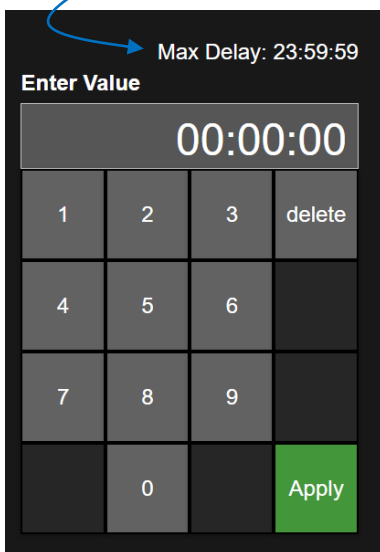

Sample Time

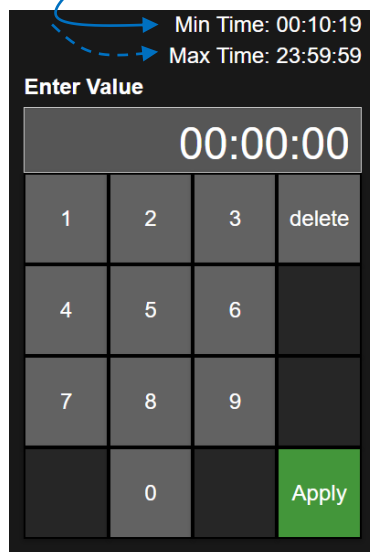

Hold Time

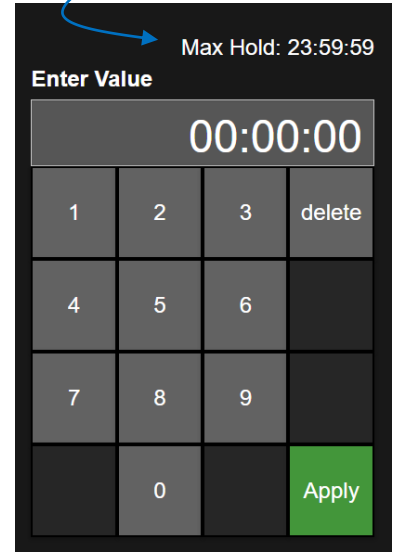

Cycles

Select the Cycles button and enter the number of Cycles using the keypad and press the green Apply button.

Volume

Select the Volume button and enter the sample volume with the keypad and press the green Apply button.

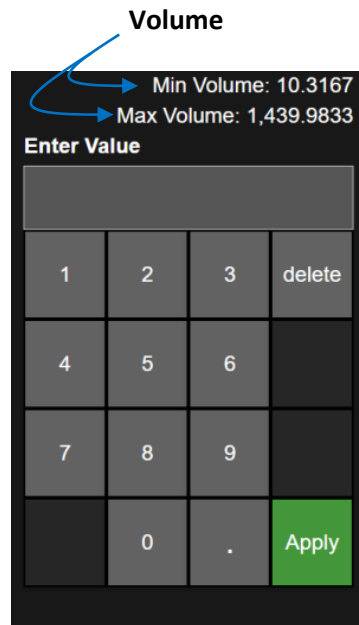
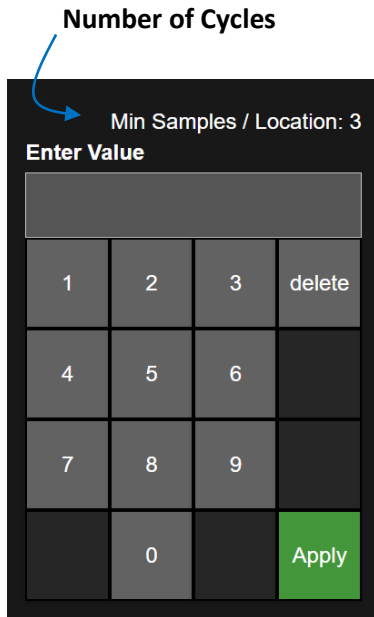

Select the Location button next to display the certification location selection screen.

Locations

If a Group Name is selected then only those locations assigned to that group will display in the Location List.

Certification: Locations

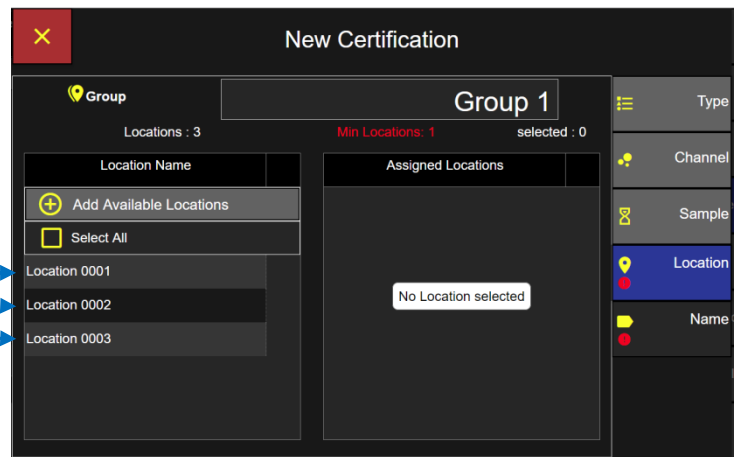
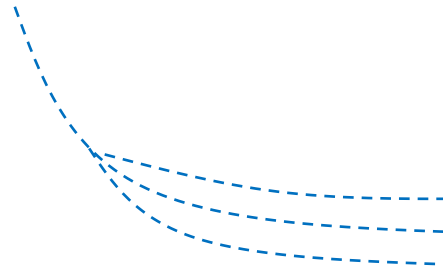

If no Group Name is selected the all locations will be available to be assigned to the new certification.

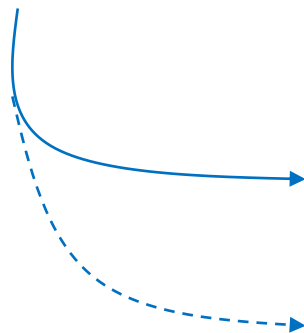

Certification: Locations

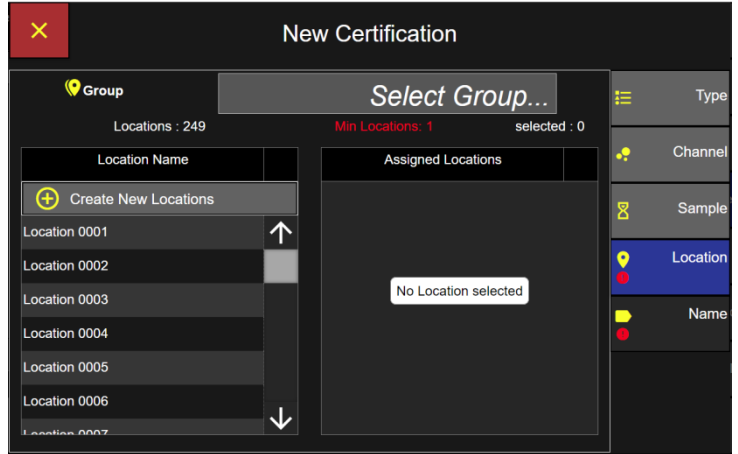

Certification Locations

Select one or more location names and each will highlight blue indicating it has been selected. Each location selected will be displayed under the Assigned Locations column.

To undo a selected location from the assigned list simply press the location name to de-select and it will highlight grey and that location will be removed from the assigned locations list.

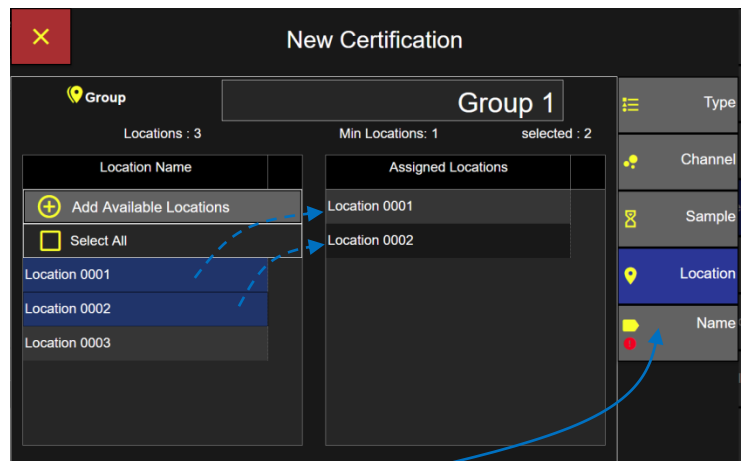

Press the Name button to display the Enter Certification Name screen next.

Certification Name - Apply

Enter the New Certification name using the keypad. Press the green Apply button to apply the new certification name.

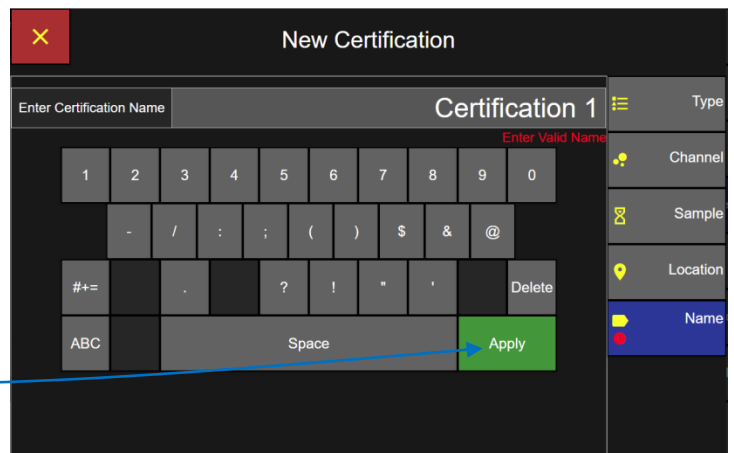
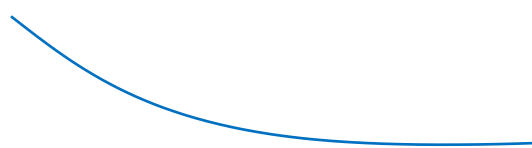
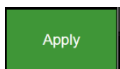

Certification Name



Press the green Save button to save the new certification.

Settings: Certifications Screen

The new Certification will display on the Settings Certification Screen.



Certification Name	Group	Type	Class/Grade & Room Status	Location
+ Add New Certification				
Certification 1	Group 1	ISO 14644-1: 2015	5, in-operation	123 Preset

Edit a Certification

From the Home screen press the Settings button and then press the Certifications button.

Select Certification to Edit

Select a Certification name to edit and it will highlight blue indicating it has been selected.

Press the Edit button to edit the highlighted certification.

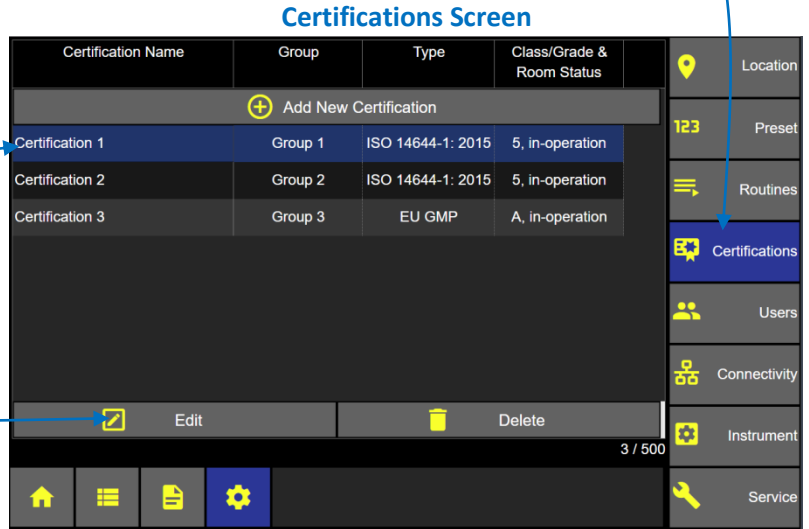

Edit certification settings

Select a certification setting button to edit for:

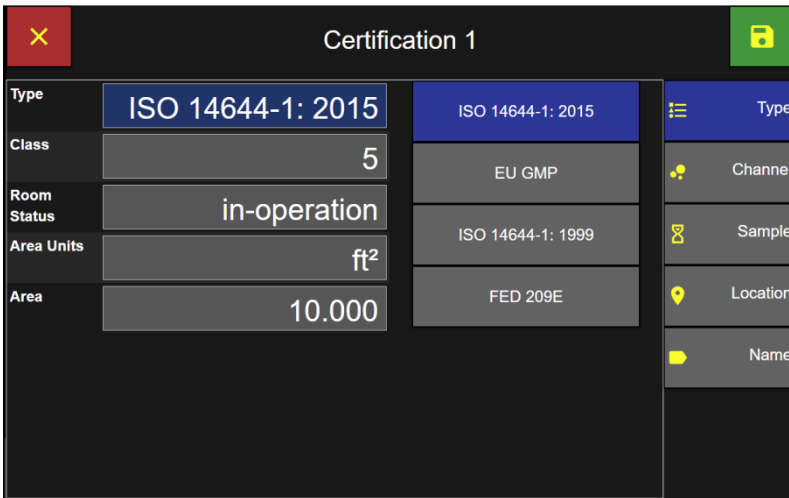

- Type
- Channel
- Sample
- Location
- Name

Press the green Save button to save the edits to the certification.

The edited certification will be saved to the certification names list on the certifications screen.

Delete a Certification

From the Home screen press the Settings button and then press the Certifications button.

Select Certification to Delete

Select the Certification name to delete and it will highlight blue indicating it has been selected.

Press the Delete button to display the delete confirmation pop up screen.

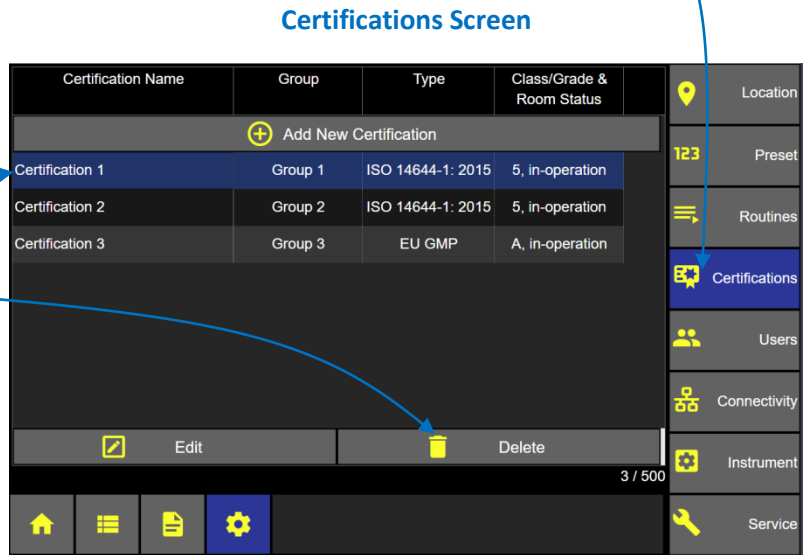

Confirm Delete Certification

Press the green check box to confirm deleting the highlighted certification.

Or press the red x box to cancel and no delete.

Confirm Configuration Delete

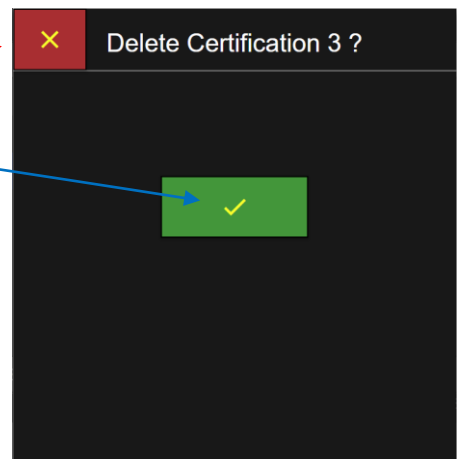

Blank Page

Users & Permission Levels

Users

ApexZ supports up to 1000 users and 10 user Permission Levels. Username and Password can be kept locally on the ApexZ unit or verified through Active Directory on your company network. ApexZ supports assigning Permission Levels to individual Active Directory Groups. In addition ApexZ can prioritize AD Groups and their respective permission levels.

User Name and Permission Levels Screen

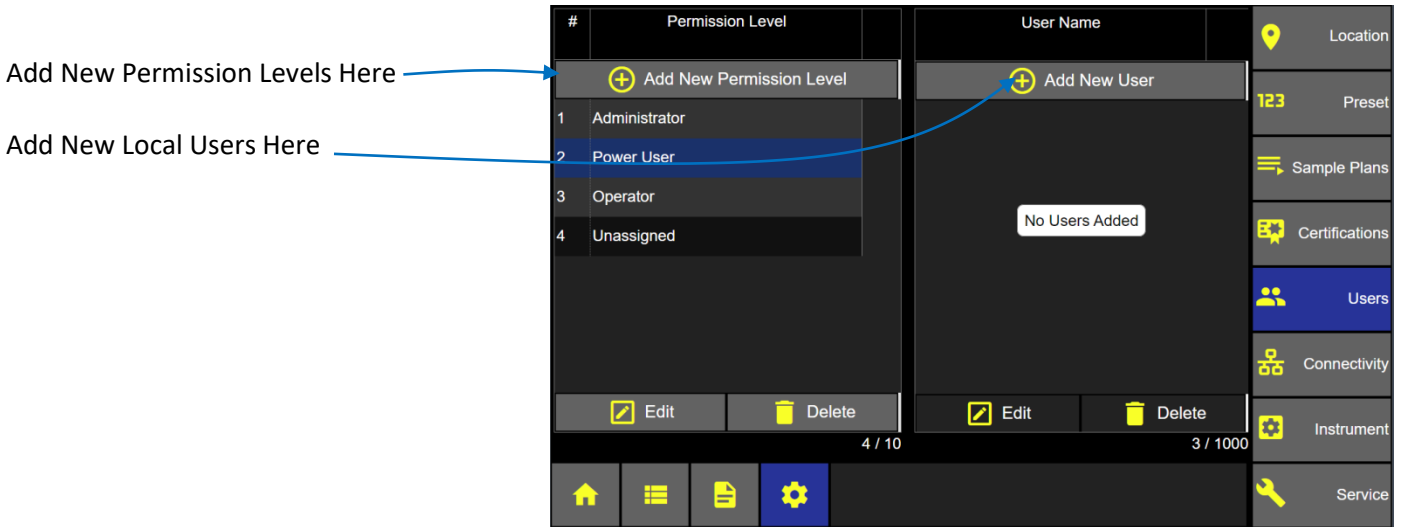

ApexZ supports up to 10 Permission Levels.

Administrator

Power User

Operator

Unassigned (only for unassigned users)

... up to 10 total permission levels.

User permissions can be enabled or disabled for each permission level created.

Operator and Power User Permission Levels can be edited or deleted.

The "Administrator" and "Unassigned" permission levels may not be edited or deleted.

Permission Levels Settings

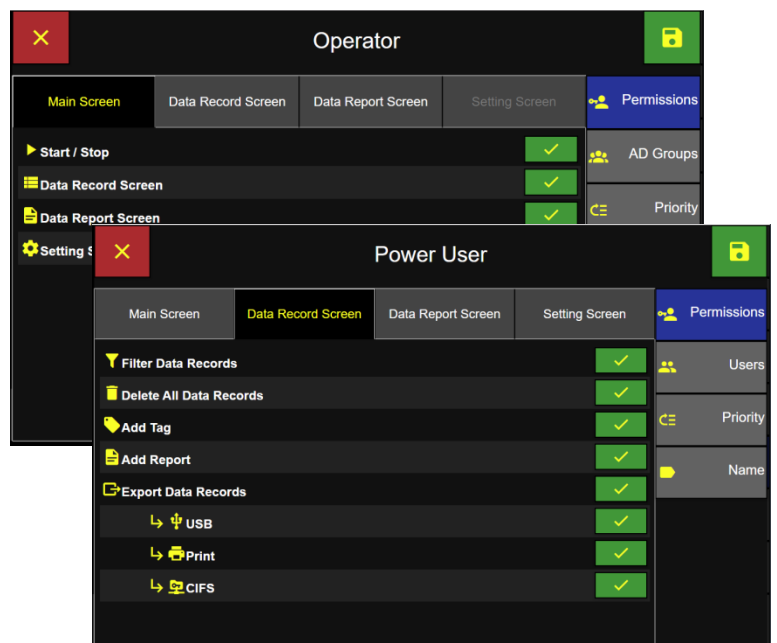

Add a New User

Press the **+** button to Add a New User

User Screen

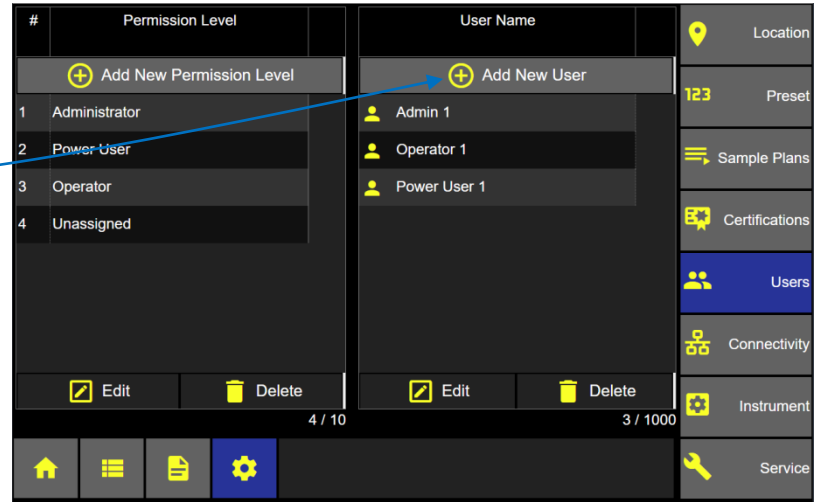

Note: In order to add new users Login as an Administrator level user or disable users.

User Type

User type "local" will verify Username and password saved locally on the ApexZ instrument.

User Type

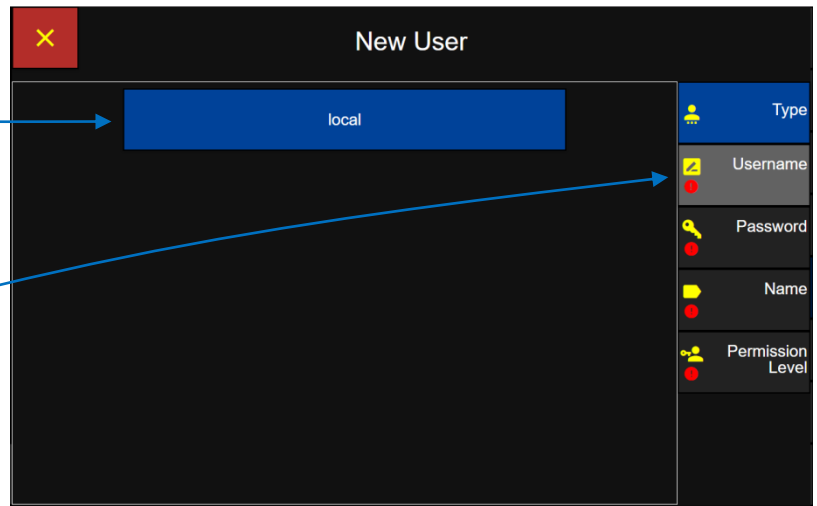

Next press the User name button.

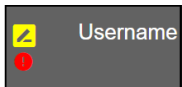

Note: When creating an Active Directory User no password is required. The password resides on the Network Active Directory.

Note: To enable Users, at least one Admin level user must be created first.

Username

Enter user name on keyboard.

Press the green apply button and the new username will display in the username box.

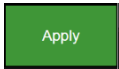

Next Press the Password button.

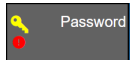

Username Screen

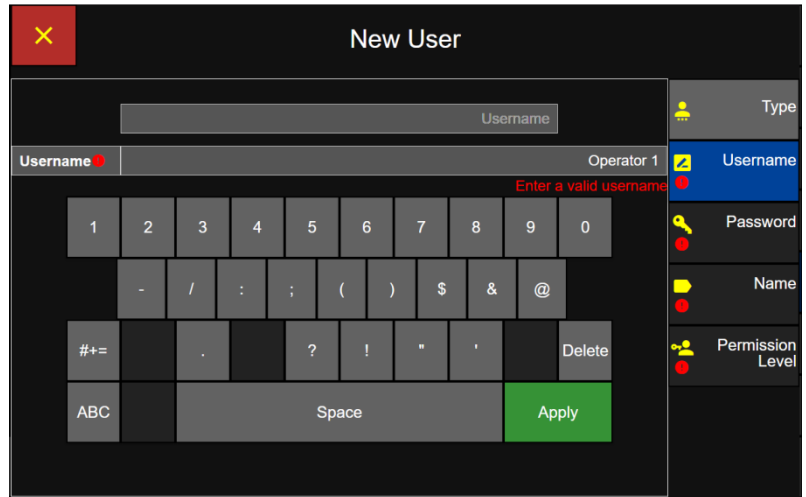

Password

Enter Password on the keyboard.

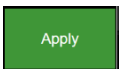

Press the green apply button to confirm password entered.

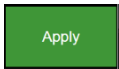

Re-enter the same password to confirm password then press the green apply button again to confirm.



Next Press the Name button.

Password Screen

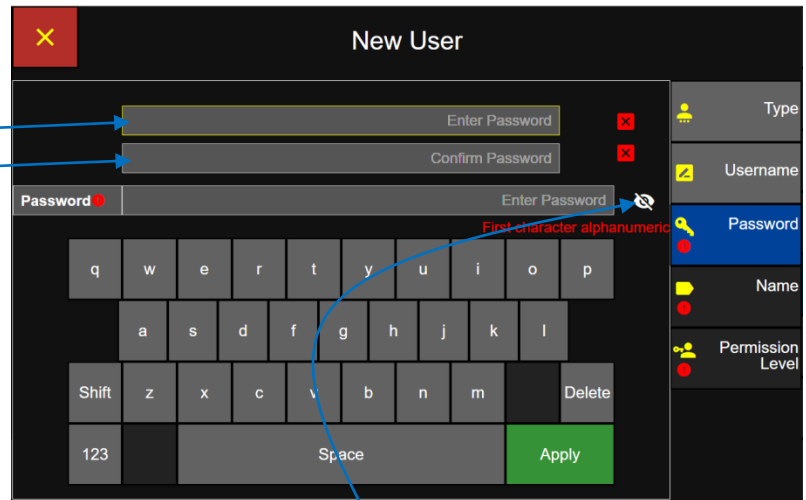

Click here to toggle view or hide password.

First and Last Name

Press the Name tab below the Password button to advance to the First and Last Name screen.

Enter First Name from the keyboard.

Press Apply and the first name will be displayed above.

Enter the Last Name from the keyboard.

Press Apply and the last name entered will be displayed in the last name box.

First and Last Name Screen

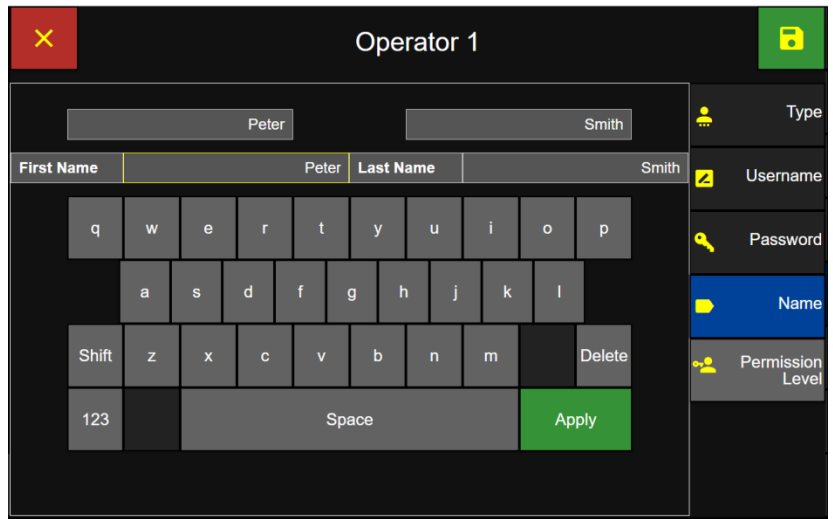

After successfully applying the first and last name; Press the Permission Level button to select the permission level.

Permission Level

Select a Permission Level; Administrator, Power User or Operator. The Permission Level will highlight blue indicating it has been selected.

Press the green save button to save the Permission Level and display the new user included on the user screen.

Select Permission Level Screen

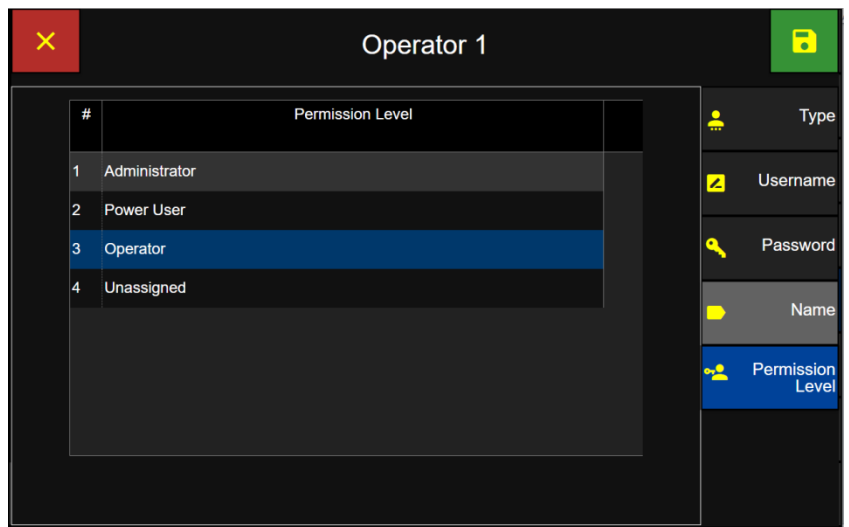

Edit User

To edit users, an Administrator level user must be logged in or Users must be disabled.

From the User screen select a User to edit from the list and the user name will highlight blue to indicate it has been selected.

Press the Edit button to display the User setting tabs.

Users Screen

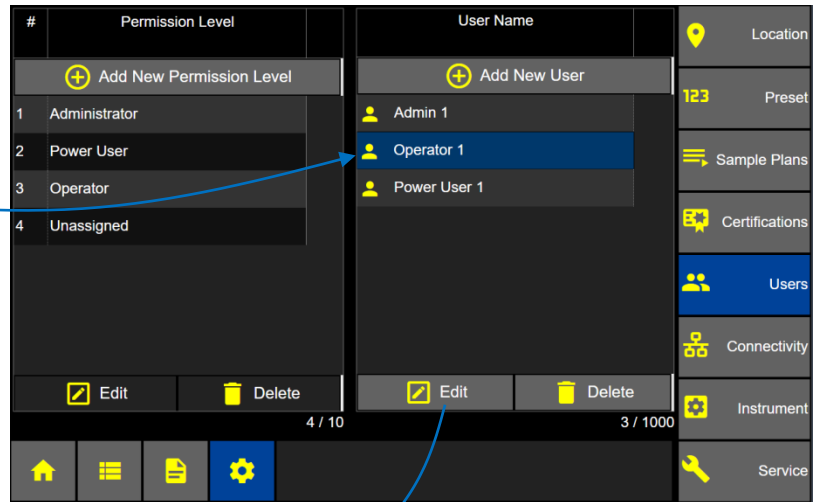

Users Screen

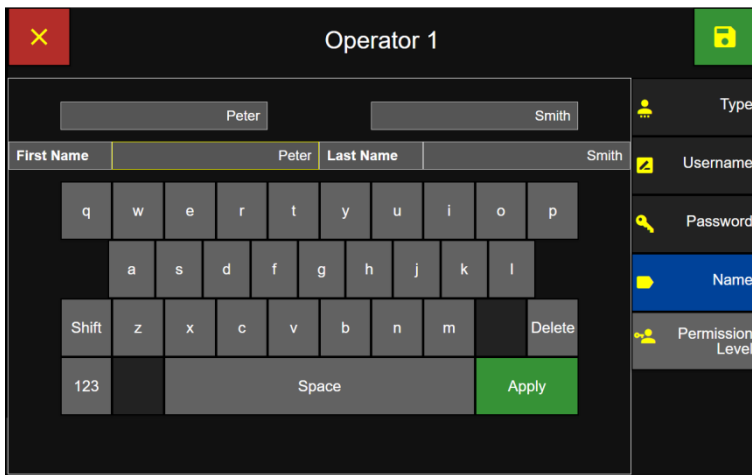

Note that the first three tabs Type, Username, Password are not available to edit.

The tabs for Name and Group are available to edit.

Press the **Name** button to edit the First and Last name.

Press the **Permission Level** button to edit the user Permission Level.



Press the green Save button to save the first and last name edits.

Note: Administrator level users can edit their own password but cannot edit other user passwords. If other users forget their password then a logged in Administrator Permission Level User will need to recreate their account.

Delete a User

Users Screen

From the User Screen; select the user name to delete. The selected user name will highlight blue.

Press the Delete button to delete the highlighted User.

The selected User Name will pop up and require a confirmation to delete.

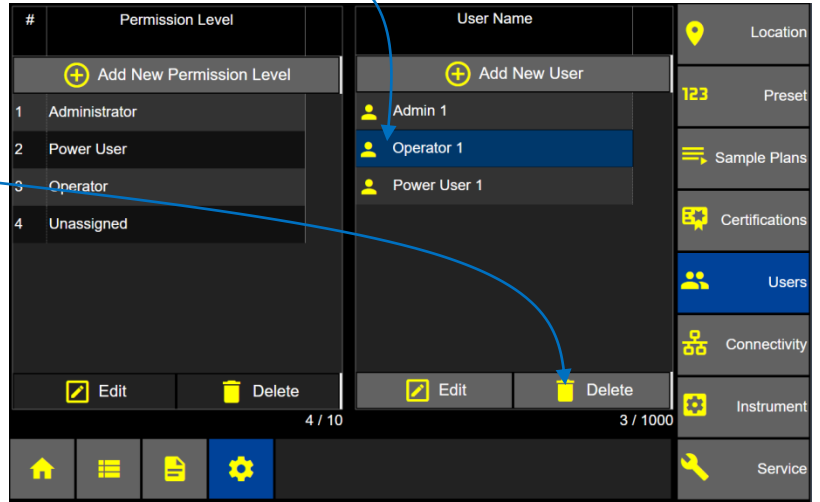

Confirm User Delete

Press the green check box to delete User.



Or press the red x button to cancel.

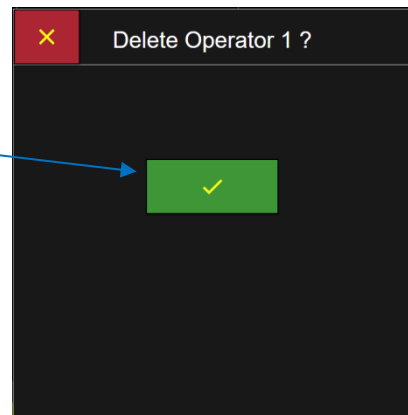
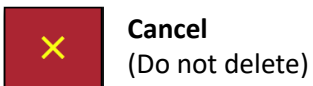

User Login

When Users are enabled ApexZ will require a Username and Password logon.

Enter Username and Password

Touch the Username box and the border will highlight yellow indicating it has been selected.

If Users are enabled then login with your local ApexZ Username and password.

If Active Directory is enabled then login with your network Active Directory username and password.

Login Screen

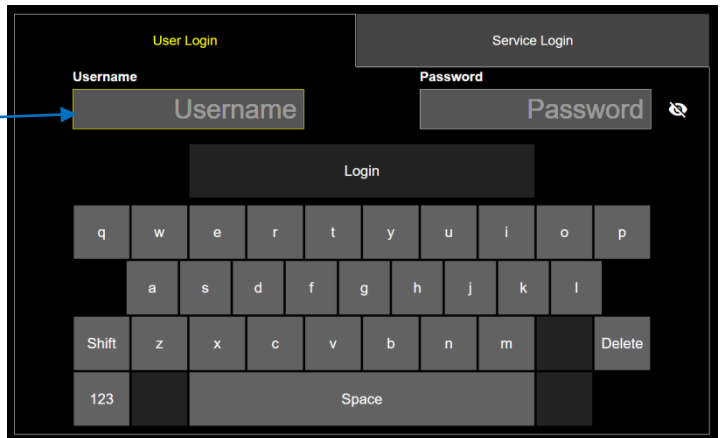

The username will display in the username box as you type.

Touch the Password button and the border will highlight yellow indicating it has been selected.

Enter your user password with the keypad.

The login button will illuminate green indicating it is ready to be selected.

Press the green Login button to login to the ApexZ.

Login Screen

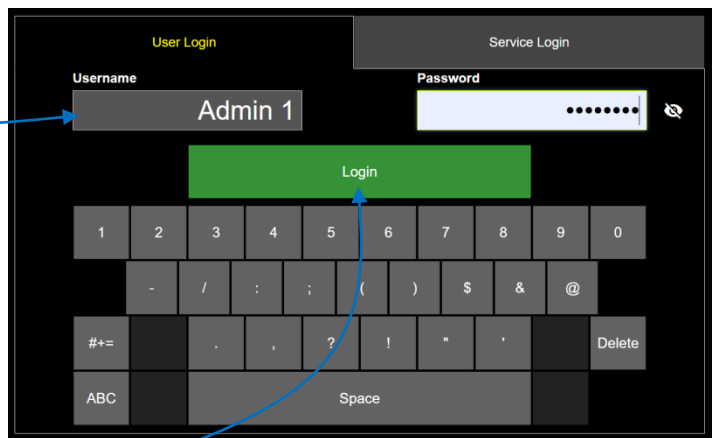

The logged in Username will be displayed on the Home page.

Home Screen

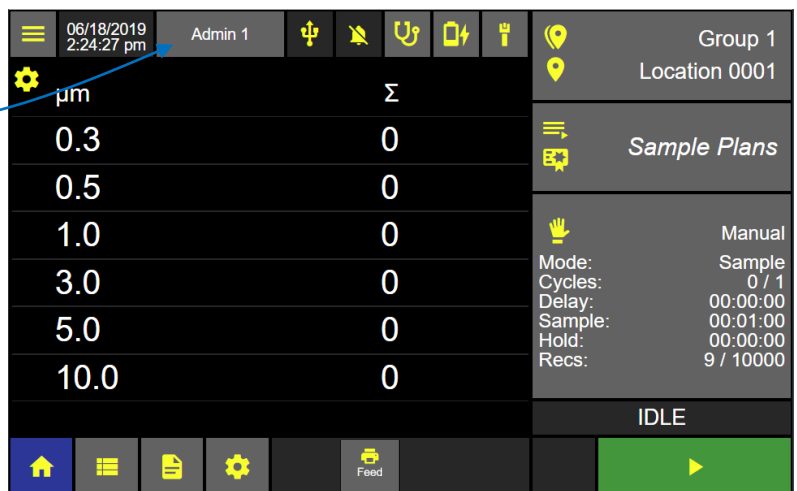

User Logout

Home Screen: User Enabled

Press the Username button to display the Logout screen.

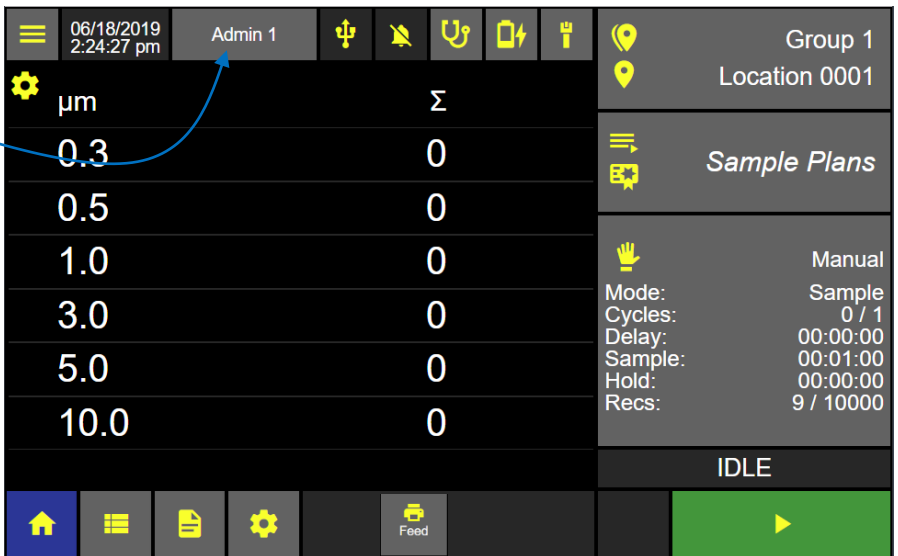

Note: If you press the Username button and it does not display the Logout screen check that Settings Instrument Options Users are “enabled”.

Logout Screen when ApexZ is idle

Press:
Logout to logout.
Lock to lock the screen.
Cancel to remain logged in.

ApexZ Idle

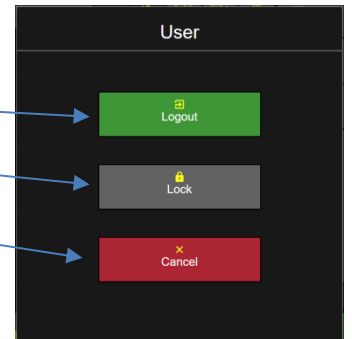

Logout Screen when ApexZ is sampling

Press:
Lock to lock the screen.
Cancel to remain logged in.

ApexZ Sampling

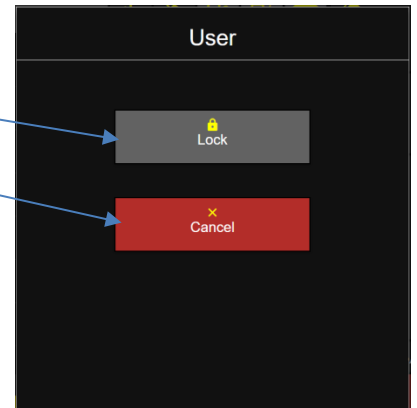

Administrator Permission Level

Administrator Permission level users have all ApexZ features enabled and no features may be disabled.

Add new Permission Level

User Screen – Add New Permission Level

Press the Add New Permission Level button to display the Add New Permission Level screen.

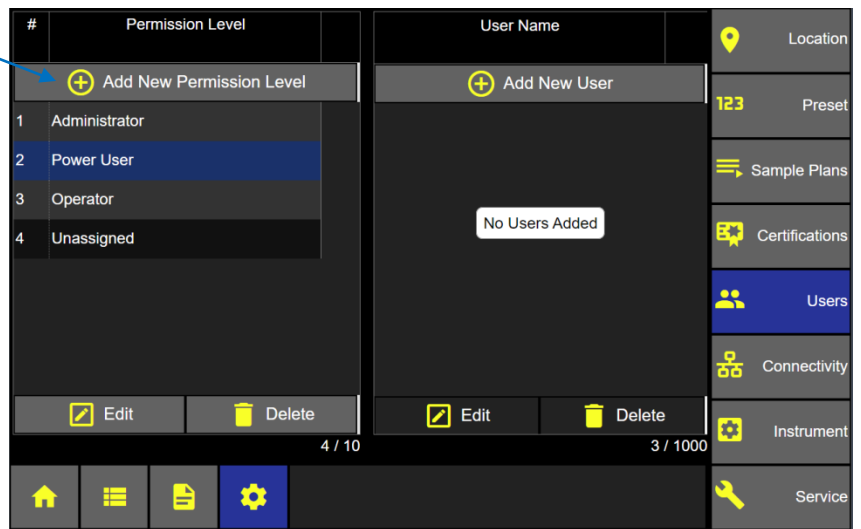

Edit "Power User" Permissions Screen

Select the screen tabs to edit permission levels.

- Main Screen
- Data Record Screen
- Data Report Screen
- Setting Screen

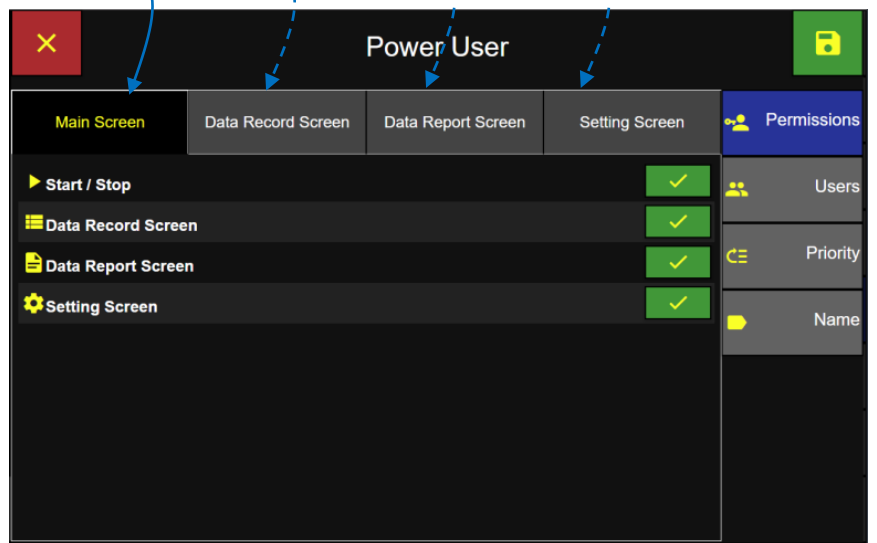

Edit Permission Levels

Select the screen tab to edit permissions for that screen.
Enable or disable any feature by pressing the button.



Press the green Save button to save the Permission Level settings.

Main Screen

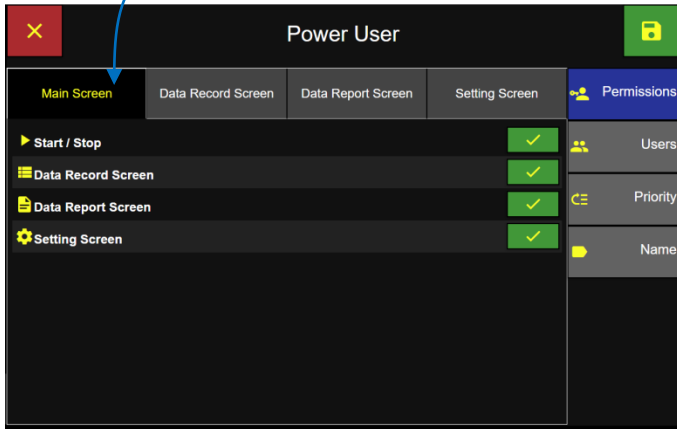

Data Record Screen

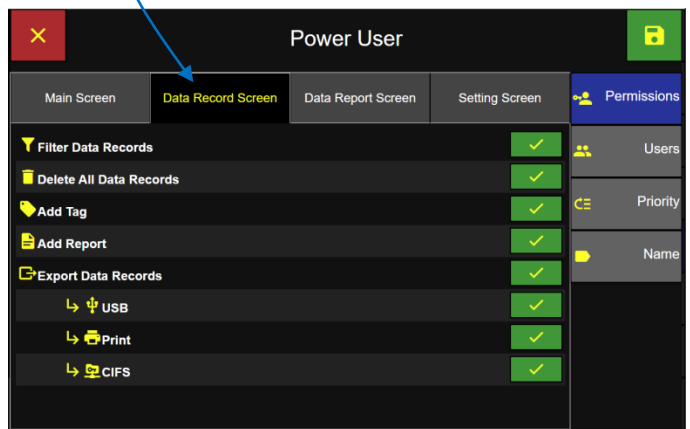

Data Report Screen

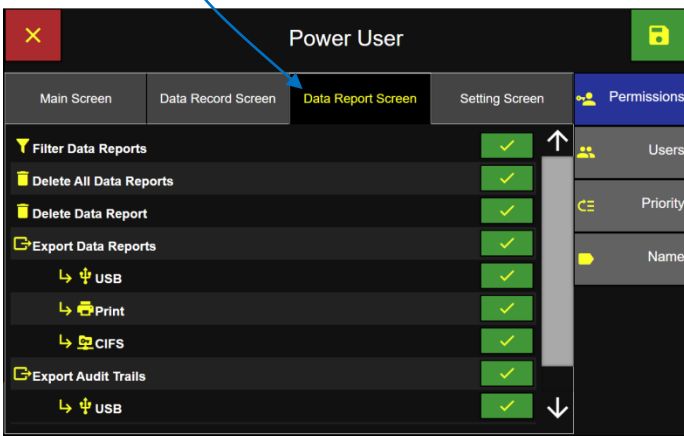

Settings Screen

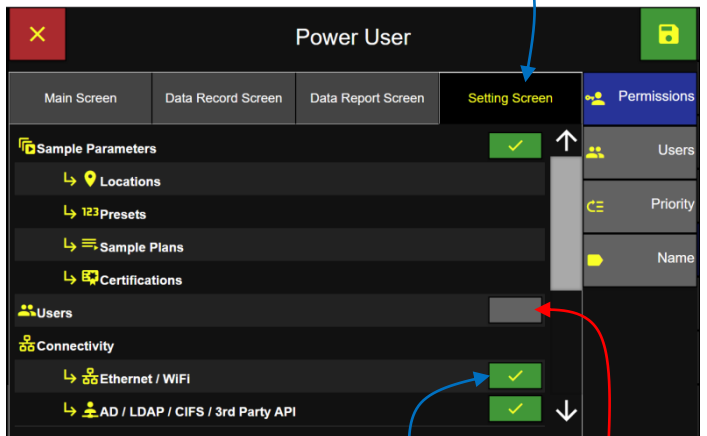

Enabled

Disabled

Assign AD Group to Permission Level

Active Directory Group names can be manually assigned to a Permission Level or by logging into the network and selecting from a list of AD Groups.

Manually Assign Permission Level

Press the + Manual button to display the Enter AD Group Name screen.

Assign Active Directory Group to Permission Level

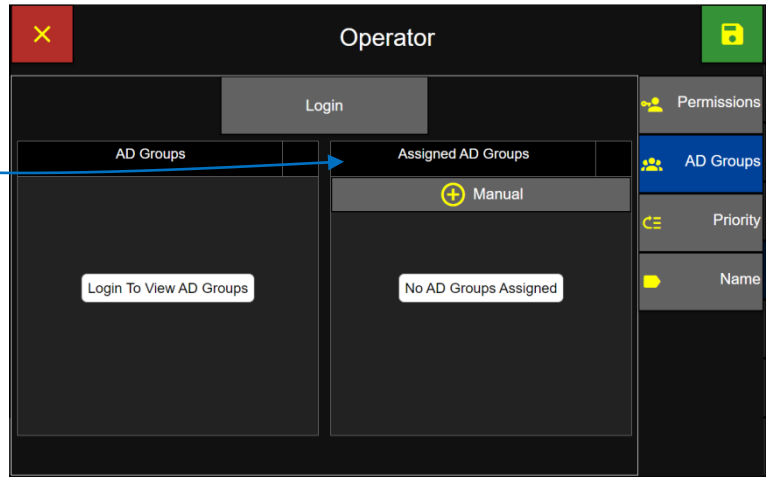

Enter Active Directory Group Name

Enter the AD Group Name to assign to the permission level.

Press the green Apply button.

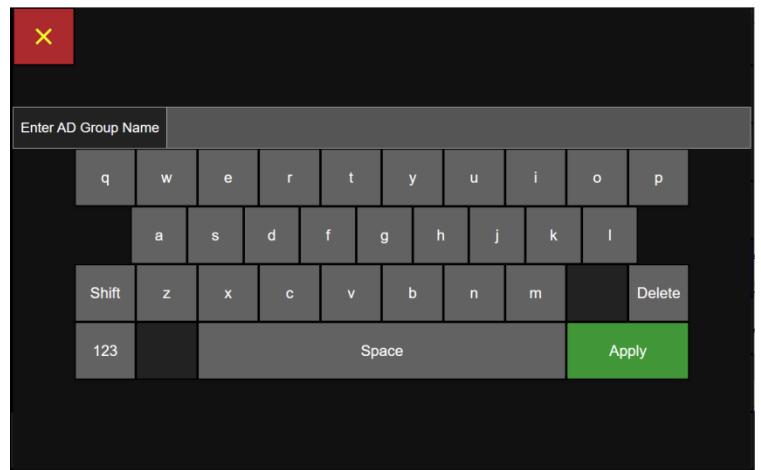

Login to select AD Groups and assign Permission Levels

Note: To login and display network AD Groups the AD URL and Domain must be entered in the ApexZ Settings Connectivity AD/LDAP screen.

Press the Login button to login to the Active Directory.

Assign Active Directory Group to Permission Level

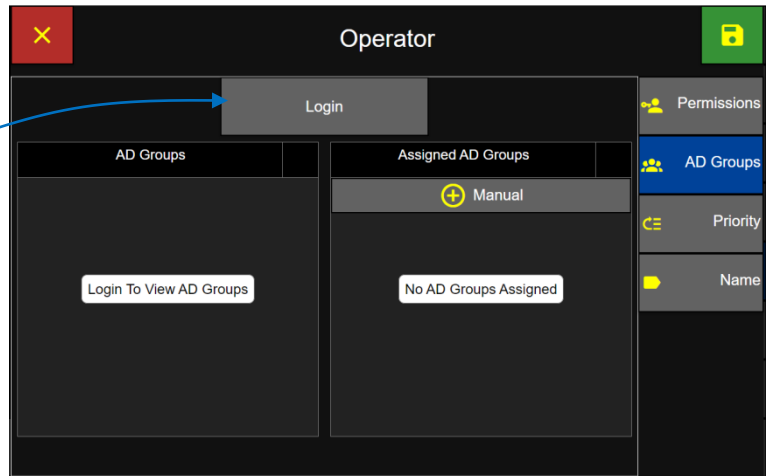

Enter the Active Directory Username and Password.

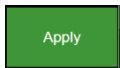

Press the Apply button.

Active Directory: Username and Password

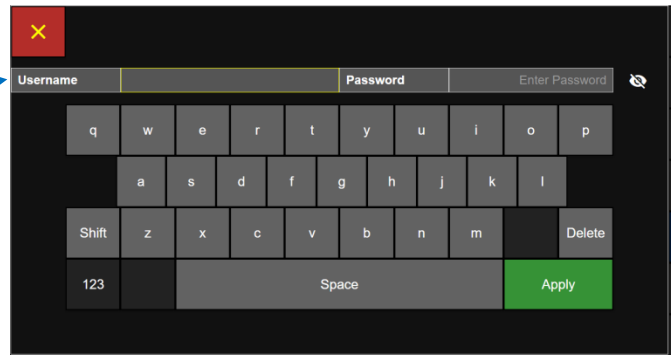

After a successful login AD Groups will display in the AD Groups list column.

Assign 1 AD Group to 1 Permission Level

Press an AD Group name and it will highlight blue and display in the "Assigned AD Groups" column.

This AD Group has now been assigned to this Permission Level.



Press the green Save button to assign the AD Group to the Permission Level.

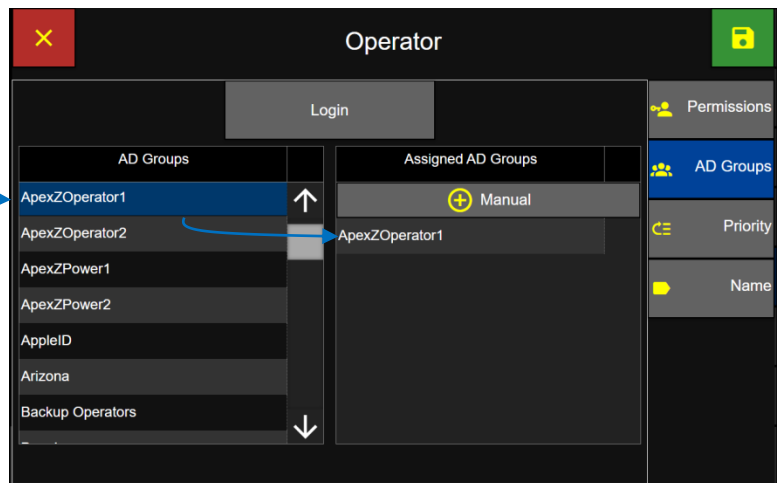

Prioritize Permission Levels

ApexZ can prioritize the permission levels created. This is because some users may appear in more than one Active Directory Group. If a user login appears in more than one Active Directory group (with different permission level settings) then the permission level assigned will be from the higher priority permission level setting on the Priority Screen.

Select the Permission Level to adjust and it will highlight blue to indicate it has been selected.

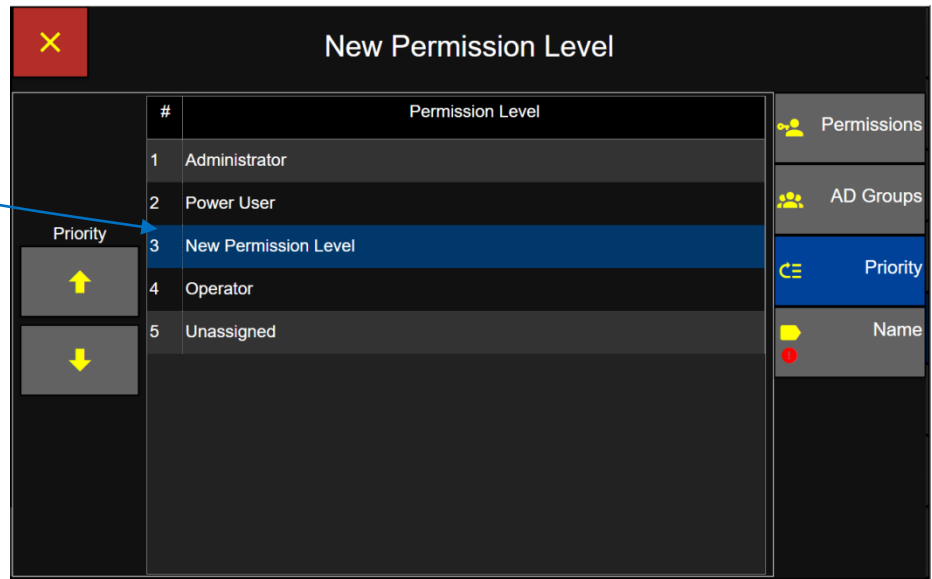

The screenshot shows the 'New Permission Level' screen. It features a close button (X) in the top left corner. The main content is a table with the following data:

#	Permission Level
1	Administrator
2	Power User
3	New Permission Level
4	Operator
5	Unassigned

To the left of the table is a 'Priority' section with an up arrow button and a down arrow button. The 'New Permission Level' row (row 3) is highlighted in blue. To the right of the table is a sidebar with several options: 'Permissions', 'AD Groups', 'Priority' (which is highlighted in blue), and 'Name'.

Press the up or down arrow buttons to move the selected permission level up or down the priority list.

Default Permission Levels

Permission levels:	Administrator <i>(Enable Locked)</i>	Power User <i>(Enable/Disable)</i>	Operator <i>(Enable/Disable)</i>	
Main Screen				✓ Enabled
Start & Stop	✓	✓	✓	
Data Screen	✓	✓	✓	
Report Screen	✓	✓	✓	
Settings Screen	✓	✓		
Data Screen	Administrator	Power User	Operator	☐ Disabled
Filter Data Records	✓	✓	✓	
Delete All Data Records	✓	✓		
Add Tag	✓	✓	✓	
Add Report	✓	✓	✓	
Export Data Records	✓	✓	✓	
Export – USB	✓	✓	✓	
Export – Print	✓	✓	✓	
Export – CIFS	✓	✓	✓	
Data Report Screen	Administrator	Power User	Operator	
Filter Data Reports	✓	✓	✓	
Delete All Data Reports	✓	✓		
Delete Data Report	✓	✓		
Export Data Reports	✓	✓	✓	
Export Report – USB	✓	✓	✓	
Export Report – Print	✓	✓	✓	
Export Report – CIFS	✓	✓	✓	
Export Audit Trails	✓	✓	✓	
Export Audit Trails – USB	✓	✓	✓	
Export Audit Trails – CIFS	✓	✓	✓	
Export Audit	✓	✓	✓	
Setting Screen	Administrator	Power User	Operator	
Sample Parameters	✓	✓		
Users	✓			
Ethernet / Wi-Fi	✓	✓		
AD/LDAP/CIFS/3 rd Party API	✓	✓		
Time	✓	✓		
Audio/Visual	✓	✓		
Options	✓	✓		
Output	✓	✓		
Configuration	✓	✓		
Service	✓	✓		

Service

From the Settings screen press the Service button to view the Maintenance, About and Service Logon tabs.

Maintenance

Press the Maintenance button to display the Firmware, Reset and Calibration functions.

Service: Maintenance Screen

Firmware Update

Insert a USB key with updated firmware into the ApexZ USB port.

Press the Update Firmware button to display the Firmware Update confirmation screen.

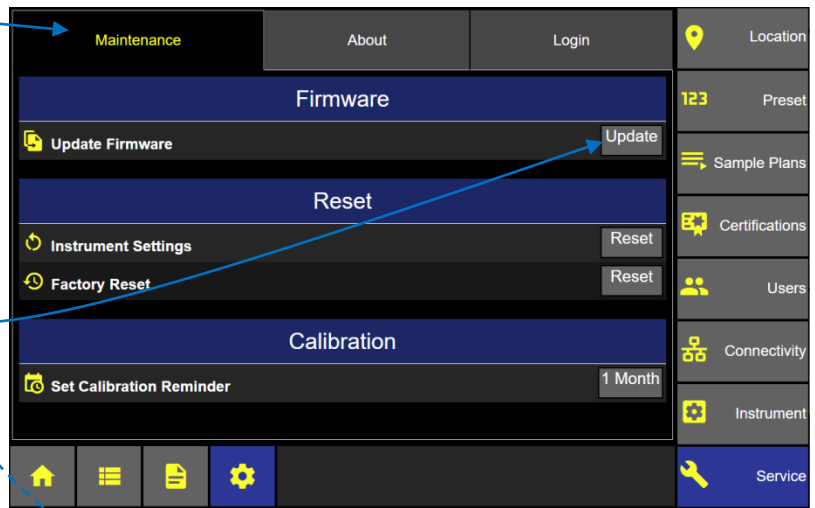

Firmware Update

Press the green check button to confirm and update the firmware on the ApexZ from the USB key.

Or press the red x button to cancel.

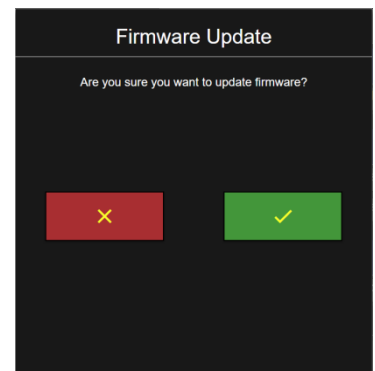

Instrument Settings Reset

Press the Instrument Settings Reset button to reset all ApexZ instrument settings.

Service: Instrument Settings Reset

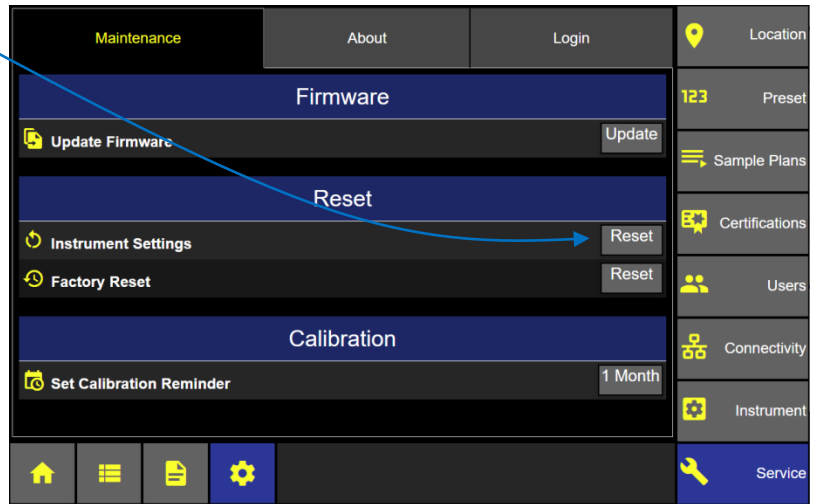

Press the green check button to confirm and reset all the instrument settings.

Settings Reset

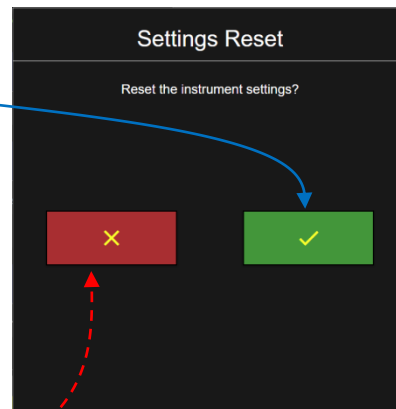

Note: Instrument settings will be reset for Time and Date, Audio/Visual, Instrument Options including output options and data format. In addition Connectivity settings for Ethernet, Wi-Fi, AD/LDAP and CIFS will be reset.

Or press the red x button to cancel.

Factory Reset

Pressing Factory Reset will DELETE all data on the ApexZ and return the instrument's configuration to its original factory default configuration. Users will be reset to the default "Administrator", "Power User" and "Operator" Permission Levels. There is no data recovery after a Factory Reset. All user created data will be deleted.

Press the Factory Reset button to prepare to reset to factory settings.

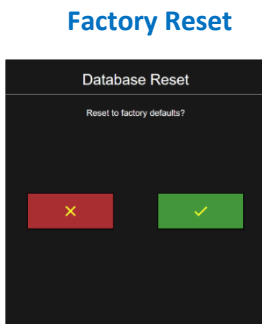

Service: Factory Reset

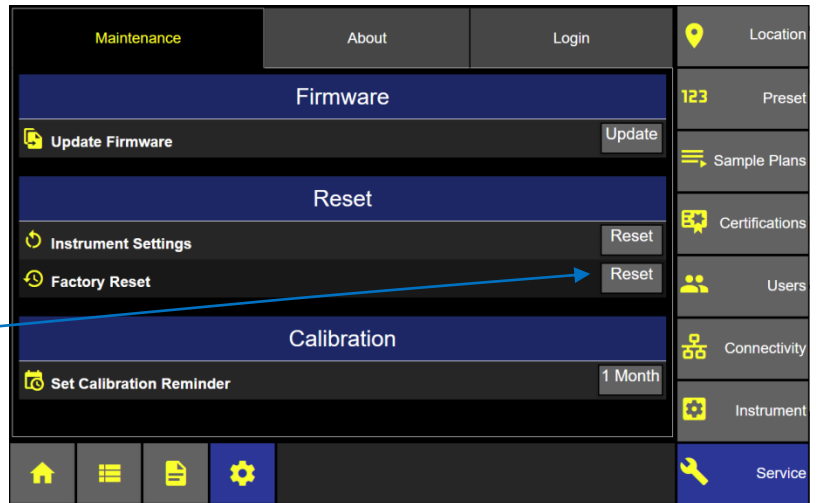

Press the green check button to confirm factory reset or press the red x button to cancel and NO factory reset.

Calibration Reminder

Press the Calibration Reminder button to select the time period for a reminder status warning before the calibration due date. An orange warning will appear in the Self-Diagnostics Status display.

- 1 Day
- 1 Week
- 2 Weeks
- 1 Month**
- Don't remind



Then press the green save button to save the reminder time period.



Or press the red x button to cancel.

Calibration Due Reminder

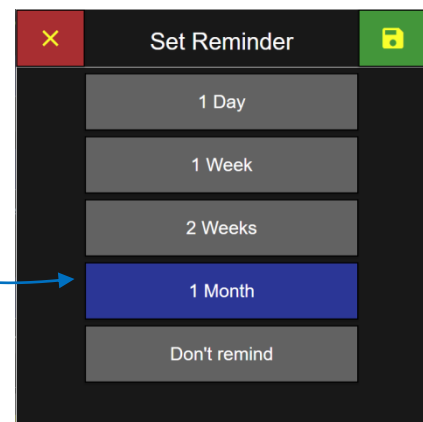

About Screen

Instrument Name

Press the Instrument Name button to enter a name for your ApexZ instrument.

Use the elevator bar to scroll down and view the Instrument identification.

- Model
- Serial #
- Sensor #
- Calibration Due Date

About Instrument

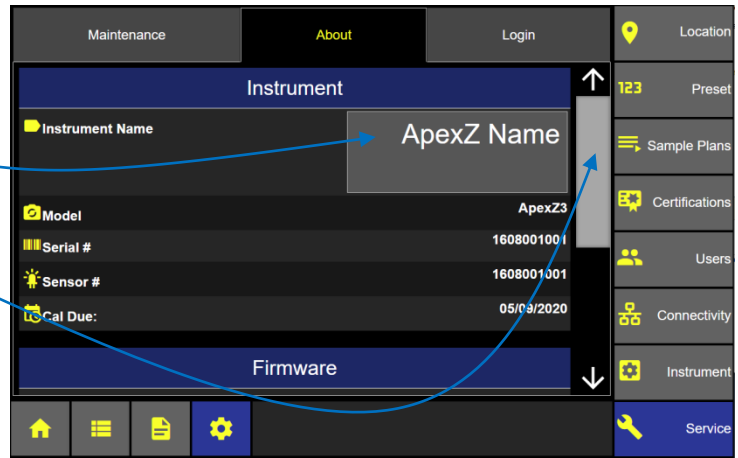

Firmware

View the ApexZ firmware.

- MEAN Firmware Version
- MAIN Firmware Version
- SIB Firmware Version
- POWER Firmware Version

About: Firmware & Open Source Libraries

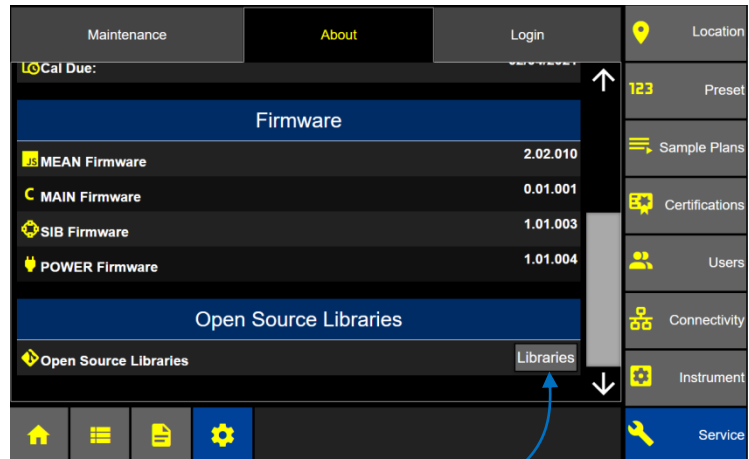

Open Source Libraries

Open Source Libraries

Press on the Libraries button to view the open source libraries used by ApexZ.

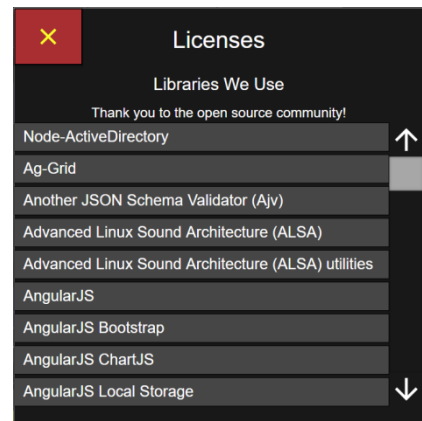

Service Login

Press the Settings then Service button to display the Service Login screen.

Note the ApexZ Passcode number and use this code to get a password from Lighthouse Service Department calibration website.

Use keypad and enter password from service department here.

Press the green Apply button.

Follow ApexZ Service Manual for instructions on how to change ApexZ service parameters.

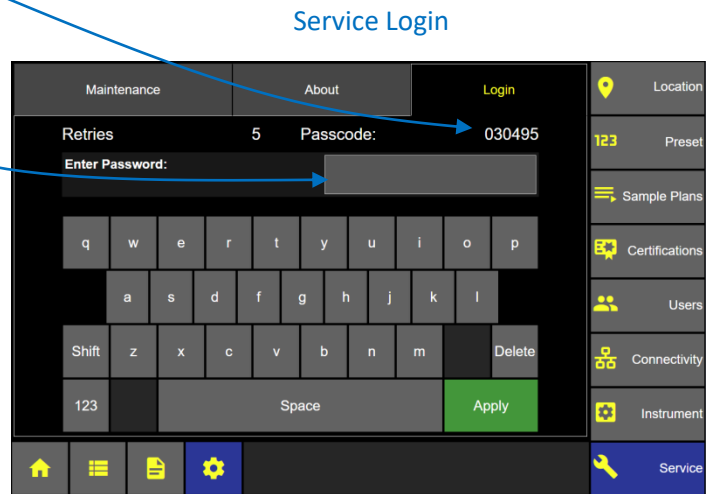

Blank Page

Calibration

Calibration – Contact Authorized Facility

ApexZ3 is factory calibrated to 1 CFM (1 cubic foot per minute).

ApexZ50 is factory calibrated to 100 LPM (100 liters per minute).

Contact a factory authorized facility to calibrate ApexZ.

Calibration – Due Date

To display calibration due date, see Section: Instruments / About.

ApexZ calibration is valid for 1 year from date of calibration.

Blank Page

Trouble Shooting

Printer:

Printer paper not advancing while printing could be the printer door is not closed.

- If the printer door is not closed then the paper will not advance but the printer will continue to print. Quickly close the printer door and printing will advance the paper properly.

Printer printing but no ink is printing on the paper could be the printer paper is loaded backwards.

- If the printer paper is load backwards the paper may still advance forward but no report data will print on the paper. After printing has stopped, simply open the printer door, remove the paper roll and reverse so that the paper feeds up from the back side of the roll and out the top of the printer. (see section: Printer Paper Installation)

Printer paper looped back into the printer housing!

- If the advancing printer paper loops back into the printer housing it may cause a paper jam.
- If this happens it is recommended to stop the printing. Simply open the printer door at any time and printing will pause. You can adjust the printer paper and close the printer door.
- Printing will resume where it left off.

Printer paper not straight

- If the printer paper is not straight or misaligned simply open the printer door and printing will stop.
- Realign the printer paper so it is feeding straight and correctly.
- Line up the left and right edges with the printer door exit slot.
- Close the printer door. If printing was interrupted then it will resume.
- See Section: Printer Paper Installation

Blank Page

Clean and Disinfect

External Enclosure

The following cleaning agents are acceptable for cleaning ApexZ polycarbonate exterior surfaces.

Spor Klenz
Bleach
Hydrogen Peroxide
IPA

Warnings

To minimize the chance of electric shock, turn off and disconnect the power adapter during sterilization.
Do not submerge ApexZ in any liquids.
Do not spray disinfectant solution directly into ApexZ enclosure.
Do not use gases to disinfect ApexZ.
Lighthouse will VOID the warranty if an unsuitable disinfectant solution damages the ApexZ instrument.

Blank Page

Terminology

Button:	Area on the touch screen the user can press and ApexZ will accept input and commands.
Enable:	Green box with yellow check mark: this button indicates enabled.
Disable:	Red box with yellow “x” mark: this button indicates disabled.
Enter with the keypad:	Touch the screen keypad with your finger and type the required input. You may need to press the green Apply button after entering text or numbers.
Inactive Button:	Button has a dark background color indicating the button is inactive and will not respond when pressed.
Press:	Touch the screen with your finger.
Select:	Touch the screen with your finger.
Toggle button:	This is a button that displays only 2 options, touch or slide to change between options.

Blank Page

Appendix A: Limited Warranty

Limitation of Warranties

A. Lighthouse Worldwide Solutions (LWS) warrants that all equipment shall be free from defects in material and workmanship under normal use for a period of two years from date of shipment to Buyer. LWS does not warrant that operation of the software will be completely uninterrupted or error free or that all program errors will be corrected. Buyer shall be responsible for determining that the equipment is suitable for Buyer's use and that such use complies with any applicable local, state, or federal law. Provided that Buyer notifies LWS in writing of any claimed defect in the equipment immediately upon discovery and any such equipment is returned to the original shipping point, transportation charges prepaid, within two years from date of shipment to Buyer and upon examination LWS determines to its satisfaction that such equipment is defective in material or workmanship, i.e. contains a defect arising out of the manufacture of the equipment and not a defect caused by other circumstances, including, but not limited to accident, misuse, unforeseeable use, neglect, alteration, improper installation, improper adjustment, improper repair, or improper testing, LWS shall, at its option, repair or replace the equipment, shipment to Buyer prepaid. LWS shall have reasonable time to make such repairs or to replace such equipment. Any repair or replacement of equipment shall not extend the period of warranty. If the Instrument is modified or in any way altered without the explicit written consent of LWS then the warranty is null and void. This warranty is limited to a period of two years, except as noted below, without regard to whether any claimed defects were discoverable or latent on the date of shipment. The length of warranty for pumps in hand held particle counters is one (1) year. Batteries and accessories with all products are warranted for one (1) year. Fuses and purge filters carry no warranty. If a third party battery is used in the product, the product warranty is null and void. If the battery is charged by a third party battery charger the battery warranty is null and void.

B. If Buyer shall fail to pay when due any portion of the purchase price or any other payment required from Buyer to LWS under this contract or otherwise, all warranties and remedies granted under this Section may, at LWS's option, be terminated.

C. THE FOREGOING WARRANTY IS EXCLUSIVE AND IN LIEU OF ALL OTHER REPRESENTATIONS, WARRANTIES AND COVENANTS, EXPRESS OR IMPLIED WITHRESPECT TO THE EQUIPMENT AND ANY DEFECTS THEREIN OF ANY NATURE WHATEVER, INCLUDING AND WITHOUT LIMITATION WARRANTIES OF MERCHANTABILITY OR FITNESS FOR A PARTICULAR PURPOSE. LWS SHALL NOT BE LIABLE FOR, AND BUYER ASSUMES ALL RISK OF, ANY ADVICE OR FAILURE TO PROVIDE ADVICE BY LWS TO BUYER REGARDING THE EQUIPMENT OR BUYERS USE OF THE SAME. UNDER NO CIRCUMSTANCES SHALL LWS BE LIABLE TO BUYER UNDER ANY TORT, NEGLIGENCE, STRICT LIABILITY, OR PRODUCT LIABILITY CLAIM AND BUYER AGREES TO WAIVE SUCH CLAIMS. LWS'S SOLE AND EXCLUSIVE LIABILITY AND BUYERS SOLE AND EXCLUSIVE REMEDY, FOR ANY ON CONFORMITY OR DEFECT IN THE PRODUCTS OR ANYTHING DONE IN CONNECTION WITH THIS CONTRACT, IN TORT, (INCLUDING NEGLIGENCE), CONTRACT, OR OTHERWISE, SHALL BE AS SET FORTH IN THE SUBSECTION A HEREOF AS LIMITED BY SUBSECTION B HEREOF. THIS EXCLUSIVE REMEDY SHALL NOT HAVE FAILED OF ITS ESSENTIAL PURPOSE (AS THAT TERM IS USED IN THE UNIFORM COMMERCIAL CODE) PROVIDED THAT THE SELLER REMAINS WILLING TO REPAIR OR REPLACE DEFECTIVE EQUIPMENT (AS DEFINED IN SUBSECTION A) WITH A COMMERCIALY REASONABLE TIME AFTER RECEIVING SUCH EQUIPMENT. BUYER SPECIFICALLY ACKNOWLEDGES THAT SELLER'S PRICE FOR THE EQUIPMENT IS BASED UPON THE LIMITATIONS OF LWS'S LIABILITY AS SET FORTH IN THIS CONTRACT.

Warranty of Repairs After Initial Two (2) Year Warranty

A. Upon expiration of the initial two-year warranty, all parts and repairs completed by an authorized Lighthouse repair technician are subject to a six (6) month warranty.

B. Other than the above, LWS makes no warranty of any kind expressed or implied, except that the products manufactured and sold by LWS shall be free from defects in materials and workmanship and shall conform to LWS's specifications; Buyer assumes all risk and liability resulting from use of the products whether used singly or in combination with other products. If instrument is modified or in any way altered without the explicit written consent of LWS, then the warranty is null and void.

C. WARRANTY REPAIRS SHALL BE COMPLETED AT THE FACTORY, BY AN AUTHORIZED SERVICE LOCATION, BY AN AUTHORIZED SERVICE TECHNICIAN, OR ON SITE AT BUYER'S FACILITY BY A LIGHTHOUSE AUTHORIZED EMPLOYEE. BUYER PAYS FREIGHT TO FACTORY; SELLER WILL PAY STANDARD RETURN FREIGHT DURING THE WARRANTY PERIOD. BUYER MAY SELECT A FASTER METHOD OF SHIPMENT AT ITS OWN EXPENSE.

Service and Support
Tel. 1-800-945-5905 (USA Toll Free)
Tel. 1-541-770-5905 (Outside of USA)
techsupport@golighthouse.com
www.golighthouse.com