

# co-mix

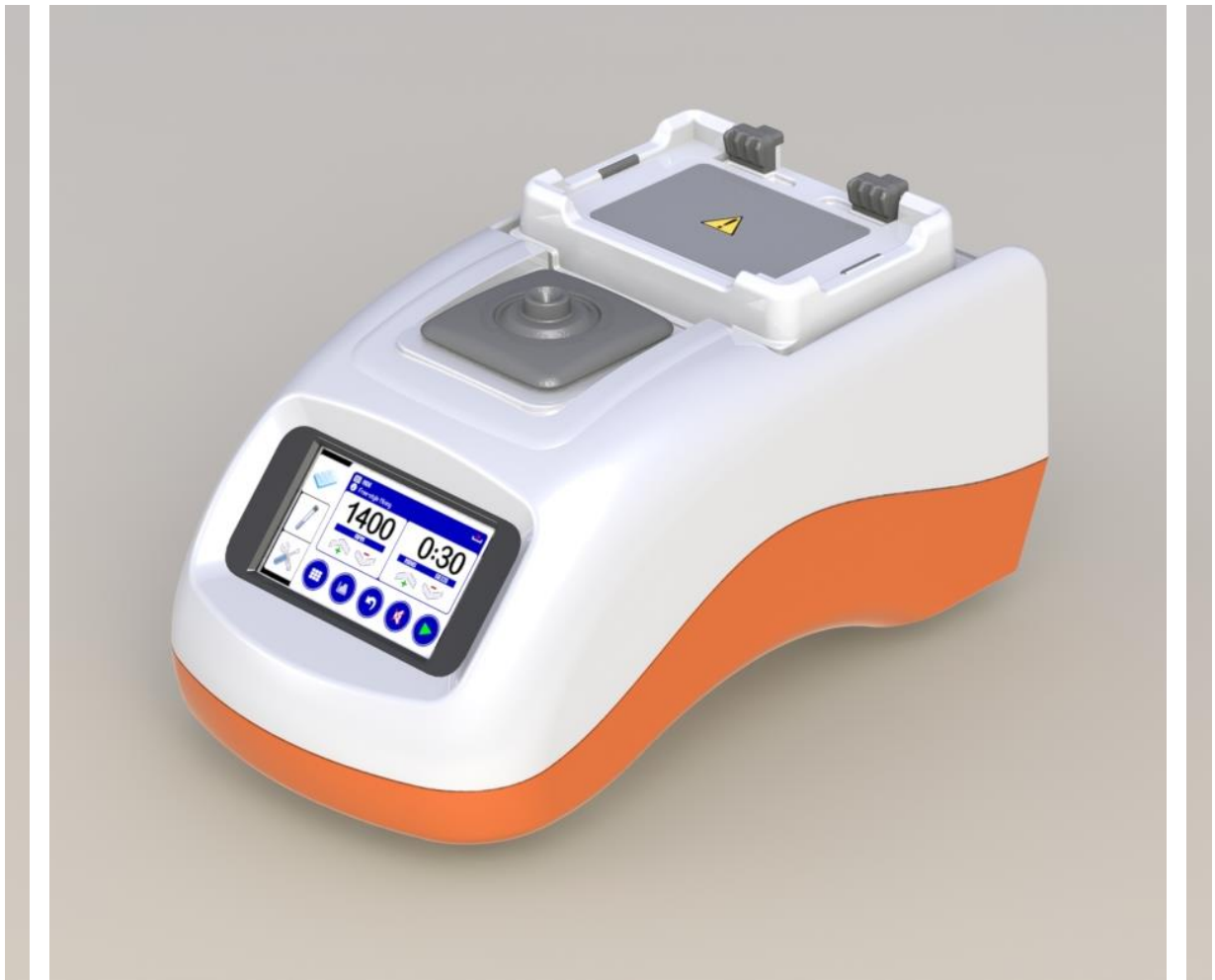

## Instructions for Use



 **This Manual Copyright © 2013-2014 ITL** 

All rights reserved. No part of this manual may be reproduced, stored in a retrieval system, or transmitted, by any means or in any form, without the prior permission of Integrated Technologies Limited (ITL).

The information contained in this manual is subject to change without notice. ITL assumes no responsibility for any errors that may appear in this or related documentation.

Document: V501001  
Revision: 3-1412

**Vitl** is the brand name for Integrated Technologies' own range of laboratory products. For further details please visit our Vitl web site.

[www.vitlproducts.com](http://www.vitlproducts.com)







All sales and technical enquiries should be addressed to:

VITL Customer Services  
Integrated Technologies Limited  
Viking House  
Ellingham Way  
Ashford  
Kent  
TN23 6NF  
United Kingdom

+44 (0)1233 638383  
[sales@vitlproducts.com](mailto:sales@vitlproducts.com)





# 1 Symbols Used in this Instruction Manual



The following advisory symbols are used in this manual.

Table 1: Advisory Symbol Meanings	
 <b>DANGER</b>	Indicates a Risk of Electric Shock which could, if not avoided, result in severe injury or death.
 <b>DANGER</b>	Indicates a Risk of Explosion which could, if not avoided, result in severe injury or death.
 <b>WARNING</b>	Indicates a hazardous situation which could, if not avoided, result in severe injury or death; or severely damage the unit.
 <b>CAUTION</b>	Indicates a hazardous situation which could, if not avoided, result in minor or moderate injury; or degrade or impair the functionality of the unit.
 <b>CAUTION</b>	Indicates a Risk of Crush hazard due to moving parts which could, if not avoided, result in minor or moderate injury.
 <b>INFO</b>	Advisory or other useful information.
	Refer to “section NN” for more details.

## 2 Safety Precautions and Limitations of Use

It is essential that all users of this equipment have fully read and understood the following safety precautions and limitations of use before installing or operating the Co-mix unit.

 <b>IMPORTANT</b> 	
 <b>WARNING</b>	<p>The protection provided by this equipment may be impaired if it is not used in a manner described in this manual.</p>
 <b>WARNING</b>	<p>It is essential that the user of this equipment is aware of the potential hazards associated with the unit and its accessories.</p> <p>All operators should be familiar with the safety precautions and warnings given in these instructions before attempting to operate the unit.</p> <p>Improper use of this unit or its accessories may impair their functionality and invalidate the manufacturer's warranty.</p>

<b>Unit Handling Precautions</b>	
 <b>CAUTION</b>	<p>Care should be taken not to drop the unit or subject it to rough physical handling, both during normal use and during transportation and storage.</p> <p>Do not use the unit if it shows any signs of damage or wear.</p>
 <b>WARNING</b>	<p>The unit should be held and supported in both hands when lifting or moving. Do not lift the unit by the mixer or vortexer.</p> <p>The base of the unit is cast from solid metal and is designed to be heavy. Care should be taken to avoid trapping fingers under unit when placing it down on a solid surface.</p>
 <b>CAUTION</b>	<p>Care should be taken not to knock the LCD display.</p> <p>Do not use excessive force when pressing the touchscreen buttons or when cleaning it.</p>

## Unit Installation and Operating Environment



**DANGER**

The Co-mix unit is designed for indoor laboratory use only.

The acceptable operating temperature range is 10°C to 38°C, with a relative humidity of 20% to 85% non-condensing, at a maximum altitude of 2000m above sea level.



**WARNING**

If the unit is stored in conditions outside of these ranges, it must be left to stand unpowered until it has acclimatised to within these environmental limits before being powered.

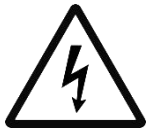

**DANGER**

Use only the AC mains power cord provided with the unit or as specified in section 11.

The unit must be connected to a suitably earthed mains supply, with appropriate earth-leakage and over-current protection.



**WARNING**

Always ensure that the mains power connector is securely inserted into the rear of the unit, and any excess power cord does not pose a potential trip or pull hazard.



**DANGER**

Do not operate the unit in any area which is, or has been, or is thought to have been exposed to explosive or flammable gases, vapours or liquids.



**WARNING**

The unit must be installed and operated on a solid, stable, vibration-free and level working surface; ensuring that the ventilation slots on the underside of the unit are not blocked.



**CAUTION**

The unit can create strong vibrations at high speeds which may cause objects positioned near to it to move.

Do not place easily movable objects near the unit; or ensure that such objects are appropriately secured.

### General Operating Precautions



**DANGER**

Ensure that the power is switched off at both the AC mains supply outlet and at the back of the unit before inserting or removing the mains power cord.

However, if a spillage occurs in or over the unit, always switch the power off and unplug the power cord at the mains supply outlet first, before attempting to deal with the spill.



**DANGER**

The unit is intended for use with aqueous solutions and suspensions only.

Never use the unit to mix any explosive, volatile or highly reactive substances or chemicals.



**WARNING**

To avoid liquid spills and possible cross-contamination of samples, only use sealed plates and closed tubes when mixing and vortexing.



**WARNING**

Injury can occur from flying plates and tubes if they are not correctly inserted, or if the maximum recommended mixing speed or total load weight is exceeded.

Always ensure that plates, adaptor blocks and tubes are correctly and securely inserted, and that plate dimensions comply with the ANSI/SBS Standards for Microplates.



**WARNING**

Serious injury can occur from improper vortexing of tubes, and tubes may be damaged, broken or destroyed.

Never vortex tubes made of glass or other fragile material.



**WARNING**

Injury or contamination can occur from sample material being expelled from the plates or tubes whilst mixing and vortexing.

Only ever mix and vortex in sealed plates and closed tubes.

Always follow prescribed laboratory procedures and use appropriate personal protective equipment (PPE, such as gloves, clothing, goggles, etc) when handling samples.

**CAUTION**

There is a possible finger crush hazard due to moving parts.

Do not remove or replace any consumables, tubes or Adaptor Blocks whilst the plate mixer is running.

Do not remove the vortexer pad when the unit is switched on.

## Unit Maintenance and Serviceability

**DANGER**

There are no user or operator serviceable parts inside the unit.

Do not remove the unit casework.

**WARNING**

Removal of the unit's casework will void the manufacturer's warranty and may expose the user to a Risk of Electric Shock resulting in serious injury or death.

**DANGER**

The externally accessible unit fuse will only blow under an extreme internal fault condition. This fuse should only be changed after the unit has been thoroughly inspected by a qualified engineer. See section 8.1 for details.

**DANGER**

Always switch off the unit and disconnect the power cord before performing any cleaning or decontamination procedure.



If liquid is spilt into or over the unit, switch off and disconnect the power from the AC mains outlet before attempting to deal with the spillage.

**CAUTION**



The use of harsh chemicals and cleaning agents may damage the unit and degrade its performance.

Always follow the cleaning and decontamination procedures specified in sections 8.2 and 8.3 of this instruction manual.

### 3 Regulatory Limitations of Use

<b>Declaration of Conformity</b>	
   <small>ELECTRICAL SAFETY E113628</small>	<p>Integrated Technologies Limited (ITL) affirm that this product fulfils the essential requirements of the Low Voltage Directive (LVD) 2006/95/EC and the EMC Directive 2004/108/EC, when installed and operated in accordance with the instructions given in this manual.</p> <p>The Co-mix unit has been type tested by TRaC Global Ltd (UKAS accredited Testing Laboratory No 0026) against the Safety and EMC Requirements listed below, and issued Certificate Nos TRAC13SAF0012 and TRA-011466-38.</p>

<b>Safety and EMC Requirements</b>	
<b>SAFETY</b>	<ul style="list-style-type: none"> <li>EN 61010-1:2010, EN 61010-2-051:2003</li> <li>UL 61010-1:2001 2nd Edition (CAN C22.2 CSA 61010-1)</li> </ul>
<b>EMC</b>	<ul style="list-style-type: none"> <li>EN 61326:2006, Class B</li> <li>FCC CFR 47 Parts 15.107 and 15.109, Class B</li> </ul>

<b>RoHS and WEEE Directive Compliance</b>	
  	<p>This product is compliant with the requirements of the RoHS2 Directive 2011/65/EU for Electrical and Electronic Equipment.</p> <p>Where applicable, the Co-mix unit should be disposed of in accordance with the European Union WEEE Directive 2002/96/EC on Waste Electrical and Electronic Equipment.</p> <p>Do not dispose of this product into unsorted municipal waste or public landfill. Please refer to section 8.5 for details of how to correctly dispose of this product.</p>

The Co-mix unit is designed and manufactured under ISO 9001 by:

**Integrated Technologies Limited**  
 Viking House, Ellingham Way, Ashford, Kent, TN23 6NF  
 United Kingdom



## 4 Unit Description

The combined mixer and vortexer unit has the following features:

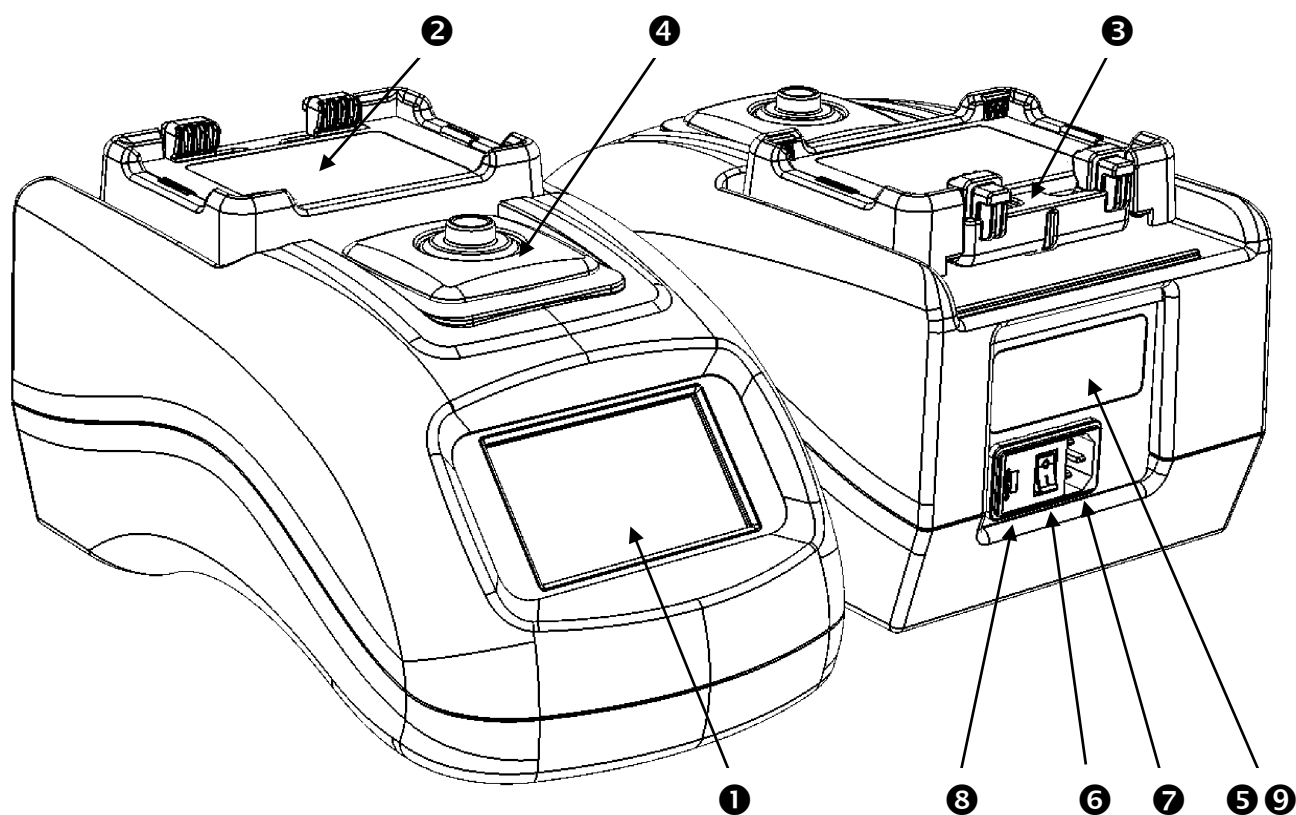

Figure 1: Front and Rear Unit Views

Table 2: Key for Figure 1 and Figure 2		
①	LCD Touchscreen User Interface	⇒ 6.1
②	Plate Mixer / Plate Holder	⇒ 6.3
③	Plate Clamping Lever	⇒ 6.3.2
④	Tube Vortexer	⇒ 6.4
⑤	Unit Label and Serial Number	⇒ 4
⑥	Mains Power Switch	⇒ 5
⑦	Mains Power Inlet	⇒ 5
⑧	External Fuse Access Cover	⇒ 8.1
⑨	Mains Power and Fuse Ratings	⇒ 11



The Co-mix has a unique automated plate clamping lever (③) which allows plates and adaptor blocks to be easily inserted and removed from the plate holder (②) without disturbing the samples.

The unit label is located at the rear and provides general ratings information:

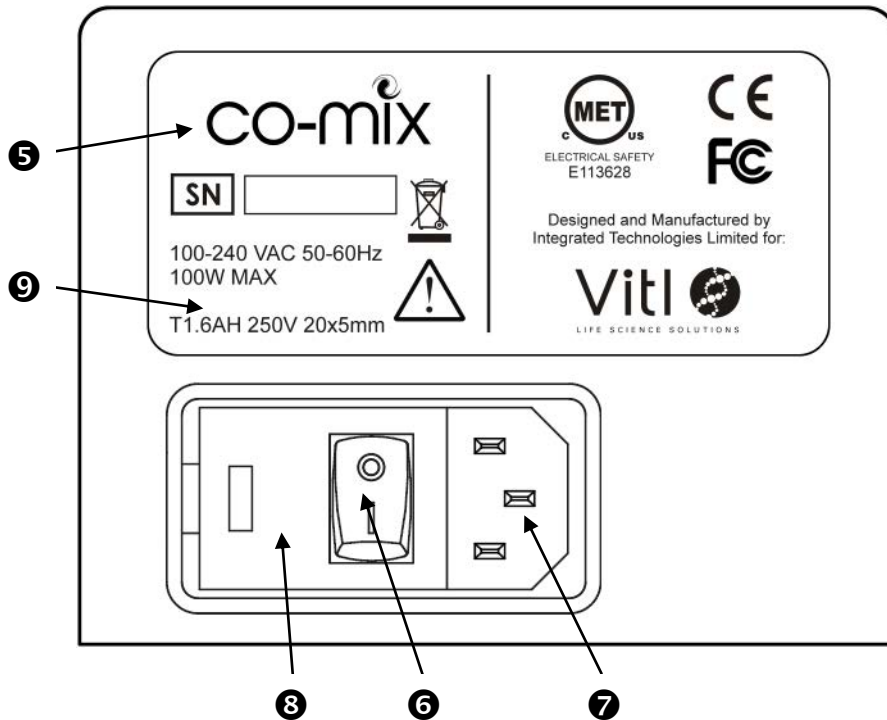
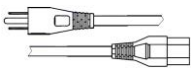
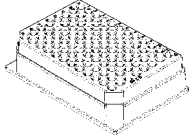
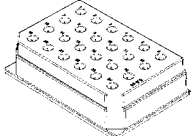
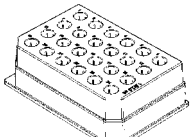

Figure 2: Unit Label and Mains Power Inlet

The unit is also supplied with the following accessories:

Table 3: Unit Accessories		
	Mains power cord (varies according to country of use)	⇒ 5 ⇒ 11
	96 well PCR plate and 0.2ml tube adaptor block	⇒ 6.3 ⇒ 6.3.3
	24 well 0.5ml tube adaptor block	⇒ 6.3 ⇒ 6.3.4
	24 well 1.5ml and 2.0ml tube adaptor block	⇒ 6.3 ⇒ 6.3.4

Other optional accessories and specialist adaptor blocks may be available on request. Please contact your distributor for details.

## 5 Unit Installation

Before installing the Co-mix unit, please check that the delivery is complete (see Table 3) and that the unit and all accessory parts are intact and free from any signs of transportation damage.



Please retain all packaging for future transportation and storage of the unit and its accessories.

The Co-mix unit should be installed in a location which meets the following requirements:

- Safe and suitable operating environment (see section 2)
- Solid, stable, vibration-free, level working surface
- At least 10cm clearance around the unit to adjacent objects and walls
- Earthed AC mains power connection (see section 11)



**WARNING**

Please also observe and abide by the **Unit Installation and Operating Environment** safety precautions and preconditions listed in section 2.

Install and test the Co-mix unit using the following procedure:

1. Place the Co-mix unit on the suitably selected working surface (as specified above), ensuring that the ventilation slots on the underside of the unit are not covered or blocked.
2. Connect the unit to the AC mains power outlet using the mains power cord supplied (see section 4).
3. Switch the mains power on at supply outlet first, and then switch the unit on using the power switch located at the rear of the unit.
4. Carry out a mixing test at the maximum required load and speed (using the free-style MIX program described in section 6.3.1) to determine if the grip between the unit and the working surface is sufficient to prevent the unit from moving.
5. If the surface grip is sufficient, then the Co-mix unit should not be moved from this installed position.

If the unit needs to be repositioned in the future, then the above installation procedure should be repeated at the new location.

## 6 Unit Operation



**WARNING**



Please ensure that you have read and fully understood all of the **Safety Precautions and Limitations of Use** listed in section 2 before attempting to operate the Co-mix unit.

### 6.1 Overview of Operating Controls

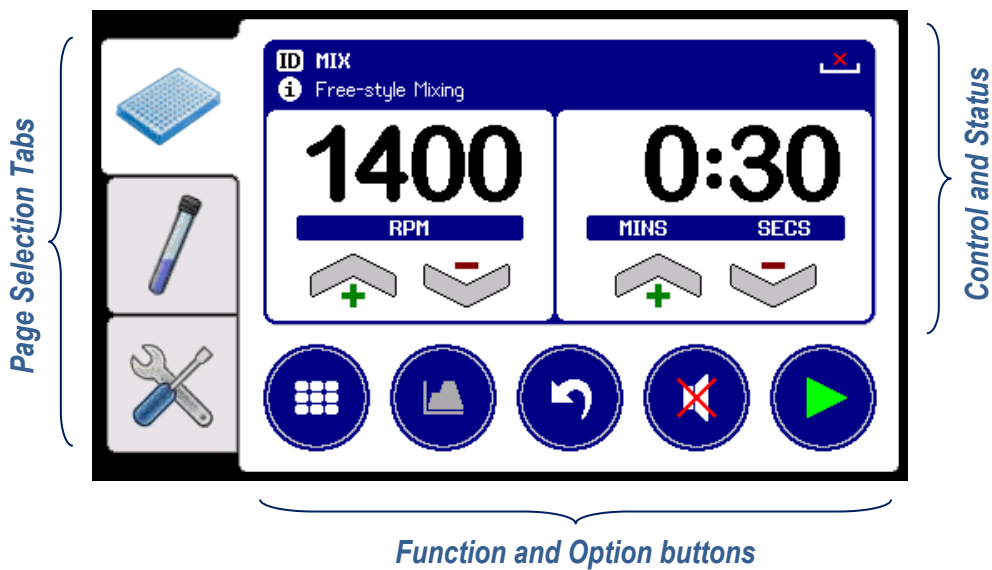
The unit's user interface consists of a colour LCD touchscreen, with page selection tabs down the left-hand side of the display and function buttons along the bottom.



The Co-mix is designed to allow simultaneous operation of both the plate mixer and tube vortexer, by providing easy mode switching using the three page selection tabs shown in Table 4.

Table 4: Page Selection Tabs		
	Plate <b>Mixer</b> control and status	⇒ 6.3
	Tube <b>Vortexer</b> control and status	⇒ 6.4
	User <b>Preferences</b> and options	⇒ 7.4

The unit can store up to 200 mixing and vortexing programs (each with different speed and time parameter settings) and is preloaded with eight commonly used mixing programs.

The program selection grid on the **Mixer** and **Vortexer** pages can store up to 100 programs each, arranged as a 3x3 scrolling grid list.

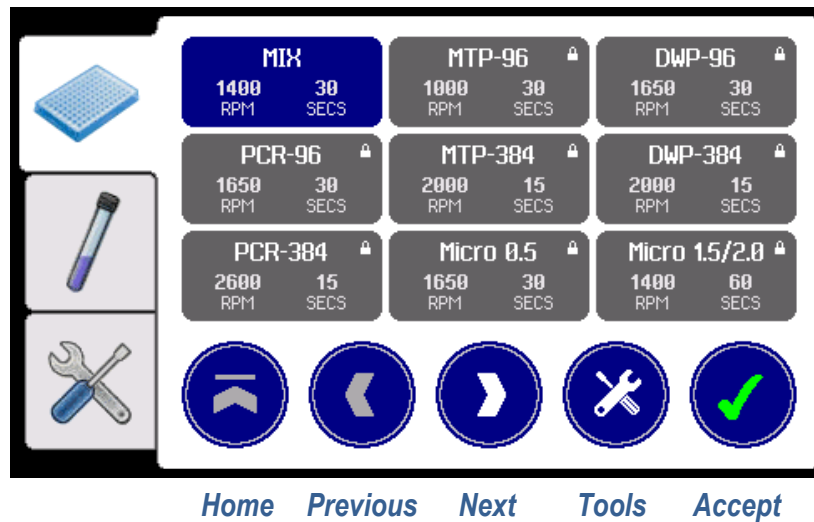

Each program grid button shows the program’s ID and the assigned speed and time parameters.

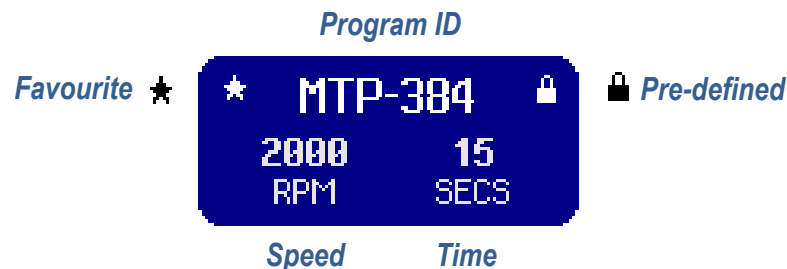

























To load a program, use the **Home** button to jump to the top of the program grid list or the **Next** and **Previous** buttons to scroll through the list to highlight the desired program, and then press the **Accept** button.

The **Tools** button allows access to advanced program set-up functions, including user-defined programs and profiled mixing programs.

























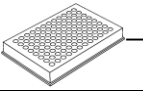

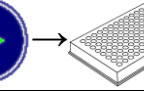











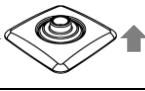























Once the unit has been fully set-up, the program set-up functions can be disabled to prevent accidental modifications. Refer to section 7.4 for details.

The user interface and controls are described in detail in sections 6.3, 6.4 and 7. Below is a quick reference guide to the main button functions.

Table 5: Button Quick Reference	
 	<b>Accept or Cancel</b> option
  	<b>Home, Previous or Next</b> program <span style="float: right;">⇒ 6.3.1</span>
	Program <b>Tools</b> menu <span style="float: right;">⇒ 7.1</span>
	<b>Exit</b> to previous menu
	Add/remove <b>Favourite</b> program <span style="float: right;">⇒ 7.1.1</span>
  	<b>New, Edit or Delete</b> program <span style="float: right;">⇒ 7.1</span>
 	Change program <b>ID</b> or <b>Info</b> <span style="float: right;">⇒ 7.1.3</span>
	Change user program <b>Adaptor</b> type <span style="float: right;">⇒ 7.1.3</span>
	<b>Unlock</b> program speed and time <span style="float: right;">⇒ 7.1.3</span>
 	<b>Increase or Decrease</b> setting <span style="float: right;">⇒ 6.3.1</span>
	Show <b>Program</b> selection grid list <span style="float: right;">⇒ 6.3.1</span>
	Mixer program <b>Profile</b> edit <span style="float: right;">⇒ 7.2</span>
 	<b>Open or Close</b> clamping mechanism <span style="float: right;">⇒ 6.3.1</span>
	<b>Mute</b> audible sounder <span style="float: right;">⇒ 6.3.1</span>
 	<b>Start and Stop</b> mixing or vortexing <span style="float: right;">⇒ 6.3.1</span>
	Vortexer <b>Restart</b> mode <span style="float: right;">⇒ 6.4.2</span>

The user preferences and set-up option buttons are detailed in section 7.4.

Table 6 provides an overview of the button presses required to perform certain common actions.

Table 6: Menu Structure and Button Presses		
Action	Button Sequence	
Load a program	 →  →  →  → 	⇒ 6.1
Load free-style program	 →  →  →  → 	⇒ 6.3.1
Fine tune free-style program	 →  →  → 	⇒ 6.3.1
Plate or Tube Mixing	 →  →  →  → 	⇒ 6.3.1
Automatic Tube Vortexing	 →  → 	⇒ 6.4.1
Manual Tube Vortexing	 →  →  →  → 	⇒ 6.4.1
Batch Tube Vortexing	 →  →  →  → 	⇒ 6.4.2
Add favourite program	 →  →  →  →  → 	⇒ 7.1.1
Create new program	 →  →  →  →  → 	⇒ 7.1.2
Edit user-defined program	 →  →  →  →  → 	⇒ 7.1.3
Change program speed and time	 →  →  →  → 	⇒ 7.1.3
Edit profiled program	 →  →  → 	⇒ 7.2
Delete user-defined program	 →  →  →  →  → 	⇒ 7.1.4

## 6.2 Unit Shutdown Procedure

After use, and before switch off the power to the unit, ensure that any plate or adaptor block has been removed from the mixer plate holder, and then put the unit into standby mode as described in section 7.4.6.

### 6.3 Mixing Plates and Tubes

The mixer is designed to handle commonly used standard sample plates and micro test tubes, as listed in Table 7.

**Table 7: Supported Plate and Tube Types**

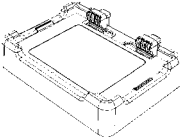
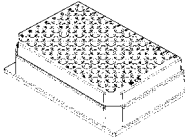
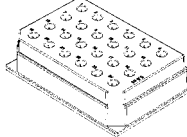
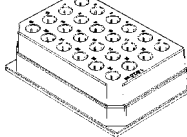
Plate or Tube Type	Plate Holder  x	Adaptor Block Type		
		PCR 0.2 ml  1	0.5 ml  2	1.5 / 2.0 ml  3
MTP 96 and 384 Well	✓ ① ②			
DWP 96 and 384 Well	✓ ① ②			
Fully-skirted PCR Plate	✓ ① ②			
Semi-skirted PCR Plate		✓ ②		
Un-skirted PCR Plate		✓ ②		
PCR 0.2 ml Tubes		✓ ②		
0.5 ml Tubes			✓ ②	
1.5 ml Tubes				✓ ②
2.0 ml Tubes				✓ ②



**CAUTION**

- ① All plates must conform to the ANSI/SBS Standard for Microplates to ensure secure positioning in the plate holder.
- ② The maximum permissible mixing speed for DWPs and Adaptor Blocks, or ② other plates over 80g, is 2000 RPM.

The Co-mix has eight pre-defined programs with recommended mixing speeds and times to support the plate and tube types listed in Table 7. Refer to section 6.3.2 and Table 8 for details.

The unit can also store over 90 user-defined mixing programs to easily facilitate the use of other specific plates, sample types and fill volumes. See section 6.3.5 for details.



Other specialist adaptor blocks may be available on request. Please contact your distributor with your specific requirements.



### 6.3.1 Mixing with Free-style Parameters

The first program in the **Mixer** selection grid list is always the free-style **MIX** program. This is a special program which allows the user to freely change the mixing speed and time parameters to suit their immediate needs.

The mixer speed can be set between 200 RPM and 3000 RPM, and the time between 5 seconds and 28 days.

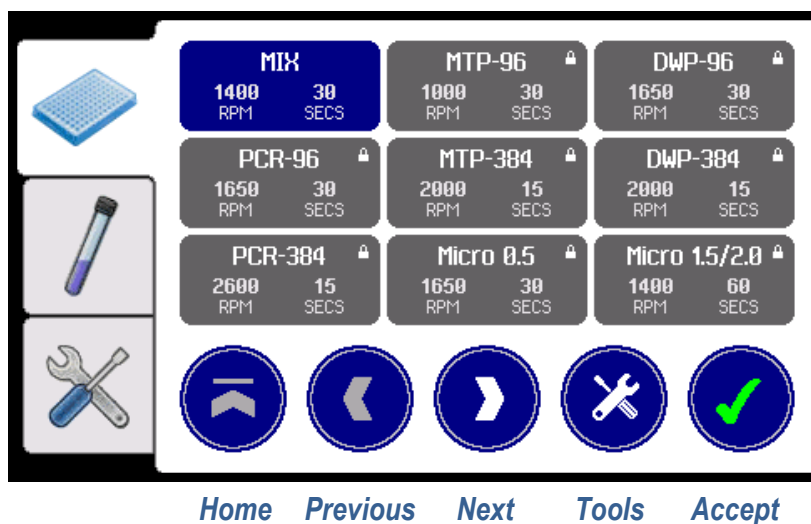

To load the MIX program, select the **Mixer** page tab, then press the **Home** button, followed by the **Accept** button.

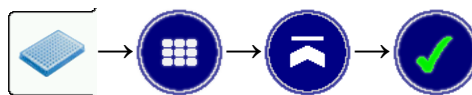

The plate clamping mechanism will automatically open, ready to accept the plate or adaptor block to be mixed.

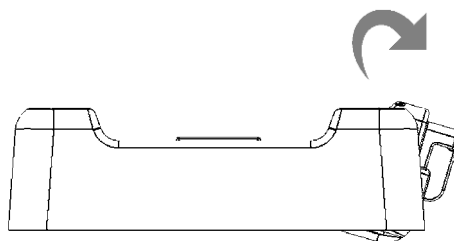

Refer to section 6.3.2 for the use of the plate adaptor blocks and associated pre-defined mixing programs.

The display now shows the current program parameters, which can be manually changed using the **Increase** and **Decrease** buttons below the speed and time values. Any changes are automatically saved in memory.

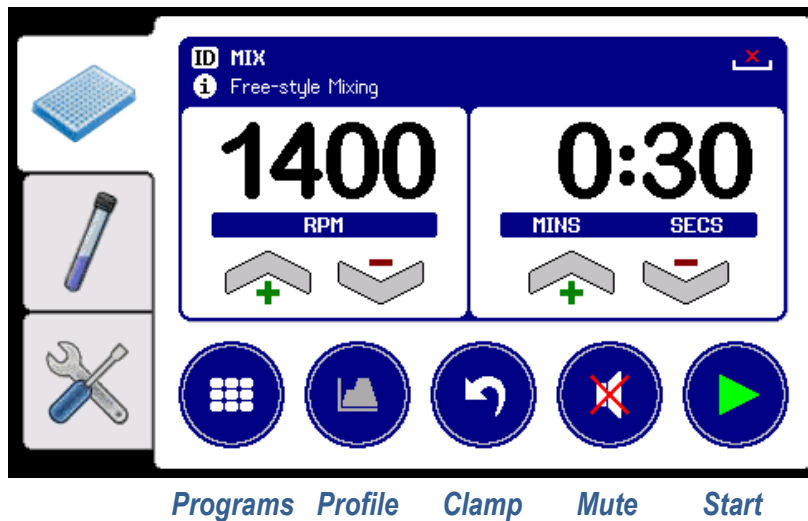

For the MIX program, the **Increase** and **Decrease** buttons are always enabled to allow the speed and time parameters to be freely changed, even when the mixer is running.

Place the plate or adaptor block vertically down into the plate holder, making sure it is sitting flat on the base of the holder.

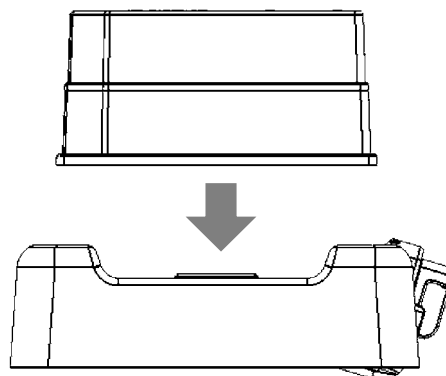

**WARNING**

Injury can occur from flying plates and tubes if they are not correctly inserted, or if the maximum recommended mixing speed or total load weight is exceeded (see section 6.3).

**DANGER**

Injury or contamination may also occur from sample material being expelled from plates or tubes whilst mixing. Always use sealed plates and closed tubes, and wear appropriate Personal Protective Equipment (PPE).

Next press the **Start** button to begin the mixing process. The plate clamping mechanism will automatically close to firmly grip the plate or adaptor block and the specified mixing program will be run.

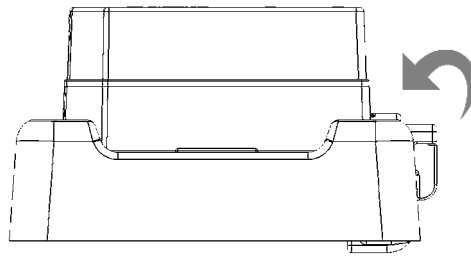

The mixing timer will now count down each second until it reaches zero, or the **Stop** button is pressed.

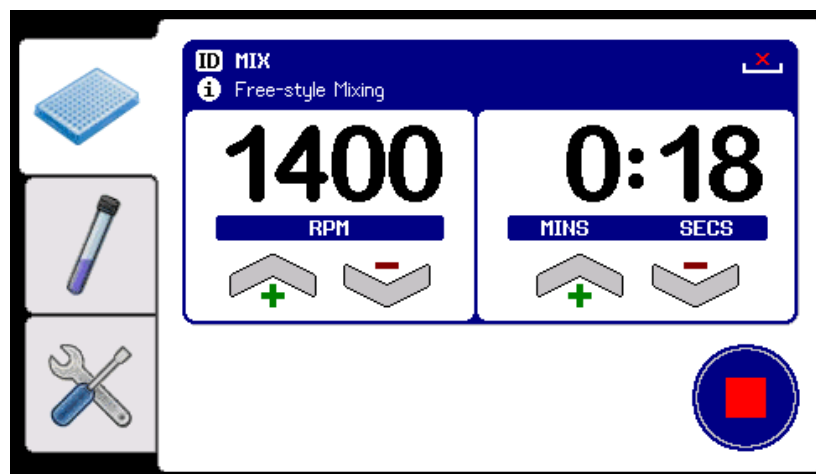

Stop

**NOTE**

The Co-mix unit has a vibration sensor which detects if the mixer becomes unstable, and automatically decreases the mixing speed (displaying the new RPM in red) to reduce the vibration. If there is still too much vibration, mixing is aborted and an E25 error displayed. See Table 18 for error code descriptions.

When mixing is complete, the unit beeps three times and the plate clamping mechanism automatically opens so that the plate or adaptor block can be easily removed without disturbing the samples.

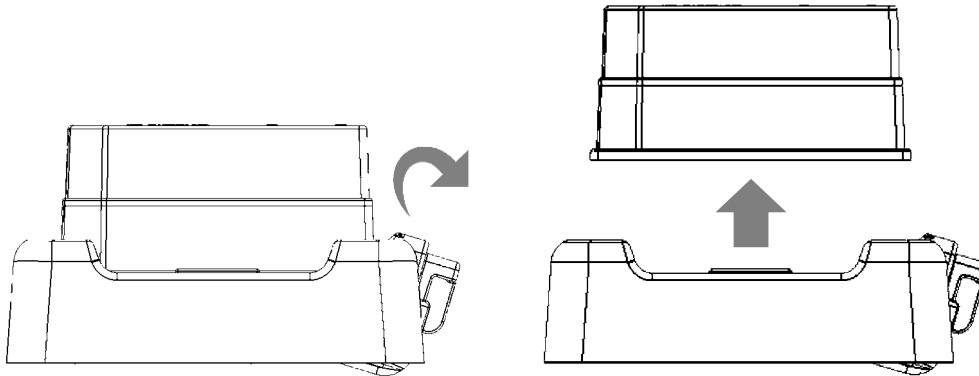

The volume of the beeps at the end of mixing process can be adjusted from the user **Preferences** page (see section 7.4.1) or temporarily disabled by pressing the **Mute** button.

The display will return to the previous screen, ready to accept the next plate to be mixed.

Pressing the **Programs** button will close the plate clamping mechanism and return to the mixer program selection screen.

The **Clamp** button can be used to manually open and close the plate clamping mechanism if required.

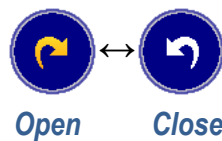



**NOTE**

If the plate clamping mechanism is left open for longer than 5 minutes, it automatically closes to conserve energy. It can be re-opened by simply pressing the **Clamp** open button.

### 6.3.2 Pre-defined Mixing Programs

The unit has eight pre-defined mixing programs which support the commonly used plates and micro test tubes listed in Table 7.

These programs are listed in Table 8, along with details of the pre-set mixing speed and time parameters, the recommended well or tube fill level and the required adaptor block type.

Table 8: Pre-defined Mixing Programs					
Program ID	Plate or Tube Type	Speed (RPM)	Time (seconds)	Fill Level	Adaptor Block
MTP-96	96 well MTP	1000	30	5 to 60%	x
DWP-96	96 well DWP	1650	30	5 to 50%	x
PCR-96	96 well PCR plate 0.2ml tubes or strips	1650	30	5 to 50%	1 
MTP-384	384 well MTP	2000	15	10 to 60%	x
DWP-384	384 well DWP	2000	15	10 to 60%	x
PCR-384	384 well PCR plate	2600	15	10 to 50%	x
Micro 0.5	0.5ml micro tubes	1650	30	5 to 50%	2 
Micro 1.5/2.0	1.5ml micro tubes 2.0ml micro tubes	1400	60	5 to 80%	3 

 Other mixing speeds and times can be selected using the free-style MIX program (see section 6.3.1) or by creating a new user-defined program (see section 6.3.5 for details).

The procedure for mixing using a pre-defined program is similar to that described in section 6.3.1 for the free-style MIX program.

First select the appropriate pre-defined program from the selection grid, and then press the **Accept** button to load it.

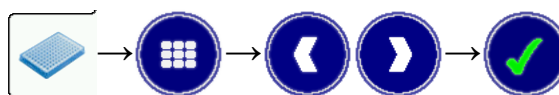

The plate clamping mechanism will automatically open to accept the plate or adaptor block to be mixed.

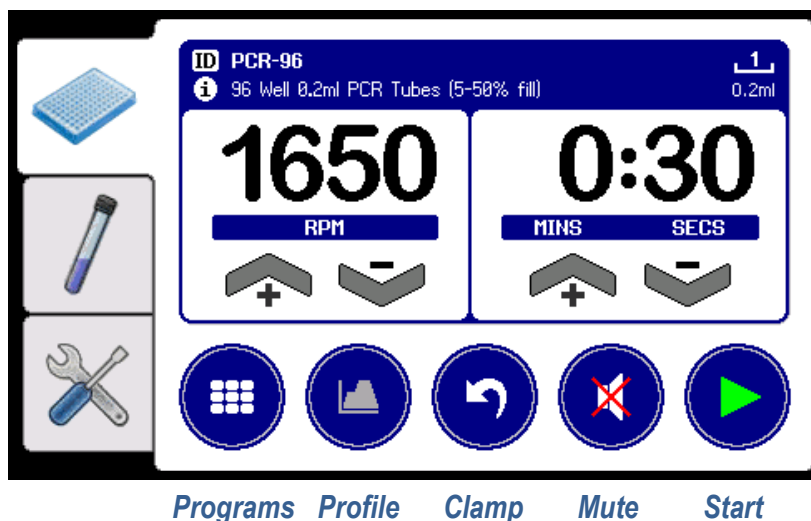

The adaptor block type is displayed in the top right-hand corner of the status area, or as 'x' if none is required. Refer to sections 6.3.3 and 6.3.4 for details relating to the use of specific adaptor blocks.



For pre-defined programs, the **Increase**, **Decrease** and **Profile** buttons are always disabled to prevent the program parameters from being modified. Refer to section 7.1.2 for details of creating user-defined variants of the pre-defined programs.

Place the plate or adaptor block into the plate holder, making sure it sitting flat on the base of the holder, and then press the **Start** button to close the clamping mechanism and begin the mixing process.

The mixing timer will count down each second until it reaches zero, or the **Stop** button is pressed.

When mixing is complete, the unit beeps and the plate clamping mechanism automatically opens so that the plate or adaptor block can be removed.

The display will return to the previous screen, ready to accept the next plate to be mixed, or press the **Programs** button to close the clamping mechanism and return to the program selection screen.

The clamping mechanism can be manually opened or closed by pressing the **Clamp** button.

### 6.3.3 Using PCR Plates in the PCR Adaptor Block (Type 1)

1. Insert the semi-skirted or un-skirted PCR plate into 96 well adaptor block (see Table 7), making sure that it is level with the top of the block and that it is securely and fully inserted.
2. Insert the adaptor block into the plate holder on the unit.

### 6.3.4 Using Micro Tubes in the Tube Adaptor Blocks (Type 1, 2 and 3)

1. Select the appropriate adaptor block for the tube being used from Table 7.
2. Insert the micro test tubes into the adaptor block, ensuring that they are securely and fully pushed down in the wells.
3. Insert the adaptor block into the plate holder on the unit.
4. After mixing, remove the adaptor block from the unit and then remove the micro tubes as required.

### 6.3.5 User-defined Mixing Programs and Profiles

The unit can store over 90 user-defined mixing programs, which can be created by copying an existing program and then changing the program ID and the speed and time parameters as required. See section 7.1.2 for details.

User-defined mixing programs can also consist of a series of individually defined program steps, each with different mixing parameters and run in succession to produce a complex profiled mixing sequence. Refer to section 7.2 for details.

## 6.4 Vortexing Tubes

The Co-mix tube vortexer is designed to operate at the same time as the plate mixer and supports the following tube types:

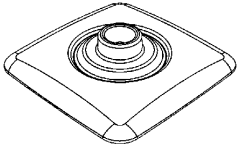
Table 9: Supported Vortexer Tube Types	
Tube Types	Vortexing Pad
	
15 ml screw top (sealed) skirted and un-skirted tubes	✓
20 ml screw top (sealed) skirted and un-skirted tubes	✓
50 ml screw top (sealed) skirted and un-skirted tubes	✓
Micro test tubes and PCR tubes (sealed)	✓
Other generic 5 ml to 100 ml screw top plastic tubes	✓
<b>NEVER USE:</b> Open topped tubes	✗ ①
<b>NEVER USE:</b> Glass tubes or other fragile materials	✗ ②
<b>NEVER USE:</b> Flasks or other flat bottomed vessels	✗ ③



**WARNING**

Serious injury can occur from improper vortexing of tubes.

- ① Never vortex open-topped tubes. Always use sealed tubes.
- ② Never vortex tubes made of glass or other fragile materials.
- ③ Not suitable for flasks or other flat bottomed vessels.

The Co-mix has no specific pre-defined vortexing programs, but instead allows up to 99 user-defined programs to be created and stored.

The vortexer speed can be set between 700 RPM and 3500 RPM, and the time between 2 seconds and 60 seconds.

### 6.4.1 General Tube Vortexing

When the unit is switched on it automatically loads the most recently used vortexing program, making it instantly ready to accept tubes.



**NOTE**

It is not necessary to have the **Vortexer** page displayed for the loaded program to run in Automatic mode - the vortexer will operate whenever the pad is depressed. See sections 6.4.2 and 7.4.5 for details of available vortexing modes.



Initially only the general purpose VORTEX program is available on the unit, which allows the user to freely change the vortexing speed and time settings.

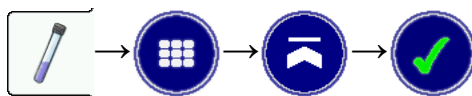

The **Vortexer** page displays the current program settings, which can be manually changed using the **Increase** and **Decrease** buttons below the speed and time values.

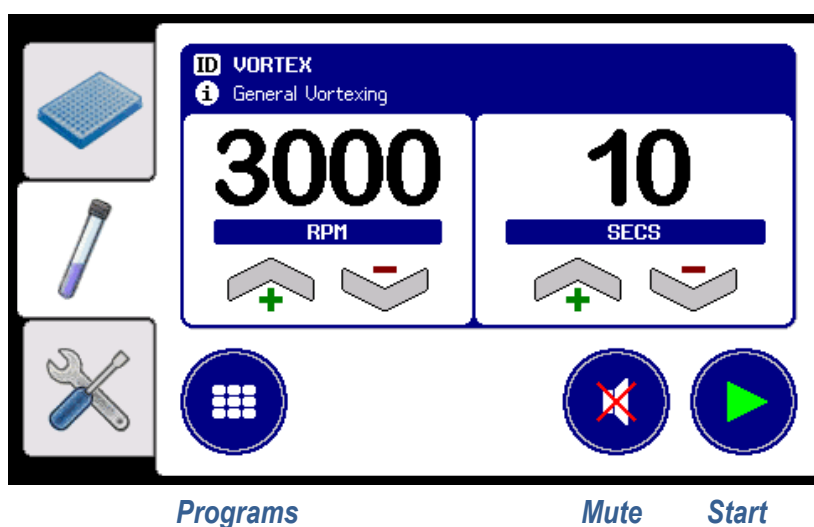

To vortex a tube, simply press the tube down onto the centre of the vortexer pad and vortexing will automatically start at the programmed speed.

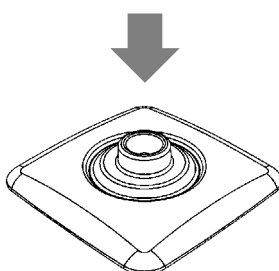

The timer will count down each second, and vortexing automatically stops when the timer reaches zero or the tube is removed from the pad.

**NOTE**

The Co-mix unit has a vibration sensor which detects if the mixer or vortexer has become unstable. If vortexing generates too much vibration it will be automatically stopped and an E35 error will be displayed. See Table 18 for error code descriptions.

Alternatively, the **Start** button can be pressed to manually set the vortexer running until either the timer reaches zero or the **Stop** button is pressed.

The speed can be adjusted whilst the vortexer is running to optimise the vortexing performance depending on the tube type, and sample type and volume being used.



When the optimum speed and time parameters have been found using the VORTEX program, a new user-defined program can be created to store these settings, and then quickly reloaded when next required. See sections 6.4.3 and 7.3 for details.

The unit clicks once to acknowledge when the tube has been pressed onto the vortexer pad, and beeps once when the programmed time has elapsed.



The volume of the click and beep at the start and end of vortexing can be adjusted from the user **Preferences** page (see section 7.4.1) or temporarily disabled by pressing the **Mute** button.

### 6.4.2 Batch Vortexing of Tubes

When processing large batches of tubes, it can be desirable to set the vortexer running and then apply each tube in rapid succession. This is done by first loading the appropriate vortexing program, then pressing the **Start** button to set the vortexer running, and then the **Restart** button.

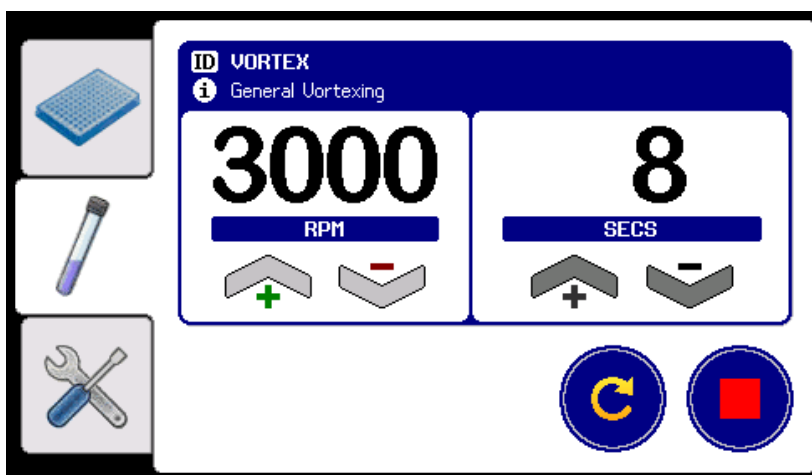
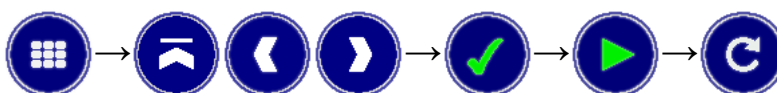

*Restart   Stop*

The **Restart** button illuminates and the timer starts counting upwards from zero instead. Now, each time a tube is pressed onto the vortexer pad (or the **Restart** button is pressed) the timer will reset back to zero.

When the programmed time is reached the unit beeps once to indicate that the tube can be removed. However, instead of stopping immediately, the vortexer runs-on for a further 5 seconds (with the time displayed in red), allowing extra time for the next tube to be placed on the vortexer.



Press the tube firmly down onto the vortexer pad to reset the timer, then relax the tube pressure so that there is still sufficient contact with the pad to maintain the vortexing action but without being unduly strenuous on the user.

**TIP**



If desired, this mode can be permanently enabled for all vortexing programs by selecting the vortexer auto-**Restart** mode in the user **Preferences** page. See section 7.4.5 for details.

### 6.4.3 User-defined Vortexing Programs

The unit can store up to 99 user-defined vortexing programs, each of which can be tailored to suit different tube types, sample solutions and fill volumes.

To define a new program, first determining the optimum vortexing parameters using the general VORTEX program (see section 6.4.1).

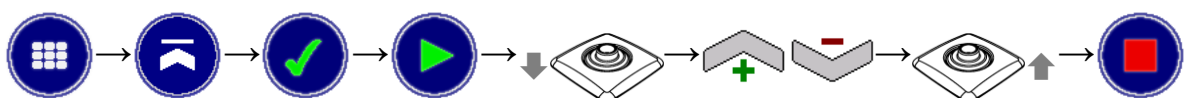

Then create a copy of these settings with a new program ID (see section 7.1.2 for details).



The new program is now ready to be used whenever next required.

## 7 Advanced Set-up Features

The Co-mix unit also provides a number of advanced features which allow the user to optimise the unit’s performance to meet their individual needs.

### 7.1 Mixer Program Tools



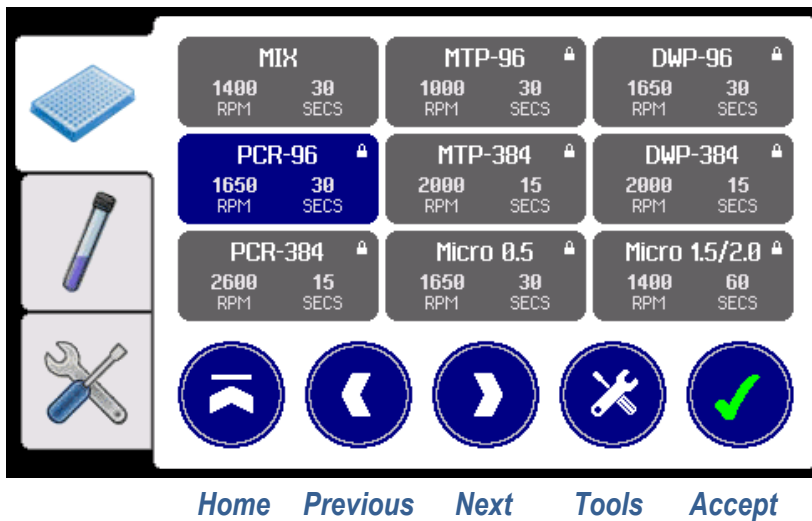

As well as the pre-defined mixing programs, the user can create variants of the existing ones. This allows new programs to be developed and optimised for the specific plate type, sample assay and fill volume being used.

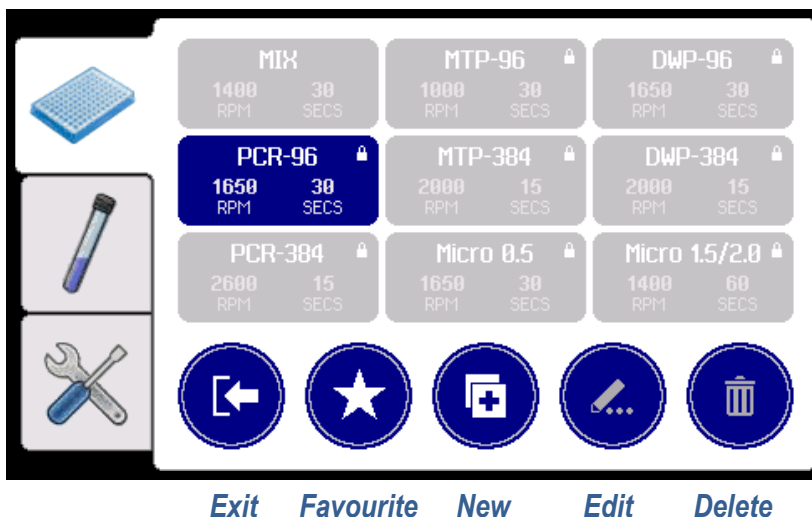

From the **Mixer** program selection screen, highlight the program to be copied or modified and then press the **Tools** button.



The tools menu options are summarised in Table 10 and explained in detail in the following sub-sections.

Table 10: Program Tools Options		
	<b>Exit</b> to program selection screen	
	Add/remove program from <b>Favourite</b> list	⇒ 7.1.1
	Create a <b>New</b> copy of the selected program	⇒ 7.1.2
	<b>Edit</b> selected program details and parameters	⇒ 7.1.3
	<b>Delete</b> the selected program	⇒ 7.1.4

### 7.1.1 Favourite Programs List

Although the programs list can hold up to 100 pre-defined and user-defined programs, typically only a small number of these will be regularly used.

Thus, to help organise the full list, preferred programs can be added to a favourites list, which always appears at the top of the program selection list.

To add a program to the favourites list, simply highlight it in the selection grid, press the **Tools** button and then the **Favourite** button. The program is marked with a ★ symbol in the top corner and moved to the top of the list.



A program can be removed from the favourites list by repeat this process.



The order of the programs within the favourites list is determined by the order in which they were created and cannot be individually rearranged.

### 7.1.2 Creating a New User-defined Program

The unit can hold up to 100 mixing programs, 91 of which can be created and defined by the user.

To add a new program, highlight an existing program from the selection list which best matches the new program requirements, then press the **Tools** button followed by the **New** button.



The **New** button is unavailable when **Protected** mode is enabled. See selection 7.4.4 for details.

This will create a new copy of the selected program and pop-up the program ID editing keyboard:

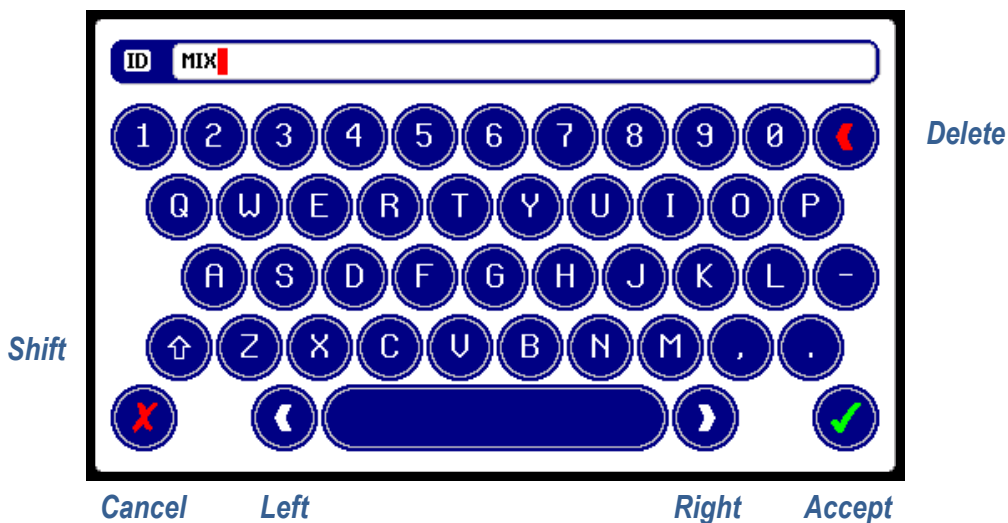

Use the QWERTY keyboard to enter a new name (ID) for the program, then press the **Accept** button.



Try to limit the program ID to about 10 characters, as longer names are displayed truncated in the program selection grid.

The new program has now been created and saved to memory, and can be further modified using the editing functions described in section 7.1.3.

### 7.1.3 Changing the Program ID, Info, Adaptor Type and Parameters

To modify an existing user-defined program, highlight the program in the selection grid, then press the **Tools** button followed by the **Edit** button.





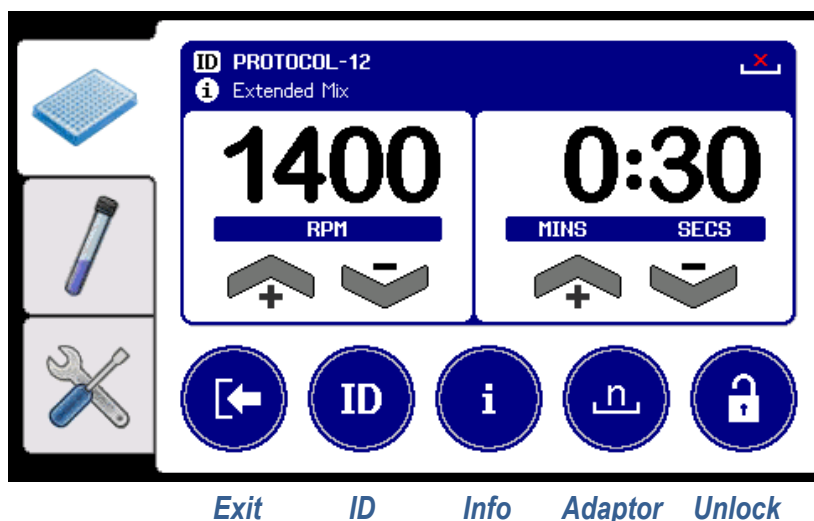

 The **Edit** button is unavailable when **Protected** mode is enabled. See selection 7.4.4 for details.

The **Edit** menu provides four top-level program editing functions.



These editing functions allow the program **ID**, **Info** text and associated **Adaptor** block type to be changed, as described in Table 11.

Table 11: Program Editing Functions		
	<b>Exit</b> program editing menu	
	Edit the program <b>ID</b> using QWERTY keyboard, which can be between 1 and 20 characters long	⇒ 7.1.2
	Edit the optional program <b>Info</b> text, which can be up to 50 characters	
	Change the <b>Adaptor</b> block type, by stepping through the block types: 'x' (none) then 1 to 9	⇒ 6.3
	<b>Unlock</b> the program to allow the speed and time settings to be changed or a profile to be defined	⇒ 7.2

Pressing the **Unlock** button enables the speed and time **Increase** and **Decrease** buttons, and the program **Profile** editor button.

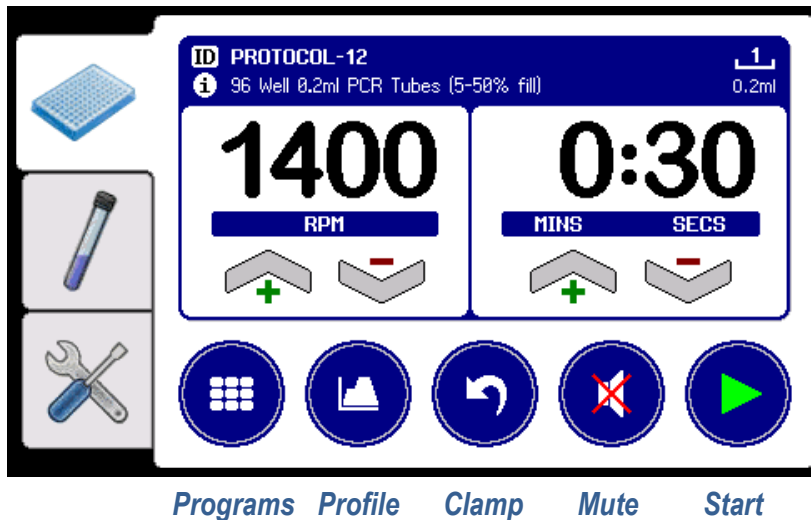

Once **Unlocked**, the **Increase** and **Decrease** buttons can be used whilst the mixer is running to fine tune the mixing performance for the particular plate type, sample solution and fill volume being used. Any changes to these parameters are automatically saved to memory for next time.

Pressing the **Profile** button brings up the advanced program profiling menu, which allows a sequence of up to 20 mixing parameter steps (speeds and times) to be defined. Refer to section 7.2 for details.

### 7.1.4 Deleting a User-defined Program

To permanently delete a user-defined program, highlight the program in the selection grid, then press the **Tools** button followed by the **Delete** button.



The **Delete** button is unavailable when **Protected** mode is enabled. See selection 7.4.4 for details.



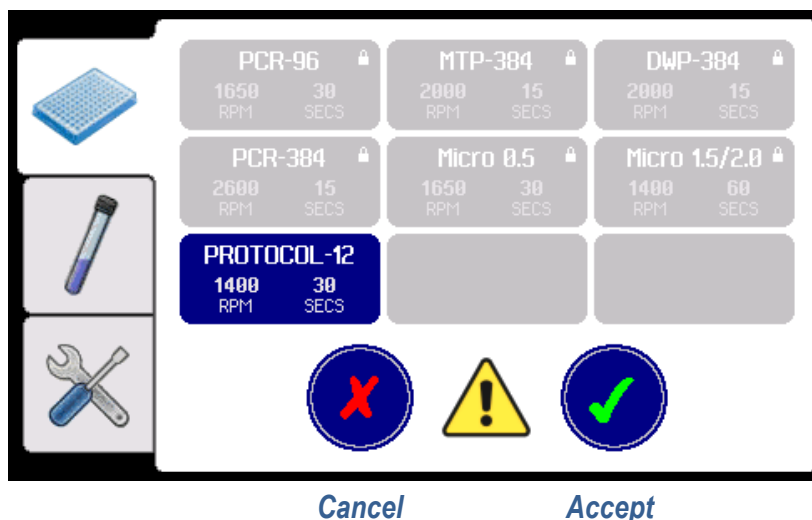

Next press the **Accept** button to confirm the deletion, or **Cancel** to exit.

## 7.2 Profiled Mixing Programs

The Co-mix can store up to 91 user-defined mixing programs, each of which can consist of a sequence of up to 20 individual mixing steps. For each mixing step, the user can specify the following parameters:

Table 12: Program Profile Step Parameters		
Parameter	Purpose	Range
RPM	Mixing speed *Automatically limited to 2000 RPM when the program specifies the use of an adopter block	200 to 3000* RPM
TIME	Mixing step duration specified in days, hours, minutes and/or seconds	5 seconds to 28 days
RAMP	Time allowed to smoothly transition between the previous speed and the new RPM value	0 to 99 seconds

Hence, an example profiled program could consist of the following three steps:

- 1) 1000 RPM, 30 seconds, 5 second ramp
- 2) 2000 RPM, 60 seconds, 10 second ramp
- 3) 1600 RPM, 5 minutes, 5 second ramp

When the program is run, the unit executes each profile step in the sequence in turn, showing the overall progress on the profile chart.

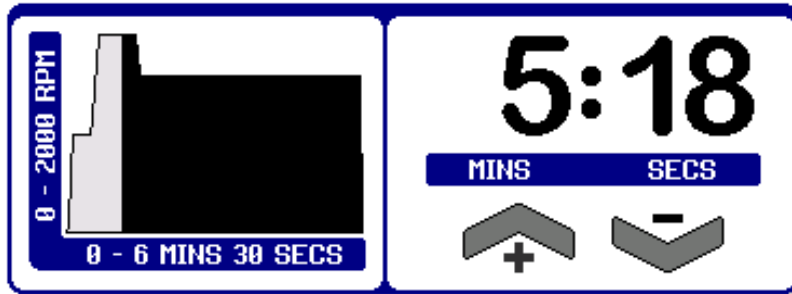

**i** For profiled programs, the speed and time cannot be adjusted using the **Increase** and **Decrease** buttons. These parameters can only be altered via the **Profile** button.

To create a new profiled program, first create a new program as described in section 7.1.2 above.

Then from the program **Tools** menu, press the **Edit** button followed by the **Unlock** button to enable the **Profile** button, and then press the **Profile** button to display the profile editing screen.



The **Profile** button accesses the profile editing menu, which consists of two sets of function buttons:

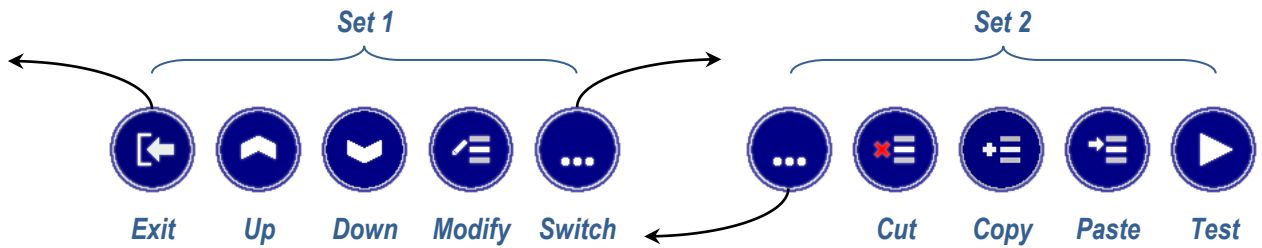

These button functions are described in Table 13.

Table 13: Program Profiling Functions		
Set 1		Exit profile editing menu
		Move profile step cursor <b>Up</b> one line
		Move profile step cursor <b>Down</b> one line
		<b>Modify</b> profile step parameters at cursor position
		<b>Switch</b> to menu functions <b>Set 2</b>
Set 2		<b>Switch</b> back to menu functions <b>Set 1</b>
		<b>Cut</b> and remove profile step at cursor position
		<b>Copy</b> profile step at cursor position
		<b>Paste</b> cut/copied profile step above cursor position
		<b>Test</b> run mixer profile step at cursor position

Press the **Modify** button to change the profile step parameters (listed in Table 12), using the numeric keypad to enter each new value followed by the **Accept** button.

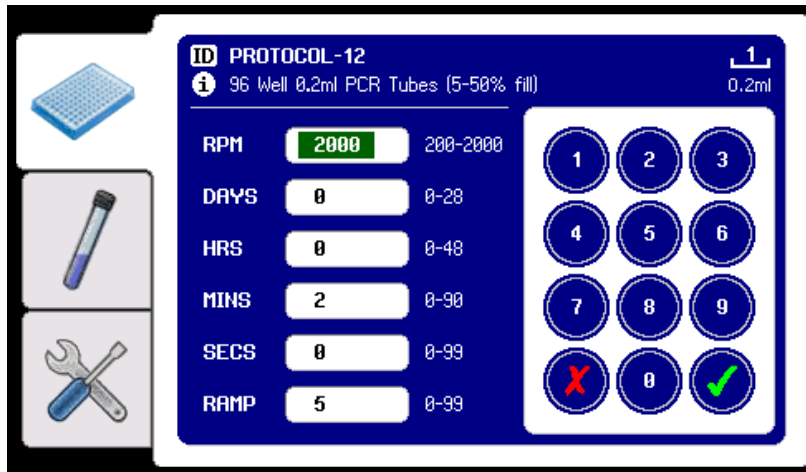

The **Accept** button is also used to skip over unmodified values. For instance, to change just the RPM, MINS and SECS values:

- 1) Enter the new RPM value followed by **Accept**
- 2) Press the **Accept** button twice (skips DAYS and HRS)
- 3) Enter the new MINS value followed by **Accept**
- 4) Enter the new SECS value followed by **Accept**
- 5) Press **Accept** again (skips RAMP)

When all six values had been accepted, the new settings are saved and the display returns to the previous profile editing screen.

To enter a new step at the end of the sequence, move the cursor **Down** to the empty “...” line and press the **Modify** button. Enter the new step parameters as required, and then press the **Accept** button until all six values have been set.

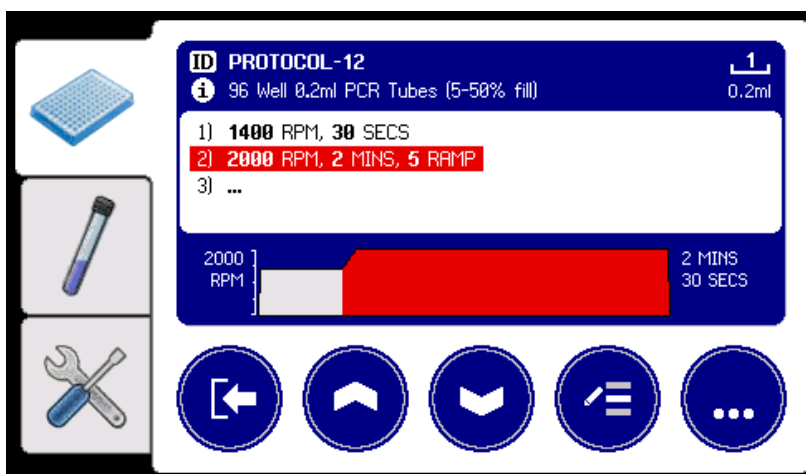

Repeat this process for up to 20 profiles steps.

The **Cut**, **Copy** and **Paste** functions can be used to delete, move and duplicate profile steps, as illustrated in Table 14.

Table 14: Profile Editing Functions	
Desired Action	Button Sequence
Modify step parameters at current cursor position	<b>Modify</b>
Add a new step at end of list	<b>Down...</b> , <b>Modify</b>
Delete step at cursor position	<b>Cut</b>
Move step at cursor to before new cursor position	<b>Cut</b> , <b>Up/Down</b> , <b>Paste</b>
Duplicate step at cursor position	<b>Copy</b> , <b>Paste</b>
Insert duplicate step before new cursor position	<b>Copy</b> , <b>Up/Down</b> , <b>Paste</b>
Insert new step before cursor position	<b>Copy</b> , <b>Paste</b> , <b>Modify</b>

### 7.3 Vortexer Program Tools

The Co-mix can store up to 99 user-defined vortexing programs, allowing specific programs to be developed and optimised for different tube types, sample solutions and fill volumes, as required.

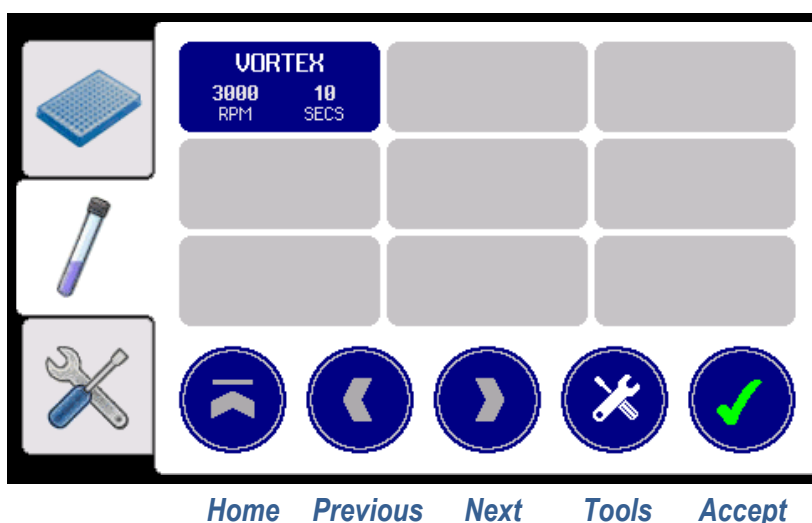

The vortexer program **Tools** menu provides the same functions as the mixer (**Favourite**, **New**, **Edit** and **Delete**), as described in section 7.1 and listed in Table 10.

The **Edit** button allows user-defined vortexing programs to be modified via the **ID**, **Info** and **Unlock** buttons, as described in section 7.1.3 and Table 11 (with the exception that there is no **Adaptor** setting for the vortexer).



















Likewise, the **Unlock** button enables the vortexing program speed and time parameters to be changed via the **Increase** and **Decrease** buttons.

## 7.4 User Preferences and Options

The user **Preferences** page provides several options for customising the unit’s behaviour, and shows the current settings state.



The available options are shown in Table 15 and described in the more detail in the following sub-sections.

Table 15: User Preferences and Options					
Beeper volume	 <i>Muted</i>	 <i>Low</i>	 <i>Medium</i>	 <i>High</i>	⇒ 7.4.1
Touchscreen button click volume	 <i>Disabled</i>	 <i>Quiet</i>	 <i>Loud</i>		⇒ 7.4.1
LCD backlight brightness level	 <i>Dim</i>	 <i>Normal</i>	 <i>Bright</i>		⇒ 7.4.2
Cooling fan operating mode	 <i>Off</i>	 <i>Automatic</i>	 <i>Continuous</i>		⇒ 7.4.3
Program set-up protection mode	 <i>Disabled</i>	 <i>Protected</i>			⇒ 7.4.4
Vortexer auto-start mode	 <i>Manual</i>	 <i>Automatic</i>	 <i>Restart</i>		⇒ 7.4.5
Standby mode	 <i>Standby</i>				⇒ 7.4.6

To change a setting, press the associated option button, then select the new value, and press the **Accept** button to save the new setting.

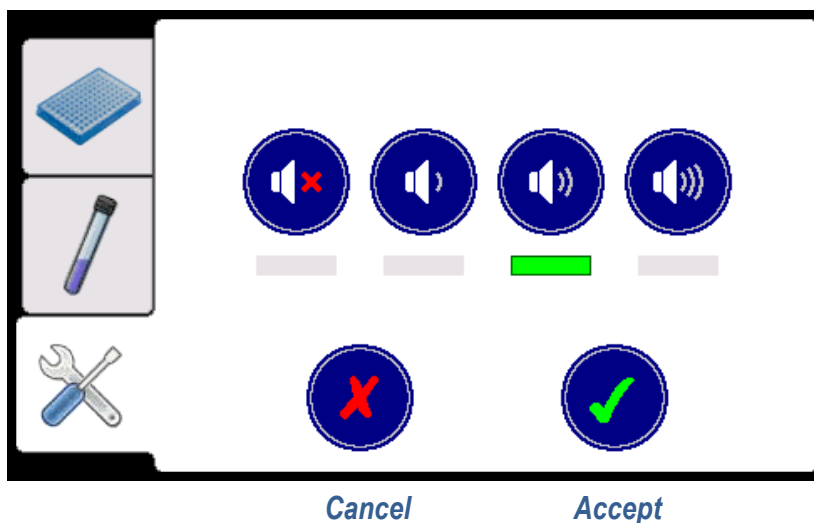

#### 7.4.1 Beeper and Button Click Volume

The beeper is sounded at the end of each mixing or vortexing operation. This volume can be adjusted to suit the ambient sound conditions, or muted.

The touchscreen button click volume can also be independently set or permanently **Disabled**.

#### 7.4.2 LCD Backlight Brightness Level

The LCD backlight brightness can be adjusted to suit different lighting conditions.

#### 7.4.3 Cooling Fan Operating Mode



The unit's internal cooling fan draws air in from around the plate holder and gently blows warm air out of the ventilation slots in the base of the unit.

It is recommended that the mode is set to **Automatic**, which operates the fan only when required. However, if the unit is being used in a temperature-controlled chamber, it may be desirable to ensure consistence airflow by setting the cooling fan to run **Continuous** or turning it **Off** completely.

#### 7.4.4 Program Set-up Protection Mode

By default, the user is able to access all features and functions of the unit. However, once the unit has been installed and fully set-up, it may be desirable to disable these programming functions to protect against accidental modification.

Enabling **Protected** mode hides the following function buttons:

Table 16: Protected Function Buttons	
	<b>New, Edit, Delete</b>
	<b>Unlock, Profile</b>
	<b>Modify, Cut, Copy, Paste</b>

To regain access to these functions, simply **Disable** protected mode again.

### 7.4.5 Vortexer Auto-start Mode

Initially the vortexer is configured to **Automatically** start when the vortexer pad is depressed, and stop when it is released. Alternatively this feature can be disabled for **Manual** start/stop operation.

If processing large batches of tubes, it may be desirable for the vortexer to run-on after the tube has been removed. This auto-**Restart** mode can be permanently enabled for all vortexer programs by using this set-up option; or temporarily using the **Restart** button described in section 6.4.2.

### 7.4.6 Standby Mode

Before turning off the unit, it is recommended to put it into standby mode by first removing any plate or adaptor block from the plate holder, and then selecting the **Standby** option and pressing the **Accept** button.

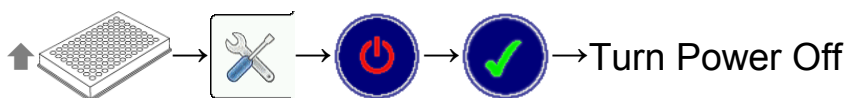

**NOTE**

When the power to the unit is switched off or disconnected, the LCD may remain illuminated for up to 5 seconds before going blank.



## 8 Maintenance and Servicing

Although the Co-mix unit does not require any scheduled servicing, the operator should regularly clean the unit and inspect it for any defects, as described in section 8.2 below.



**DANGER**

Please observe and comply with all of the **Unit Maintenance and Serviceability** precautions listed in section 2.



**WARNING**

Never removed the unit casework. There are no user or operator serviceable parts inside the unit.

Always switch off and unplug the unit before performing any cleaning or disinfecting tasks.

For technical and service related enquiries, please contact your distributor or ITL at the address given on page 2 of this manual.

### 8.1 Replacing the Unit Fuse

The unit fuse should only be replaced by a suitably qualified engineer.



**DANGER**

The unit fuse will only blow as a result of an internal unit fault. This fuse should only be changed after the unit has been thoroughly inspected by a qualified engineer, and must be replaced with the exact type specified in section 11.

Thoroughly inspect the unit for any signs of damage, loose components or liquid spillage or ingress. If in doubt, please contact ITL on the number given on page 2 of this manual.



**DANGER**

The fuse holder is removed by disconnecting the mains power cord and then using a flat bladed screwdriver to carefully pry open the fuse access cover and ease out the fuse holder.

After replacing the fuse with an identically rated fuse (see section 11), push the fuse holder firmly back into the inlet module and close the access cover.

The unit must be electrically safety tested for excess leakage current before being repowered from the mains supply.

## 8.2 Routine Cleaning and Inspection

The unit casework should be cleaned and inspected at regulator internals, or whenever contamination or spillage occurs, as follows:

1. Switch off the unit and disconnect the power cord before performing any inspection checks or cleaning.
2. Before cleaning, always inspect the unit casework, plate holder and rubber pads for any signs of wear, damage, cracks or other defects.
3. Wearing suitable PPE, clean the exterior casework using a damp cloth or cotton bud soaked with a mild detergent or disinfectant solution (such as Virkon).
4. Clean the plate holder, paying particular attention to the inner mating surfaces and the rubber pads of the holder and clamping mechanism.
5. Remove any debris or fluff from around or between the moving parts of the plate clamping mechanism.
6. Clean around the gap between the plate holder and casework to remove any build-up of debris – avoiding pushing it into the unit.
7. Clean along the spill gutter strip at the rear of the unit.
8. Clean the vortexer pad and check there is no debris accumulating between the pad and the casework. If need be, the vortexer pad can be removed for cleaning by pulling it off in an upwards motion.
9. Check that the vortexer pad is evenly and firmly pushed down.
10. Clean around the LCD fascia and touchscreen, taking care to avoid over wetting or pushing debris into bezel gap.
11. Check that the ventilation slots on the base of the unit are clear of dust and fluff build-up.
12. Check and clean the adaptor blocks. Replace the block if it becomes damaged or no longer tightly grips the tubes.



**DANGER**

After cleaning, ensure that the unit is thoroughly dry, especially around the mains power inlet, before reconnecting the power cord and switching the unit on.

Do not operate the unit if it shows any signs of damage or excessive wear.

### 8.3 Decontamination Procedure

The unit and accessories should be decontaminated using the following procedure before being stored or transported.

## Certificate of Decontamination

We respect the health and safety of our clients and employees, and request that any products or accessories being returned are decontaminated in accordance with the procedure below.

### 1. Decontamination Procedure

Thoroughly clean all outside surfaces of the product (including any accessories, power cords, manuals, packaging, etc) with a damp cloth soaked with suitable disinfectant solution (such as Virkon).

Allow to dry fully before packing.

### 2. Decontamination Declaration

Company Name: \_\_\_\_\_

Address: \_\_\_\_\_

Product Code: Co-mix

Serial Number: \_\_\_\_\_

Reason For Return: \_\_\_\_\_

Where Product Used: \_\_\_\_\_

Please tick the appropriate option(s) below:

- I certify that I have decontaminated the product as per the above procedure.  
Decontaminant Used: \_\_\_\_\_
- I certify that the product has not been exposed to any chemical or biological materials.

Title: _____	Name: _____
Signature: _____	Date: _____
Telephone: _____	Email: _____

## 8.4 Transportation and Storage

The Co-mix unit and its accessories should be thoroughly decontaminated using the procedure detailed in section 8.3 before being placed in its original packaging for transportation or storage.



**WARNING**

Refer to section 11 for the acceptable range of Storage and Transportation environmental conditions.

Always ensure that the unit and accessories are completely dry and free of any condensation before being packed.

## 8.5 Product Disposal

At end-of-life, this product must be disposed of in accordance with your local authority regulations for the disposal of potentially hazardous waste and electronic equipment.

The unit and its accessories should be decontaminated using the procedure detailed in section 8.3 before disposal or shipping.



Do not dispose of this product into unsorted municipal waste or public landfill.

Please contact your distributor (or ITL at the address on page 2 of this manual) for details of how to correctly dispose of this product.

## 9 Troubleshooting

For technical enquiries, please contact your distributor or ITL at the address given on page 2 of this manual.

<b>Table 17: Troubleshooting Tips</b>	
<b>Unit Will Not Turn On</b>	
No power → <i>Check power is switched on at wall outlet socket and rear of unit</i>	⇒ 5
Bad connection → <i>Ensure power connector fully inserted into rear of unit</i>	⇒ 5
Unit fuse blown → <i>Consult a qualified engineer</i>	⇒ 8.1
<b>Unit Spuriously Resets or Restarts Automatically</b>	
Power connector loose → <i>Ensure connector fully inserted at rear of unit</i>	⇒ 5
Supply brown-outs or black-outs → <i>Power unit from a stable AC mains supply</i>	⇒ 11
<b>Mixer Not Gripping Plate</b>	
Plate holder rubber pads dirty or worn → <i>Inspect and clean pads</i>	⇒ 8.2
<b>Mixer Will Not Run at Required Speed...</b>	
Unstable working surface → <i>Ensure installed on solid, stable, level working surface</i>	⇒ 5
Load too heavy → <i>Obverse mixing restrictions listed in Table 7 and Table 8</i>	⇒ 6.3
<b>Mixing Ineffective or Not As Expected</b>	
Mixing speed too slow → <i>Increase mixing speed for optimum performance</i>	⇒ 6.3.1
Mixing time too short → <i>Increase mixing time to ensure adequate mixing</i>	⇒ 6.3.1
Lid wetting or sample leakage → <i>Reduce mixing speed or fill volume</i>	⇒ 6.3
<b>Vortexer Does Not Operate When Pad Is Depressed</b>	
Vortexing program not loaded → <i>Select and load appropriate vortexing program</i>	⇒ 6.4
Vortexer auto-start mode not enabled → <i>Set vortexing mode to Auto or Restart</i>	⇒ 7.4.5
Vortexer pad worn or deformed → <i>Replace vortexing pad</i>	⇒ 8.2
<b>Vortexing Fails to Re-suspend Solutions</b>	
Vortexing speed too slow → <i>Increase vortexing speed for optimum performance</i>	⇒ 6.4.1
Vortexing time too short → <i>Increase vortexing time</i>	⇒ 6.4.1
Vortexer pad slippery or worn → <i>Clean or replace vortexer pad</i>	⇒ 8.2
Insufficient contact pressure between tube and vortexer pad → <i>Use Restart mode</i>	⇒ 6.4.2
Unsuitable tube type or shape → <i>Refer to Table 9 for suggested tube types</i>	⇒ 6.4
<b>Vortexer Stops Unexpectedly When Running</b>	
Insufficient contact pressure between tube and vortexer pad → <i>Use Restart mode</i>	⇒ 6.4.2
Inappropriate tube type being used → <i>Refer to Table 9 for suggested tube types</i>	⇒ 6.4
<b>Vortexer Starts Without Pad Being Depressed</b>	
Vortexer pad worn or deformed → <i>Replace vortexing pad or use Manual mode</i>	⇒ 7.4.5

If the software detects a problem with the unit, it displays the following error popup showing one of the error codes listed in Table 18.

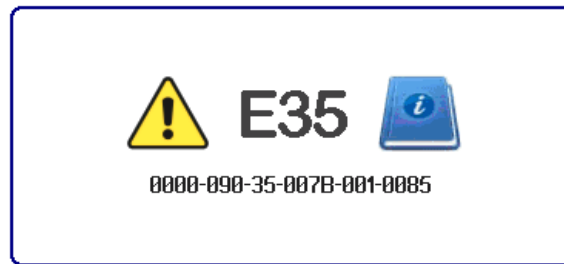

If the problem persists, please contact your distributor or ITL for assistance, quoting the error code and the 20-digit report code.

**Table 18: Unit Error Codes**

Code	Meaning	Suggested Remedy	
E10	User Preferences not set	Review option settings and adjust as required	⇒ 7.4
E20 E21 E22	Mixer mechanism fault	Contact distributor for further assistance	⇒ 8
E23 E24	Mixer overloaded or jammed	Switch off unit and inspect plate holder for obstructions	⇒ 8.2
E25	Mixing load unbalanced	Ensure unit correctly installed on solid working surface	⇒ 5
		Ensure maximum speed and load weight limits are observed	⇒ 11
E30 E31 E32	Vortexer mechanism fault	Contact distributor for further assistance	⇒ 8
E33 E34	Vortexer overloaded or jammed	Switch off unit, remove vortexer pad and inspect for any obstructions or pad wear	⇒ 8.2
E35	Vortexing too unsteady	Check unit installation and vortexer usage	⇒ 6.4
E40	Plate clamping mechanism fault	Contact distributor for further assistance	⇒ 8
All others	Internal unit fault	Contact distributor for further assistance	⇒ 8

## 10 Warranty and Returns

Integrated Technologies Limited (ITL) warrants the Co-mix product, when purchased new and installed and operated in accordance with the instructions of this manual, to be free from defects in materials and workmanship, and will repair or replace, at their discretion, any unit or accessory which exhibits such defects.

In no event will ITL be liable for any indirect, incidental or consequential damages resulting from any defect or warranty claim.

**NOTE**

Unspecified use or unauthorised modification of any part of the Co-mix unit or its accessories or the use or attachment of any adaptor or peripheral not supplied, specified or sanctioned by ITL will invalidate this warranty.

This warranty is provided to the original purchaser of the product for one year from the date of purchase.

Under the terms of this warranty, the product must be returned in its original packaging, transportation prepaid by the sender, with a copy of the Proof of Purchase and a detailed description of the problem.

**WARNING**

The product must be decontaminated using the procedure detailed in section 8.3 and a Certificate of Decontamination supplied with any return. If the product is considered too hazardous to be shipped, please contact ITL on the number given on page 2 of this manual for further instructions.

Please contact your distributor (or ITL on the number given on page 2 of this manual) to receive authorisation to return the product.

## 11 Technical Specification

### Physical Unit Properties

Dimensions (W x D x H)	190 mm x 350 mm x 200 mm
Weight (without adaptor)	7 kg

### Mains Supply

Power Cord Rating	IEC C13, 3-Core, 5A min
Inlet Module Type	IEC C14, DPST, Single Fuse
Supply Voltage Range	100 to 240 VAC $\pm 10\%$
Supply Frequency Range	50 to 60 Hz $\pm 5\%$
Power Consumption	100 W max
Fuse Rating and Size	T1.6AH 250V 20x5mm

### Operating Environment

Temperature Range	+10 to +38 °C
Relative Humidity Range	20% to 85% non-condensing
Maximum Operating Altitude	2000 m above sea-level

### Storage and Transportation

Temperature Range	-10 to +50 °C
Relative Humidity Range	20% to 95% non-condensing

### Plate Mixer Rating

Eccentric Mixing Orbit	3 mm diameter
Total Maximum Load	300 g
Speed Range (0g to 80g load)	200 to 3000 RPM
Speed Range (80g to 300g load)	200 to 2000 RPM
Time Range	5 seconds to 28 days

### Tube Vortexer Rating

Eccentric Vortexing Orbit	3 mm diameter
Speed Range	700 to 3500 RPM
Time Range	2 to 60 seconds



## 12 Glossary of Terms and Abbreviations

<b>ANSI</b>	American National Standards Institute
<b>Deepwell Plate</b>	Plate with an SBS footprint featuring 48, 96 or 384 wells with a larger volume than microplates
<b>DWP</b>	Deepwell plate
<b>EMC</b>	Electro-Magnetic Compatibility
<b>Incubate</b>	Keeping an organism, cell or cell culture at the optimum temperature for growth and development
<b>Microtiter Plate</b>	Plate with an SBS footprint featuring 24, 48, 96 or 384 wells
<b>Mixing Load</b>	All samples to be mixed located in their respective tubes or plates
<b>MTP</b>	Microtiter plate
<b>PCR</b>	Polymerase Chain Reaction
<b>Pellet</b>	A small densely packed mass. Created, for example, via the centrifugation of a suspension
<b>PPE</b>	Personal Protective Equipment
<b>Re-suspending</b>	Dissolving a pellet by Vortexing in a liquid with the material being redistributed in the liquid
<b>RPM</b>	Revolutions Per Minute
<b>SBS</b>	Society for Bio molecular Screening
<b>Semi-skirted PCR Plate</b>	PCR plate with an outer surrounding half edge
<b>Skirted PCR Plate</b>	PCR plate with an outer surrounding edge
<b>Un-skirted PCR Plate</b>	PCR plate without an outer surrounding edge
<b>Vortexing</b>	Strong whirling or spinning flow of liquid by manually pressing a tube onto the Vortexing pad
<b>Well</b>	A single cavity in a Microtiter plate, PCR plate or Deepwell plate

## Contents

1	☉ Symbols Used in this Instruction Manual .....	3
2	☉ Safety Precautions and Limitations of Use .....	4
3	☉ Regulatory Limitations of Use .....	8
4	☉ Unit Description .....	9
5	☉ Unit Installation .....	11
6	☉ Unit Operation .....	12
6.1	☉ Overview of Operating Controls .....	12
6.2	☉ Unit Shutdown Procedure .....	15
6.3	☉ Mixing Plates and Tubes .....	16
6.3.1	☉ Mixing with Free-style Parameters .....	17
6.3.2	☉ Pre-defined Mixing Programs .....	21
6.3.3	☉ Using PCR Plates in the PCR Adaptor Block (Type 1) .....	23
6.3.4	☉ Using Micro Tubes in the Tube Adaptor Blocks (Type 1, 2 and 3) .....	23
6.3.5	☉ User-defined Mixing Programs .....	23
6.4	☉ Vortexing Tubes .....	24
6.4.1	☉ General Tube Vortexing .....	24
6.4.2	☉ Batch Vortexing of Tubes .....	26
6.4.3	☉ User-defined Vortexing Programs .....	27
7	☉ Advanced Set-up Features .....	28
7.1	☉ Mixer Program Tools .....	28
7.1.1	☉ Favourite Programs List .....	29
7.1.2	☉ Creating a New User-defined Program .....	30
7.1.3	☉ Changing the Program ID, Info, Adaptor Type and Parameters .....	31
7.1.4	☉ Deleting a User-defined Program .....	32
7.2	☉ Profiled Mixing Programs .....	33
7.3	☉ Vortexer Program Tools .....	37
7.4	☉ User Preferences and Options .....	38
7.4.1	☉ Beeper and Button Click Volume .....	39
7.4.2	☉ LCD Backlight Brightness Level .....	39
7.4.3	☉ Cooling Fan Operating Mode .....	39
7.4.4	☉ Program Set-up Protection Mode .....	39
7.4.5	☉ Vortexer Auto-start Mode .....	40
7.4.6	☉ Standby Mode .....	40
8	☉ Maintenance and Servicing .....	41
8.1	☉ Replacing the Unit Fuse .....	41
8.2	☉ Routine Cleaning and Inspection .....	42
8.3	☉ Decontamination Procedure .....	43
8.4	☉ Transportation and Storage .....	44
8.5	☉ Product Disposal .....	44
9	☉ Troubleshooting .....	45
10	☉ Warranty and Returns .....	47
11	☉ Technical Specification .....	48
12	☉ Glossary of Terms and Abbreviations .....	49

---

## **Figures**

Figure 1: Front and Rear Unit Views .....	9
Figure 2: Unit Label and Mains Power Inlet.....	10

## **Tables**

Table 1: Advisory Symbol Meanings.....	3
Table 2: Key for Figure 1 and Figure 2 .....	9
Table 3: Unit Accessories .....	10
Table 4: Page Selection Tabs.....	12
Table 5: Button Quick Reference.....	14
Table 6: Menu Structure and Button Presses.....	15
Table 7: Supported Plate and Tube Types .....	16
Table 8: Pre-defined Mixing Programs .....	21
Table 9: Supported Vortexer Tube Types.....	24
Table 10: Program Tools Options.....	29
Table 11: Program Editing Functions .....	31
Table 12: Program Profile Step Parameters.....	33
Table 13: Program Profiling Functions .....	35
Table 14: Profile Editing Functions .....	37
Table 15: User Preferences and Options .....	38
Table 16: Protected Function Buttons .....	40
Table 17: Troubleshooting Tips .....	45
Table 18: Unit Error Codes .....	46