

Operating Instructions
Original Operating Instructions

Cubis®

MCA Models
High-capacity Precision Balances



Contents

1 About these Instructions	5	5 Installation	32
1.1 Scope.....	5	5.1 Scope of Delivery.....	32
1.2 Symbols Used.....	5	5.2 Selecting an Installation Site.....	32
1.2.1 Warnings in Operating Instructions.....	5	5.3 Unpacking the Device.....	33
1.2.2 Other Symbols.....	5	5.4 Removing the Control Unit.....	33
1.3 Target Groups.....	6	5.5 Connecting the Ethernet Cable.....	34
2 Safety Instructions	7	5.6 Preparing Below-balance Weighing.....	34
2.1 Intended Use.....	7	5.7 Positioning the Weighing Pan and Associated Components.....	36
2.2 Personnel Qualification.....	7	5.8 Acclimatization.....	36
2.3 Proper Working Order of the Device.....	8	6 Getting Started	37
2.4 Symbols on the Device.....	8	6.1 Installing the AC Adapter.....	37
2.5 Electrical Equipment.....	8	6.2 Connecting the Power Supply.....	37
2.5.1 Damage to the Electrical Equipment of the Device.....	8	7 System Settings	38
2.5.2 Working on the Electrical Equipment of the Device.....	8	7.1 Performing System Settings.....	38
2.5.3 AC Adapter and Power Supply Cable.....	8	7.2 Switching Off the isoCAL Function.....	38
2.6 Conduct in an Emergency.....	8	7.3 Assigning a Password.....	38
2.7 Accessories, Consumables, and Spare Parts.....	9	7.4 Parameter List.....	39
2.8 Personal Protective Equipment.....	9	7.4.1 Parameters in the "User Configuration" Menu.....	39
2.9 Glass Breakage.....	9	7.4.2 Parameters in the "Profile Management" Menu.....	39
3 Device Description	10	7.4.3 Parameters in the "Device Settings" Menu..	42
3.1 Device Overview.....	10	7.4.4 Parameters in the "Connections" Menu.....	45
3.2 Weighing Pan and Associated Components.....	11	8 Operation	50
3.3 Connections and Components on the Weighing Module.....	12	8.1 Switching the Device On and Off.....	50
3.4 Connections on the Control Unit.....	12	8.2 Logging Users In and Out.....	50
3.5 Conformity-assessed Devices.....	13	8.3 Leveling the Device.....	51
3.6 Symbols on the Device.....	13	8.3.1 Level Device with Inclination Sensor.....	51
4 Operating Concept	14	8.4 Activating Applications and Adding a Task.....	51
4.1 Operating Elements in the Main Menu.....	14	8.4.1 Activating Applications.....	51
4.2 Operating Elements in Task Management.....	15	8.4.2 Adding an Application to a Task.....	52
4.3 Operating Elements in the Weighing Display.....	16	8.5 Adding Print and Weighing Profiles to a Task.....	52
4.4 Advanced Operator Guidance.....	17	8.6 Preparing Weighings.....	52
4.5 Messages.....	18	8.7 Weighing.....	53
4.6 Status Center.....	19	8.8 Overview of Calibration, Adjustment, and Linearization.....	53
4.7 Keypad.....	20	8.9 Adjusting with the isoCAL Function.....	54
4.8 Status Display of the Buttons.....	20	8.10 Internally Calibrating and Adjusting the Device....	55
4.9 Buttons in the Operating Display.....	21	8.11 Weighing and Printing with ID Marking.....	55
4.9.1 Buttons for Navigation or Organization in Displays.....	21	8.11.1 Saving Values for Printouts.....	55
4.9.2 Buttons for Editing or Managing Entries....	22	8.11.2 Marking Saved Values as Invalid.....	56
4.9.3 Weighing and Print Function Buttons.....	23	8.11.3 Marking Saved Values as Valid.....	56
4.10 Displays in the Operating Display.....	24	8.11.4 Printing Saved Values.....	56
4.11 User Management.....	25	8.11.5 Exiting the Task.....	56
4.11.1 User Profiles.....	25	8.12 Viewing the Alibi Memory.....	57
4.11.2 User Login.....	25	8.13 Running Applications (Examples).....	57
4.12 Profile Management.....	25	8.13.1 Executing the "Toggle Between Weight Units" Function.....	57
4.13 Applications and Tasks.....	25	8.13.2 Running the "Statistics" Application.....	58
4.14 Menu Structure.....	26		
4.14.1 Main Menu.....	26		
4.14.2 "Settings" Menu.....	26		
4.15 Navigating the Menus.....	30		

9	Cleaning and Maintenance	59
9.1	Preparing the Device	59
9.2	Cleaning the Device	59
9.3	Assembling and Connecting the Device	60
9.4	Maintenance Schedule	60
9.5	Performing a Software Update	60
9.6	Performing a QAPP Center Update	61
10	Malfunctions	62
10.1	Warning Messages	62
10.2	Troubleshooting	62
11	Decommissioning	63
11.1	Decommissioning the Device	63
12	Transport	63
12.1	Transporting the Device	63
13	Storage and Shipping	64
13.1	Storage	64
13.2	Returning Device and Parts	64
14	Disposal	65
14.1	Information on Decontamination	65
14.2	Disposing of Device and Parts	65
14.2.1	Information on Disposal	65
14.2.2	Disposal	65
15	Technical Data	66
15.1	Dimensions and Weight	66
15.1.1	High-capacity Precision Balance	66
15.2	Power Supply	66
15.2.1	Device	66
15.2.2	Power Supply Unit	66
15.2.3	Safety of Electrical Equipment	67
15.2.4	Electromagnetic Compatibility	67
15.3	Materials	67
15.4	Integrated Clock	67
15.5	Backup Battery	67
15.6	Ambient Conditions	68
15.6.1	Installation Site	68
15.6.2	Ambient temperature for the isoCAL function	68
15.6.3	Protection Class	68
15.7	Metrological Data	69
15.7.1	Models MCA32202P MCA70201S MCA50201S MCA36201S	69
15.7.2	Models MCA36201P MCA20201S MCA11201S MCA70200S MCA36200S	70
15.8	Recommended Calibration Weight	71
15.9	isoCAL Function	71
15.9.1	Models MCA32202P MCA70201S MCA50201S MCA70200S	71
15.9.2	Models MCA36201S MCA36201P MCA20201S MCA11201S MCA36200S	71
15.10	Alibi Memory	72
15.11	Interfaces	72
15.11.1	Specifications for the COM-RS232 Interface	72
15.11.2	Specifications for the USB-A Interface	72
15.11.3	Specifications for the USB-B Interface	72
16	Accessories	73
16.1	Accessories	73
16.1.1	Printers and Communication	73
16.1.2	Displays and Input/Output Elements	73
16.1.3	Weighing Tables	74
16.1.4	Weighing Accessories	74
17	Sartorius Service	75
18	Conformity and Certificates	75
18.1	EU Declaration of Conformity	75
18.2	Certificate of Compliance	77
18.3	FCC Supplier's Declaration of Conformity	79

1 About these Instructions

1.1 Scope

These instructions are part of the device. These instructions apply to the device in the following versions:

Device	Model
High-capacity precision balance with a rectangular weighing pan	MCA11201S-... MCA20201S-...
	MCA36200S-... MCA36201P-...
	MCA36201S-... MCA50201S-...
	MCA70200S-... MCA70201S-...
High-capacity precision balance with a round weighing pan	MCA32202P-...

1.2 Symbols Used

1.2.1 Warnings in Operating Instructions

WARNING

Denotes a danger with the risk that death or severe injury may result if it is **not** avoided.



CAUTION

Denotes a hazard that may result in moderate or minor injury if it is **not** avoided.

NOTICE

Denotes a danger with the risk that property damage may result if it is **not** avoided.

1.2.2 Other Symbols

-  Required action: Describes actions which must be carried out.
-  Result: Describes the result of the actions carried out.
- [] Text inside brackets refers to control and display items.
- [] Text inside brackets indicates status, warning, and error messages.
-  Indicates information for legal metrology for conformity-assessed (verified) devices. Conformity-assessed devices are also referred to as "verified" in these instructions.

Figures on the Operating Display

The figures on the operating display of the device may deviate from those in these instructions.

1.3 Target Groups

These instructions are addressed to the following target groups. The target groups must possess the specified knowledge.

Target group	Knowledge and responsibilities
User	The user is familiar with the operation of the device and the associated work processes. They understand the hazards which may arise when working with the device and know how to prevent them. They have been trained in the operation of the device. The training is carried out by the operating engineer/laboratory manager or the operator of the device.
Operator	The operator of the device is responsible for compliance with safety requirements and workplace safety regulations. The operator must ensure that all persons who work with the device have access to the relevant information and are trained in working with the device.

2 Safety Instructions

2.1 Intended Use

The device is a high-resolution balance, which can be used in laboratories. The device was developed for the accurate determination of the mass of materials in liquid, paste, powder, or solid form.

Appropriate containers must be used for loading each type of material. The device can be used in stand-alone operation or can be operated on a PC.

The device is intended exclusively for use in accordance with these instructions. Any further use beyond this is considered **improper**.

If the device is **not** used properly: The protective systems of the device may be impaired. This can lead to unforeseeable personal injury or property damage.

Operating Conditions for the Device

Do **not** use the device in potentially explosive environments. The device may only be used indoors.

The device may only be used with the equipment and under the operating conditions described in the Technical Data section of these instructions.

Modifications to the Device

You may **not** modify or repair the device or make any technical changes. Any retrofitting or technical changes to the device are only permitted with prior written permission from Sartorius.

2.2 Personnel Qualification

All persons working on the device must possess the necessary knowledge and responsibilities (see Chapter "1.3 Target Groups", page 6).

If **no** qualifications are indicated for the actions described in these instructions: The actions described are addressed to the "User" target group.

If individual actions must be carried out by other target groups or by Sartorius Service personnel: The qualification required will be indicated in the description of the action.

Significance of these Instructions

Failure to follow the instructions in this manual can have serious consequences, e.g. exposure of individuals to electrical, mechanical, or chemical hazards.

- ▶ Before working with the device, read the instructions carefully and in full.
- ▶ If these instructions are lost, request a replacement or download the latest version from the Sartorius website (www.sartorius.com).
- ▶ Ensure that the information contained in these instructions is available to all individuals working on the device.

2.3 Proper Working Order of the Device

A damaged device or worn parts may lead to malfunctions or cause hazards which are difficult to recognize.

- ▶ Only operate the device when it is safe and in perfect working order.
- ▶ Have any malfunctions or damage repaired immediately by Sartorius Service.

2.4 Symbols on the Device

All symbols appearing on the device, such as warnings and safety labels, must be legible.

- ▶ Do **not** conceal, remove, or modify the symbols.
- ▶ Replace the symbols if they become illegible.

2.5 Electrical Equipment

2.5.1 Damage to the Electrical Equipment of the Device

Damage to the electrical equipment of the device, e.g. damage to the insulation, can be life-threatening. Contact with parts under voltage represents a direct danger to life.

- ▶ If the device's electrical equipment is defective, disconnect the device from the power supply and contact Sartorius Service.
- ▶ Keep live parts away from moisture. Moisture can cause short circuits.

2.5.2 Working on the Electrical Equipment of the Device

Only Sartorius Service personnel may work on or modify the electrical equipment of the device. The device may only be opened by Sartorius Service personnel.

2.5.3 AC Adapter and Power Supply Cable

Serious injury can result, e.g. from electric shocks, if an unsuitable and inadequately dimensioned power supply cable or unsuitable AC adapter is used.

- ▶ Only use the original power supply cable and AC adapter.
- ▶ If the AC adapter or power supply cable must be replaced: Contact Sartorius Service. Do **not** repair or modify the AC adapter or power supply cable.

2.6 Conduct in an Emergency

If there is immediate danger of personal injury or if there is a risk of damage to the device, e.g. due to malfunctions or dangerous situations, the device must be immediately taken out of operation.

- ▶ Disconnect the device from the power supply by disconnecting the power supply cable.
- ▶ Malfunctions should be remedied by Sartorius Service.

2.7 Accessories, Consumables, and Spare Parts

The use of unsuitable accessories, consumables, and spare parts can affect the functionality and safety of the device and have the following consequences:

- Risk of injury to persons
 - Damage to the device
 - Device malfunctions
 - Device failure
-
- ▶ Only use approved accessories, consumables, and spare parts supplied by Sartorius. Information on operational quality is available upon request from Sartorius.
 - ▶ Only use accessories, consumables, and spare parts that are in proper working order.

2.8 Personal Protective Equipment

Personal protective equipment protects against risks arising from the samples used.

- ▶ If the workplace or the measurement process in which the device is being used requires personal protective equipment: Wear personal protective equipment.

2.9 Glass Breakage

Glass components can break if they fall or are handled incorrectly. Glass fragments can cause cuts.

- ▶ Only lift the device by its base.
- ▶ When lifting and transporting, ensure that **no** personnel or objects are in the way.

3 Device Description

3.1 Device Overview



Fig. 1: High-capacity precision balance with a rectangular weighing pan (example)

Pos.	Designation	Description
1	Manufacturer's ID label	Not depicted
2	Leveling foot	Not adjustable, is screwed in for leveling.
3	Weighing module	
4	Leveling foot	Manually adjustable
5	Control unit	
6	Operating display	Touchscreen

3.2 Weighing Pan and Associated Components

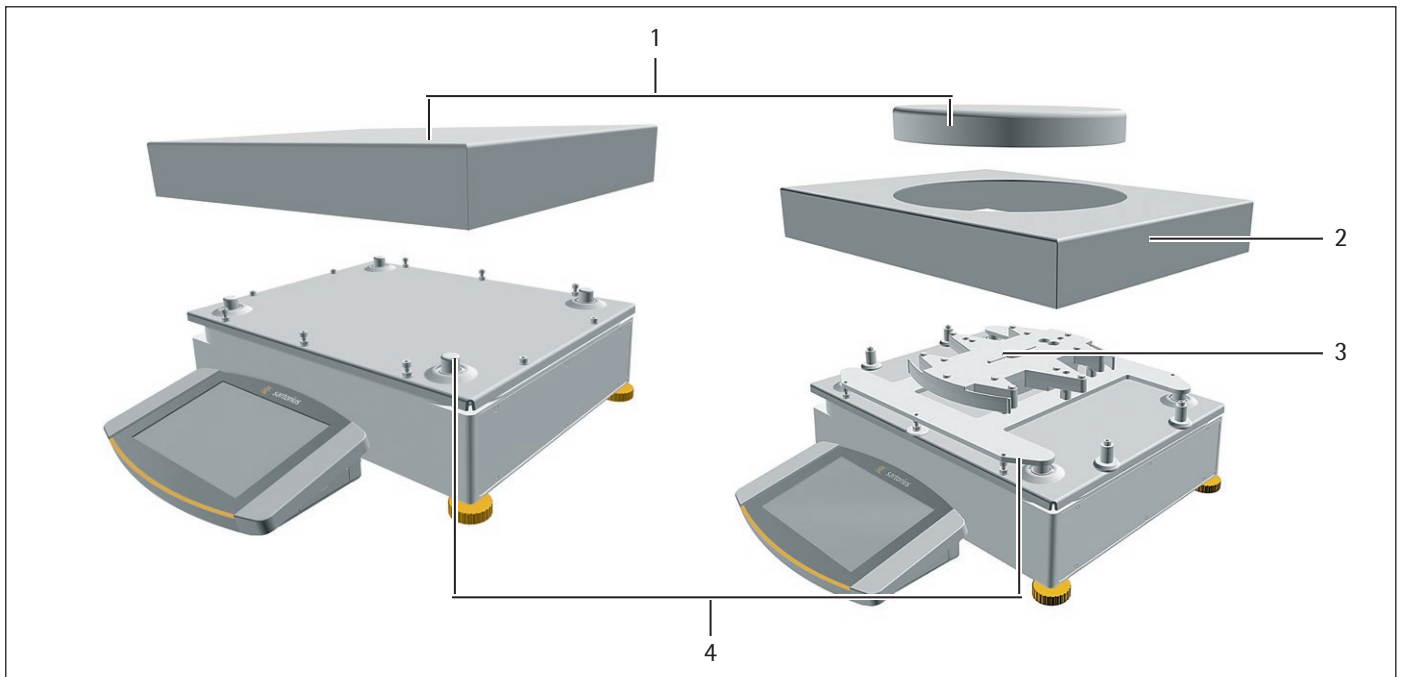

Fig. 2: High-capacity precision balance with a round weighing pan (example)

Pos.	Designation	Description
1	Weighing pan	Rectangular or round
2	Shield frame	
3	Pan support	
4	Pan retainer	

3.3 Connections and Components on the Weighing Module

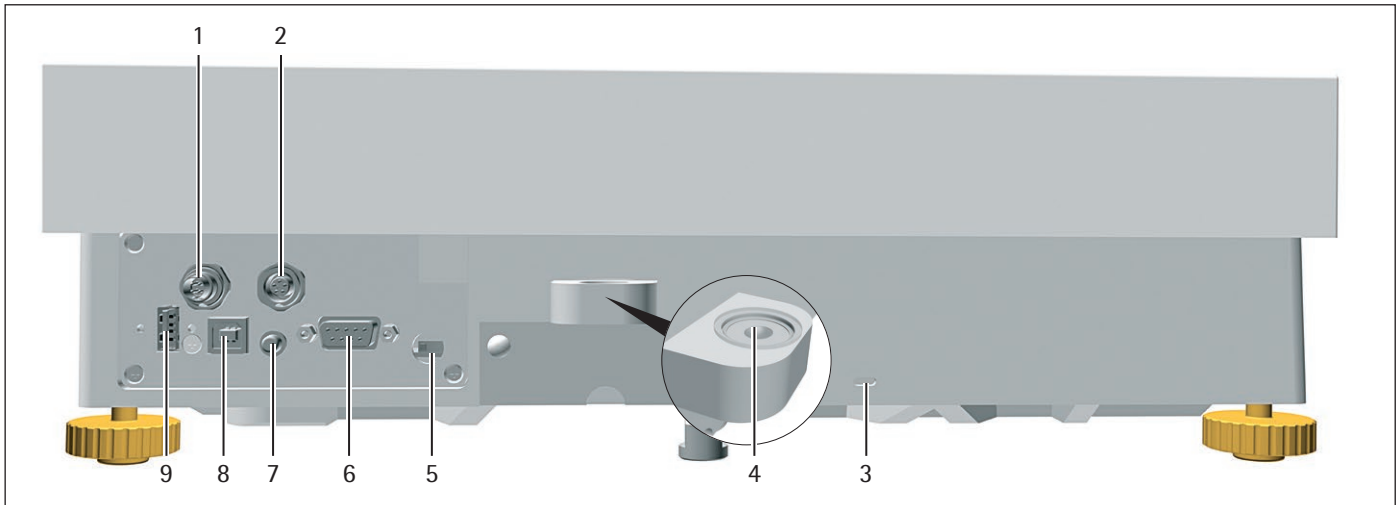

Fig.3: Connections to the weighing module (example)

Pos.	Designation	Description
1	Power supply	For connection to the power supply
2	Peripheral connection	For connecting Sartorius accessories
3	Slot	For attaching a "Kensington" anti-theft device
4	Level	
5	Access switch	Protects the device from changes to the device settings. Is sealed for conformity-assessed devices.
6	COM-RS232 connection	9-pin, for connection to a PC or PLC
7	On key	
8	USB-B connection	For connection to a PC
9	USB-A connection	For USB accessories, e.g. printers, USB mass storage devices, barcode scanners

3.4 Connections on the Control Unit

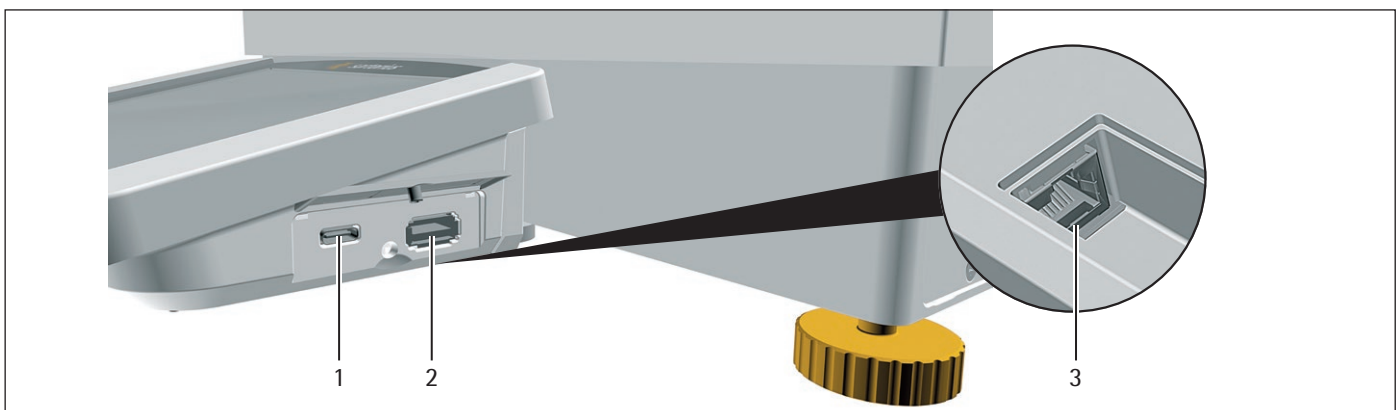

Fig. 4: Connections on the display and control unit (example)

Pos.	Designation	Description
1	USB-C connection	For USB mass storage
2	USB-A connection	For USB accessories, e.g. printers, USB mass storage devices, barcode scanners
3	Ethernet connection	For connecting an Ethernet cable

3.5 Conformity-assessed Devices

Some settings of conformity-assessed models are protected against user changes, e.g. "external calibration" for devices in accuracy class II. This measure is intended to ensure the suitability of the devices for use in legal metrology.

3.6 Symbols on the Device

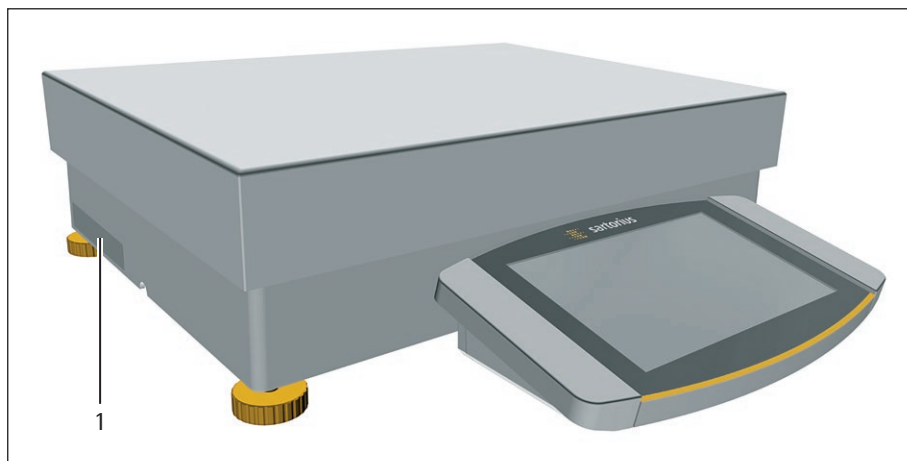



Fig.5: ID label on the device (example)

Pos.	Designation	Description
1	Manufacturer's ID label	Displays the metrological data of the device. Conformity-assessed models only

Symbol	Meaning
	During operation, parts in the device may be live. Only electricians may have access to and work on these parts, such as for maintenance and repairs.

4 Operating Concept

4.1 Operating Elements in the Main Menu

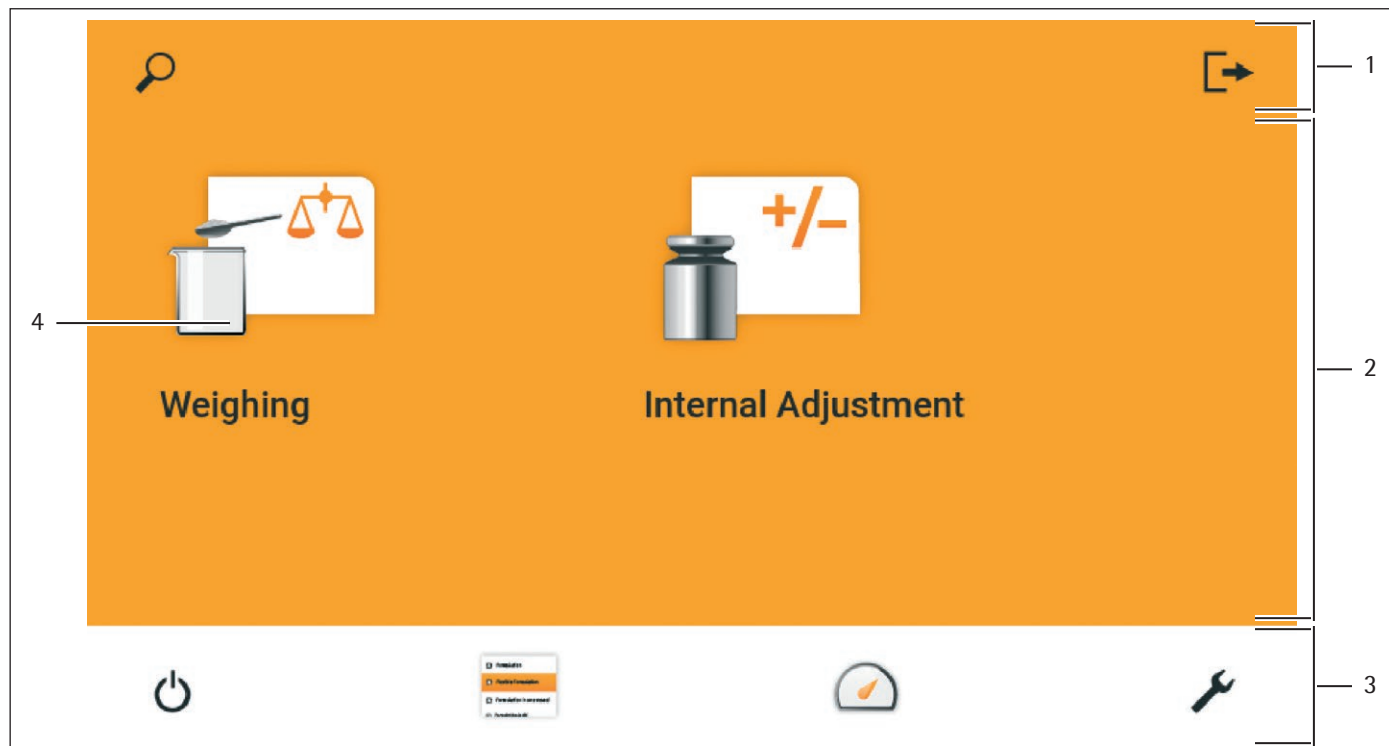

Fig. 1: Operating elements in the main menu (example)

Pos.	Designation	Description
1	Navigation and function bar	<ul style="list-style-type: none"> – Enables navigation, searching, filtering, and sorting in menus and lists. – In the "Settings" Menu: Displays the name of the menu.
2	Available tasks	Displays all tasks available for the active user.
3	Function bar	Displays available submenus and operating functions for the current display and current user.
4	Task	Starts the described task.

4.2 Operating Elements in Task Management

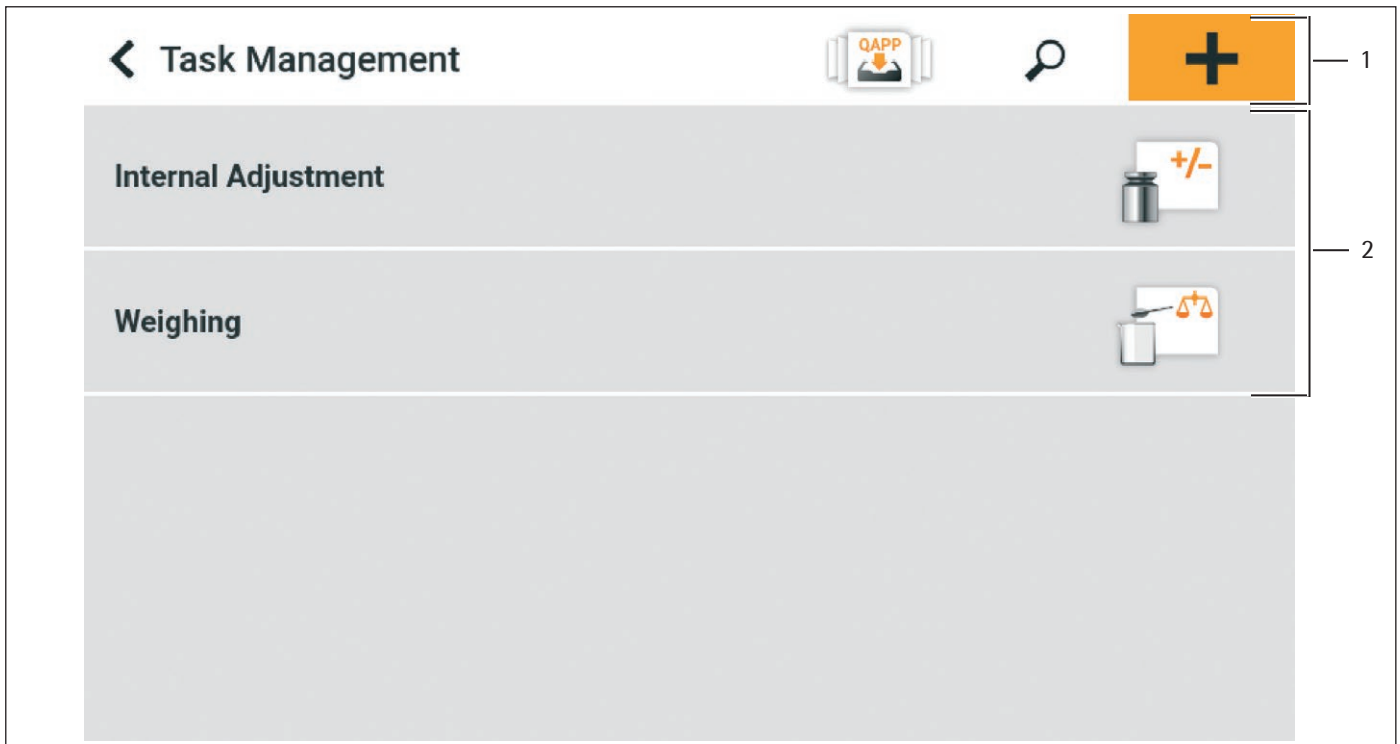

Fig.2: Operating elements in Task Management (example)

Pos.	Designation	Description
1	Navigation and function bar	<ul style="list-style-type: none"> – Enables navigation and searching in menus and lists. – Enables the addition of tasks. – Opens the QAPP center. – Displays the name of the menu.
2	Available tasks	<ul style="list-style-type: none"> – Displays all available tasks. – Opens a summary of the properties for the displayed task.

4.3 Operating Elements in the Weighing Display

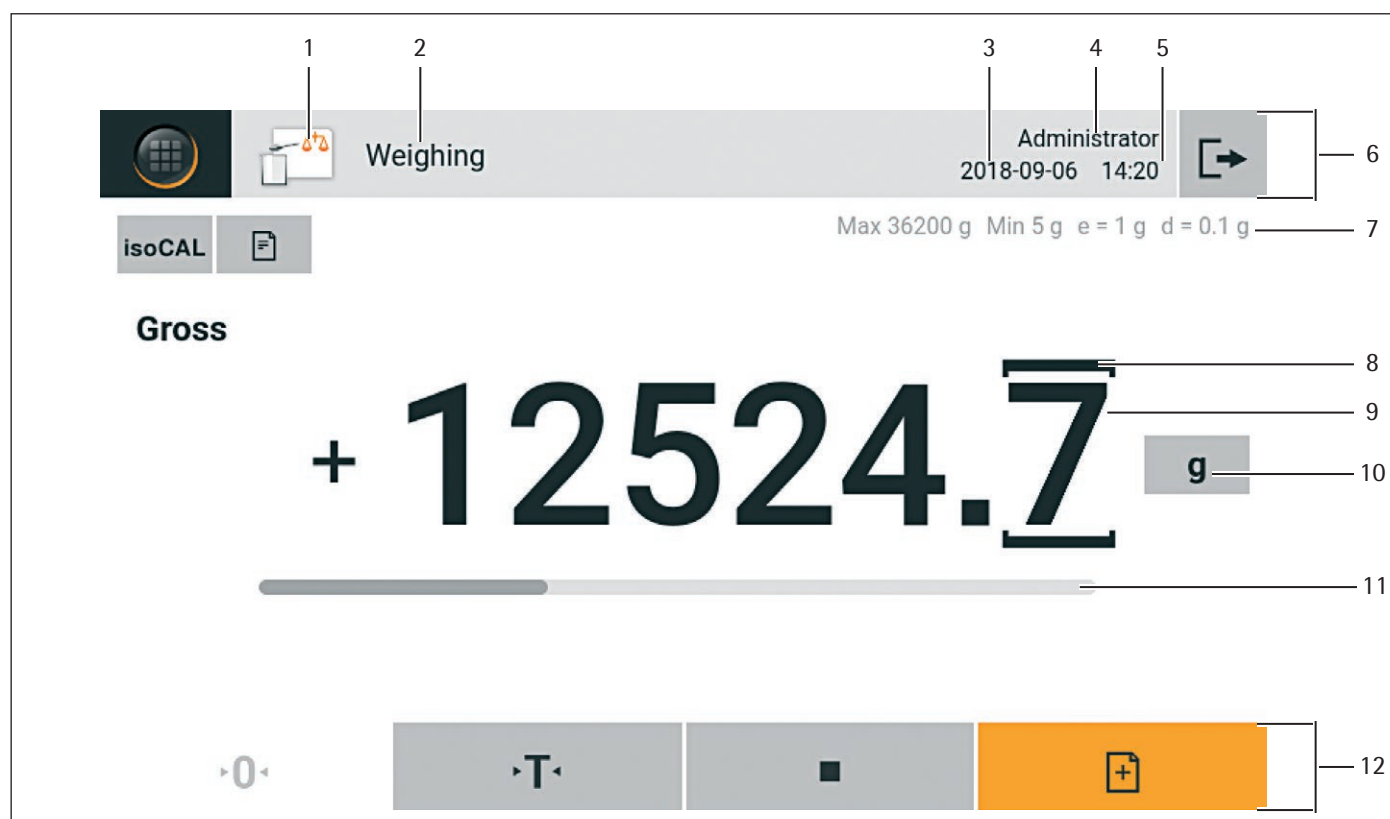

Fig. 3: Weighing display (example)

Pos.	Designation	Description
1	Application symbol	Displays the symbol for the active application.
2	Task name	Displays the name of the active task.
3	Date display	Displays the current date.
4	Username	Displays the name of the active user profile.
5	Time display	Displays the current time.
6	Navigation bar	Enables navigation in menus.
7	Metrological data	
8	Labeled points	Labels the differentiated points.
9	Weight value display	In the selected unit and resolution
10	Weighing unit	Displays the selected unit, e.g. grams, [g]. Enables the unit and resolution to be selected.
11	Bar graph	Displays the measured value as a percentage of weighing capacity utilization.
12	Function bar	Displays available operating functions for the current display.

4.4 Advanced Operator Guidance

Advanced applications have advanced operator guidance.

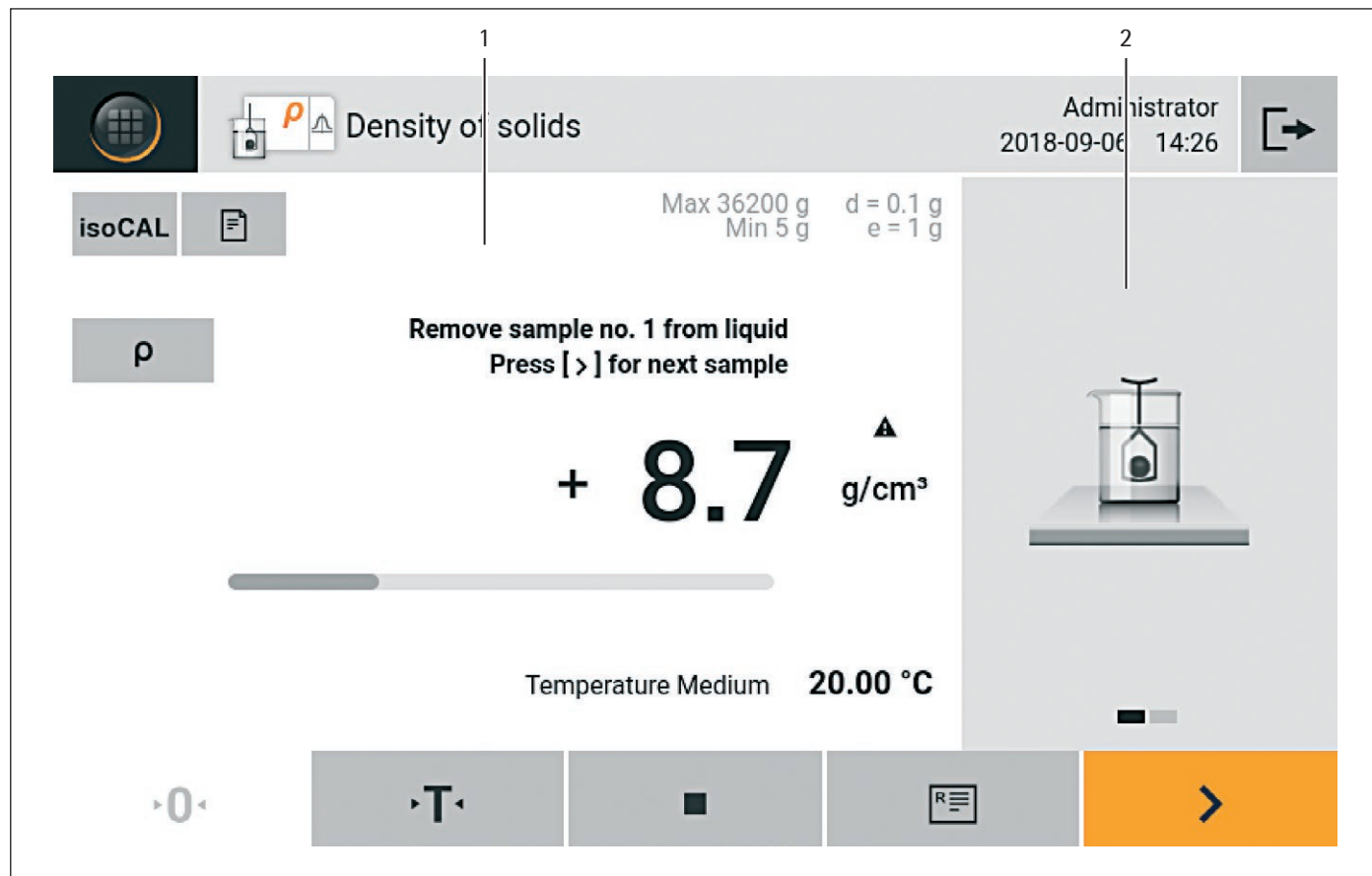

Fig. 4: Advanced operator guidance (example)

Pos.	Designation	Description
1	Weighing display with operator guidance	
2	Advanced operator guidance	<p>Guides the user through the active task. Includes 2 or 3 convertible displays depending on the selected application:</p> <ul style="list-style-type: none"> – First display: Shows the step currently being carried out as a graphic display. – Second display: Shows the current parameters for the task. – Third display, only for applications with statistics function: Represents statistical information as a curve.

4.5 Messages

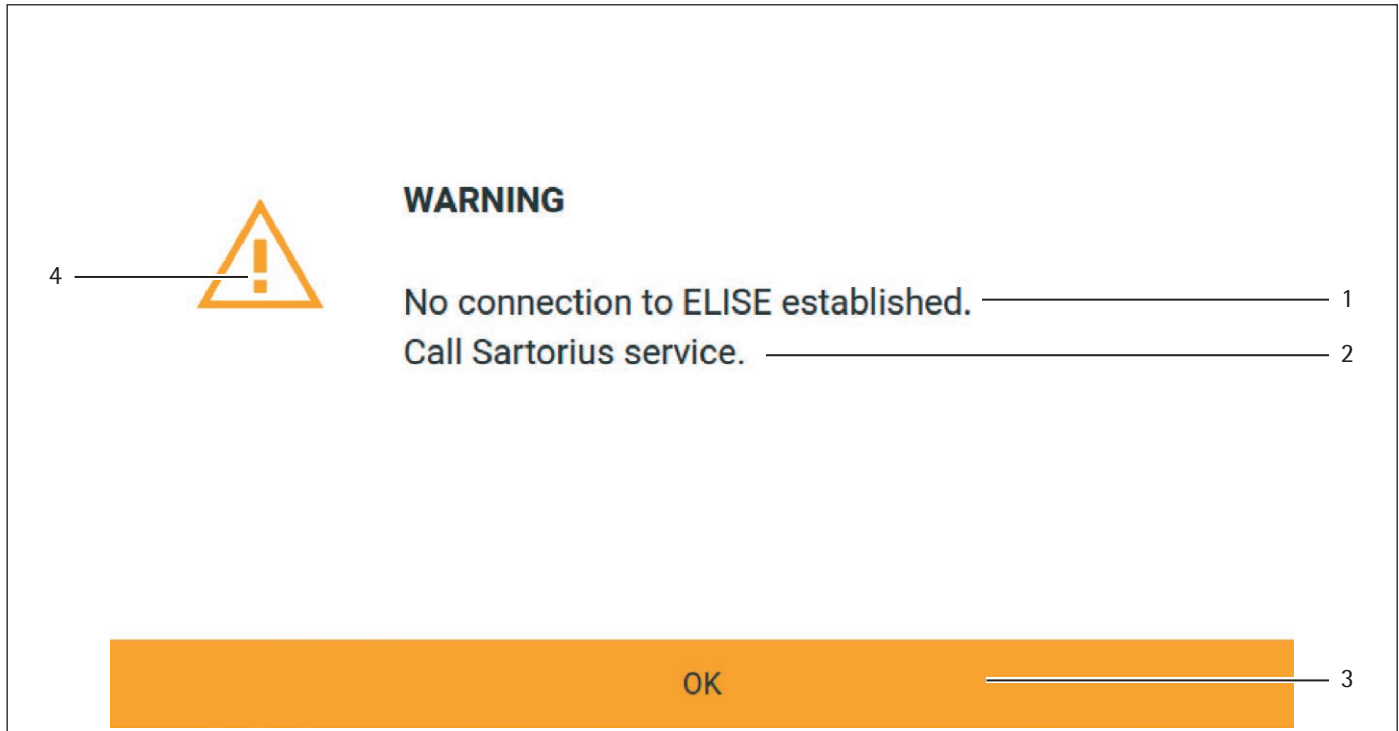

Fig. 5: Error message (example)

Pos.	Designation	Description
1	Description	Specifies the cause.
2	Remedy	Specifies the measures necessary to eliminate the cause of the message.
3	Confirm	Confirms and closes the message.
4	Message type	Indicates that the message is a status message, warning message, or an error message.

4.6 Status Center

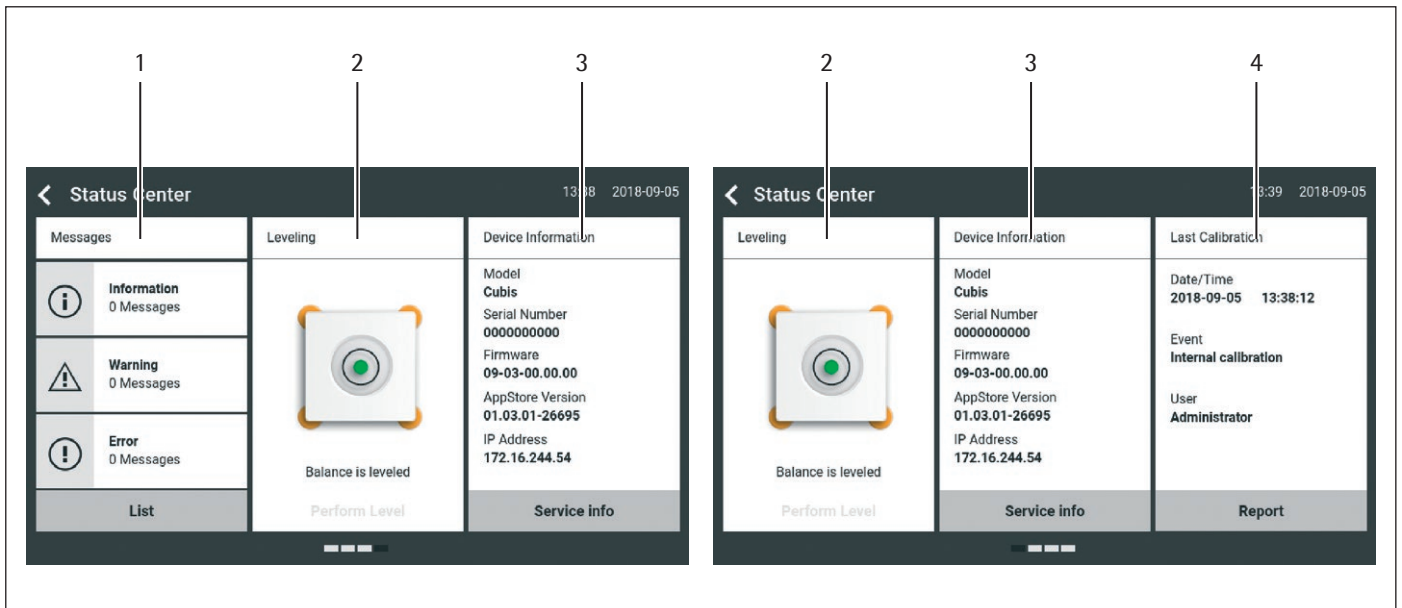

Fig. 6: Status Center (example)

Pos.	Designation	Description
1	Messages	Displays information, warning, and error messages.
2	Leveling status	Displays the status of the level.
3	Status for the device	Displays the general device information.
4	Calibration and adjustment report	Displays the data for the last and next adjustment and calibration.

4.7 Keypad

The keypad is used for entering values in entry fields. If an entry field is activated: The alphanumeric keypad or numerical keypad appears.

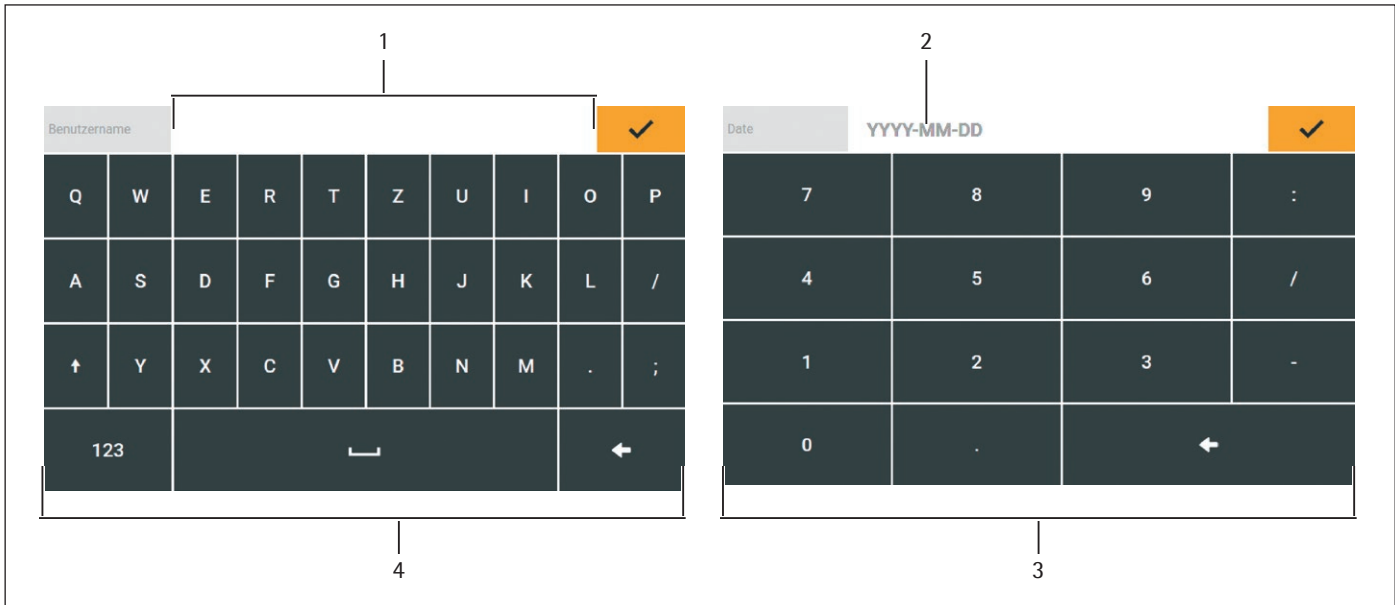

Fig. 7: Alphanumeric keypad and numerical keypad (example)













Pos.	Designation	Description
1	Entry field	
2	Input assistance	Indicates which values can be entered in the entry field, e.g. only numbers.
3	Numeric keypad	
4	Alphanumeric keypad	







4.8 Status Display of the Buttons

Pos.	Symbol	Designation	Description
1		Predominant button	Indicates that the function must be executed. The button is color-highlighted.
2		Secondary button	Indicates that the function can be executed. The button is highlighted gray.
3		Inactive button	Indicates that the function currently cannot be executed. The button is grayed out.









4.9 Buttons in the Operating Display



4.9.1 Buttons for Navigation or Organization in Displays

Pos.	Symbol	Designation	Description
1		[Menu] button	Quits the active task and opens the main menu.
2		[Back] button	<ul style="list-style-type: none"> – Returns to the previous display. – In the main menu: Accesses the last-performed task.
3		[Search] button	Displays options for browsing tasks and list elements.
4		[Filter] button	Displays options for filtering tasks and list elements.
5		[Sort] button	Displays options for sorting tasks and list elements.
6		[Standby] button	Switches the operating display to standby mode.
7		[Task Management] button	Opens Task Management.
8		[Status Center] button	Opens the Status Center.
9		[Setup] button	Opens the "Settings" menu.
10		[User Logout] button	Logs the currently active user out and accesses the login display.
11		[User Login] button	Accesses the login display.
12		[Next] button	Accesses the next display, e.g. the next processing step for a wizard.
13	Service info	[Service Info] button	Opens the "Settings" / "Device Settings" / "Device Information" / "Service" menu.
14	Device info	[Device Info] button	Opens the "Settings" / "Device Settings" / "Device Information" / "General Device Information" menu.
15	List	[Status List] button	Opens an overview of all current status messages, warning messages, and error messages.
16	Leveling	[Leveling] button	Opens the Leveling Wizard.
17		[Warning] button	Opens the list of current warning messages.













Pos.	Symbol	Designation	Description
18		[Error] button	Opens the list of current error messages.
19		[Info] button	<ul style="list-style-type: none"> – Opens a display with additional information using the current menu. – In the Status Center: Opens the list of current status messages.
20		[QAPP Center] button	Opens the QAPP center.
21		[Profile Management] button	Opens Profile Management.
22		[Details] button	Shows additional information about an element.
23		[Display Image] button	Displays available images or videos.
24		[Close Menu] button	Closes the menu.



4.9.2 Buttons for Editing or Managing Entries

Pos.	Symbol	Designation	Description
1		[New] button	<ul style="list-style-type: none"> – In Task Management: Starts the wizard for creating a new task. – In Profile Management: Starts the wizard for creating a new weighing or print profile.
2		[Activate QAPP] button	Opens the display for activating an application.
3		[OK] button	Saves a selection or entry.
4		[More] button	Shows the keypad for entering a user-defined value.
5		[Select All] button	Selects all elements of a list.
6		[Deselect All] button	Deselects the selection for all elements of a list.
7		[Cancel] button	<ul style="list-style-type: none"> – Cancels the current process without saving the changed settings or values. – In the display for editing the print memory: Marks the selected value as invalid.
8		[Edit] button	Accesses the Adjustment Wizard for editing the displayed element, e.g. for setting the parameters for a task.
9		[Delete] button	Deletes the selected element.
10	Licensing	[License] button	Opens the entry field for the license key for activating a QAPP package or application.









Pos.	Symbol	Designation	Description
11		[Keypad] button	Shows the keypad.
12		[Lock] button	Opens the entry field to change the password for the active user.

4.9.3 Weighing and Print Function Buttons

Pos.	Symbol	Designation	Description
1		[Leveling] button	Opens the Leveling Wizard.
2	isoCAL	[isoCAL] button	Starts the isoCAL function.
3	Prc	[Result] button	Toggles between the result and weight value display for the current application, e.g. weighing in percent.
4		[Zero] button	Starts zeroing.
5		[Tare] button	Starts taring.
6		[Tare 1] button	Stores the current weight value in the tare 1 memory.
7	Tare 1 0.00 g	[Tare 1 Entry] button	Opens an entry field for manually entering the tare 1 value.
8	T1 	[Delete Tare 1] button	Deletes the tare 1 memory.
9		[Start] button	Starts the selected application.
10		[Quit] button	Quits the active application and opens the main menu.
11		[Confirm] button	Confirms the current display and initializes the next step.
12		[Save] button	Saves the weight value and sends it to the print memory.
13		[Print memory] button	Opens the Print Memory display.
14		[Print] button	<ul style="list-style-type: none"> – If the Print Memory is displayed: Exports the saved print orders via the integrated data interfaces. – If the weighing display is displayed and the prompt for the sample ID is activated: Opens the entry field for the prompt for the sample ID.
15		[Ionizer] button	Starts an ionization process.
16	g	[Toggle between weight units] button	<ul style="list-style-type: none"> – Toggles between the weight units and the resolution. – Accesses the "Toggle between weight units" function menu.
17		[Restart] button	If an application is active: Deletes the saved values and restarts the application.

Pos.	Symbol	Designation	Description
18		[Report] button	If an application is active, e.g. density determination: Displays a report about the progress of the application.
19		[Result report] button	If an application is active, e.g. density determination: Displays a report about the result of the application.

4.10 Displays in the Operating Display

Pos.	Symbol	Designation	Description
1		[Leveling] display	Indicates that the device is not leveled.
2		[Print memory] display	Indicates that the elements are located in the print memory.
3	g	[Unit symbol] display	Indicates the set weight unit, e.g. [g] for "grams".
4	Gross	[Result] display	Indicates whether the weight value being displayed is a gross value or the result of an application.
5		[Invalid weight value] display	<ul style="list-style-type: none"> – Indicates that the display does not contain a weight value, rather it is the calculated result of an application, e.g. for the "Totalizing" application. – For conformity-assessed devices: Indicates a fault. The cause of this fault is displayed in the Status Center.
6	+ -	[Sign] display	Indicates whether the value being displayed is positive or negative.
7		[Current page] display	<ul style="list-style-type: none"> – Indicates that the current display is a multi-page display. – Indicates which page of a multi-page display is being displayed currently.
8		[Copy] button	Indicates that data are being copied.
9		[Selection] display	Indicates that an entry is selected in a list.
10		[Target value] display	Displays the target value in the bar graph display.
11		[Factory mode] display	Indicates that the device is being operated in the factory default mode.
12		[Service mode] display	Indicates that the device is being operated in the service mode.

4.11 User Management

4.11.1 User Profiles

In the factory, 4 user profiles are created for the device. One role is assigned to each user profile. Each role has rights to operate the device. The rights assigned to each role depend on which device functions the user has to use.

User profiles can be adapted.

4.11.2 User Login

The user must log in to the login display with a user profile. Various setting options and tasks are displayed in the operating display depending on the user profile and role.

4.12 Profile Management

Weighing and print profiles can be created. These profiles can be assigned to a task.

4.13 Applications and Tasks

Device functions such as weighing or calibration and adjustment are carried out using tasks. Applications must be assigned to a task.

A task is visible to all users who are approved for this task.

The device is supplied with some freely accessible applications that can be used to carry out the most important functions.

Additional applications may be activated for a fee.

4.14 Menu Structure

4.14.1 Main Menu

► Navigating in menus (see Chapter 4.15, page 30).

Level 1	Level 2	Level 3	Description
Task management (task menu)			Displays all available tasks. Opens a summary of the properties for the displayed task.
	QAPP center		Display the available QAPP packages.
Status Center			Display information on the device status, e.g. level status.
Settings	General device information		
	User Management		
	Profile Management		
	Device Settings		
	Connections		
	Device Maintenance		

4.14.2 "Settings" Menu

Depending on the approved applications, the device may display additional menus.

► Navigating in menus (see Chapter 4.15, page 30).

Level 1	Level 2	Level 3	Description
Device information	General device information	Manufacturer	Display information about the device's manufacturer.
		Model	Display the device's model ID.
		Serial number	Display the device's serial number.
		Version of device firmware with check number	Display the version of the device firmware with check number.
		QAPP center version	Display the version of the QAPP center.
		IP address	Display the IP address of the device.
		MAC address	Display the MAC address of the device.
	Service	Service contact	Display the responsible contact at Sartorius Service.
		Telephone number	Display the telephone number for Sartorius Service.
		E-mail address	Display the e-mail address for Sartorius Service.
		Technical hotline	Display the technical hotline for Sartorius Service.
		Maintenance contact	Display the responsible contact for maintenance measures.
		Next scheduled maintenance	Display the date for the next scheduled maintenance.
		Maintenance cycle	Display the maintenance cycle.

Level 1	Level 2	Level 3	Description
		Website	Display the website for Sartorius Service.
	Alibi memory		Display, filter, or browse the contents of the Alibi memory.
	Weigh range	Ranges 1–4	Display the values for maximum load, minimum load, scale interval, and calibration step interval for weigh ranges 1–4.
	Diagnostics information	Version of device firmware with check number	Display the version of the device firmware with check number.
		QAPP center version	Display the version of the QAPP center.
		Restore mode version	Display the restore mode version.
		BAC balance processor version	Display the version of the BAC processor.
		APC application processor version	Display the version of the APC processor.
		MCU control processor version	Display the version of the MCU processor.
		WPC draft shield processor version	Display the version of the WPC processor.
	Software licenses		The list of all open source software modules used.
User Management	4 standard user profiles	Summary of the properties of the active user profile	Display or edit the standard user profiles.
Profile Management	Weighing	List of available weighing profiles	Display all available weighing profiles. Edit, create or delete the weighing profiles.
	Report on USB Printer YDP30	List of available print profiles	Display all available print profiles. Edit, create or delete the print profiles.
Device Settings	Date and time	Date format	Define the date display format.
		New date	Enter a date.
		Time format	Define the time display format.
		New time	Enter a new time.
		NTP, Network Time Server	Activate or deactivate time synchronization via NTP.
		IP address of the NTP server	Enter the NTP server IP address.
		Time zone	Determine the time zone.
	Leveling	Automatic leveling (before calibration /adjustment function)	Activate or deactivate automatic leveling before each calibration /adjustment process.
		Leveling alert levels	Set the alert level for the message indicating that the device has not been leveled.
	isoCAL	isoCAL function	Set the isoCAL function.
isoCAL alert levels		Set the alert level for the message indicating that the isoCAL function must be executed.	
Device identifier	ID1 – 2	Determine the device identifier.	

Level 1	Level 2	Level 3	Description
	Self-diagnosis	Software integrity	Display the software status, e.g. the available memory.
		Internal sensors	Settings for monitoring the device components, e.g. the clock module battery.
		Internal actuators	Configure settings for device components, e.g. the motor current for the calibration weight.
		Environment	Configure settings for monitoring the environment, e.g. environmental movements.
	Switch-on behavior	Zero / tare at switch-on	Activate or deactivate automatic zeroing and taring when starting the device.
		Automatic login, last user	Activate or deactivate automatic log-in of the last user when starting the device.
		Automatic start, last task	Activate or deactivate automatic start of the last task when starting the device.
	Properties display	Display brightness	Define the brightness of the operating display.
		Switching the system on/off	Activate or deactivate the "energy saving" function.
		Color scheme	Displays the color scheme of the operating display.
	Sound (loudspeaker)	Sound for touch and keypad operation	Activate or deactivate the acoustic signal when operating a button.
		Sound for the end of execution of an action	Activate or deactivate the acoustic signal for the end of an action.
		Sound for messages	Activate or deactivate the acoustic signal for messages.
Connections	Website for the balance	Website	Determines the settings for the display of the website for the device.
		Remote control display	Define the settings for controlling the device remotely.
	Serial transmission via Ethernet	Protocol	Set the communication protocol for the connected device.
		Port number	Enter the port number for the Ethernet interface.
		Log data	Activate or deactivate the automatic data recording for this interface.
	Interfaces	Serial transmission via Ethernet	Display the profiles for the Ethernet connection. Edit, create or delete the profiles.
		USB-B connection	Display the profiles for the USB-B connection. Edit, create or delete the profiles.
		RS232 connection	Display the profiles for the RS232 connection. Edit, create or delete the profiles.
	SBI protocol	Format	Configure the settings for the data output and data output format.
		Output	Define whether the output takes place with or without stability.
Automatic data output		Activate or deactivate the output rate for automatic data output.	

Level 1	Level 2	Level 3	Description
	PC direct protocol	Output	Define the output format for the data exchange between the balance and the PC.
		Decimal marker of readout	Define the decimal separator character.
	Connected devices	Motion sensor	Define the number and function of the gestures and sensitivity of the motion sensor. Only available if a motion sensor is connected to the device.
		External USB switch	For keys 1–3 on the USB switch, determine which functions are executed when the keys are pressed and released. Only available if an external USB switch is connected to the device.
Device maintenance	Update firmware		Update the firmware. The menu is not available for conformity-assessed devices.
	Update QAPP center		Update the QAPP center.
	Export options		Determine the settings for exporting data from the device.
	Import options		Determine the settings for importing data to the device.
	Restore factory default settings		Reset the device to factory settings.

4.15 Navigating the Menus

Procedure

- ▶ To open a menu from the main menu: Tap on the desired menu button in the function bar.
- ▷ The menu opens and the name of the open menu is displayed in the navigation bar.
- ▶ To return to the main menu from other displays: Press the [Menu] button or press the [Back] button (multiple times) until the main menu is displayed.

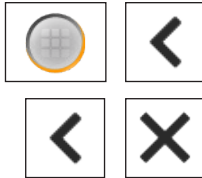

- ▶ To exit a display: Press the [Back] or [Cancel] button.

- ▶ To scroll through the tasks available in the main menu: Swipe the task list to the left or right.

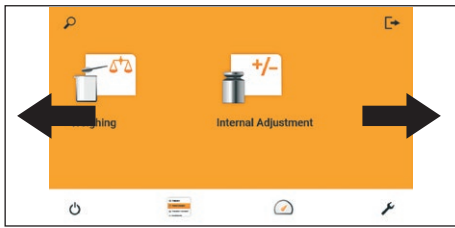

- ▶ To scroll through the list of options in an administration menu (settings, tasks, applications, etc.): Swipe the list downwards or upwards.

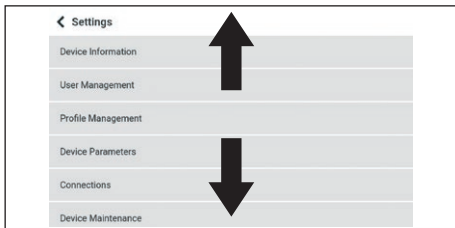

- ▶ To display the next page in a display containing several pages, e.g. in the Status Center: Swipe the display to the left.

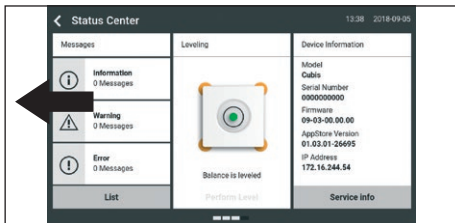

- ▶ To display the previous page in a display with several pages: Swipe the display to the right.

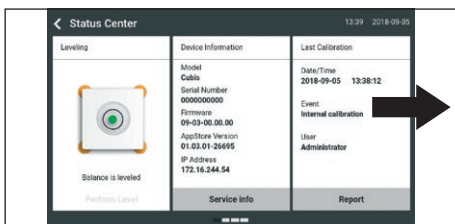

- ▶ If a value needs to be selected from a list:
 - ▶ Scroll to the desired value in the display. In order to do so, swipe the display upwards or downwards.
 - ▶ Press the desired value.
 - ▶ To confirm the selection: Press the [OK] button.
- ▷ The selected value is saved and the list closes.



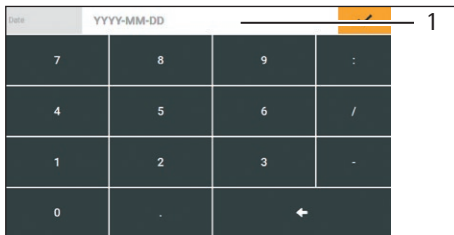

- ▶ If elements from a display need to be filtered or a display needs to be browsed:
 - ▶ Press the [Search] or [Filter] button.
 - ▷ The keypad is displayed.
 - ▶ Type the searched value or value to be filtered into the entry field (1) using the keypad.
 - ▶ Press the [OK] button.
- ▶ To close the entry field for searching and filtering without starting a search or filter operation: Enter **no** value in the entry field or delete the entered value.
 - ▶ Press the [OK] button.

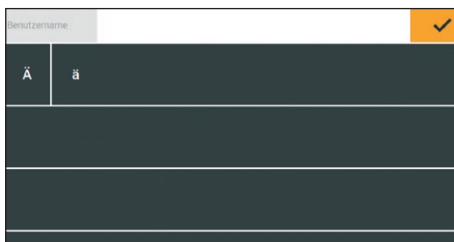

- ▶ If language-specific characters need to be entered using the keypad:
 - ▶ Press and hold a letter on the keypad.
 - ▷ If language-specific characters are available for the letter being pressed: A display opens containing all the language-specific characters available for the letter being pressed.
 - ▶ To select a language-specific character and return to the keypad display: Tap on the desired language-specific character.

5 Installation

5.1 Scope of Delivery

Item	Quantity
Device	1
Weighing pan	1
High-capacity precision balance with a round weighing pan: Shield frame	1
High-capacity precision balance with a round weighing pan: Pan support	1
Power supply unit	1
Country-specific power supply cable with test seal	1
USB connection cable	1
In-use dust cover for control unit	1

5.2 Selecting an Installation Site

Procedure

- Make sure that the following conditions are met at the installation site:

Condition	Features
Ambient conditions	Suitability tested (see Chapter "15.6 Ambient Conditions", page 68)
Setup surface	<p>Stable, even surface that is not exposed to vibrations</p> <p>Not directly against a wall</p> <p>Sufficiently dimensioned for the device and the peripheral devices (device space requirements see Chapter "15.1 Dimensions and Weight", page 66; peripheral device space requirements see instructions for the peripheral devices, e.g. printer)</p> <p>Sufficient load-bearing capacity for the device and the peripheral devices even when full (device weight see Chapter "15.1 Dimensions and Weight", page 66; weight of the peripheral devices see instructions for the peripheral devices, e.g. printer)</p>
Access	Barrier-free

5.3 Unpacking the Device

Procedure

- ▶ Unpack the device at the intended installation location.
- ▶ Lift the device in the Styrofoam padding out of the packaging.
- ▶ Place the device in the Styrofoam padding on its side.
- ▶ Lift the Styrofoam padding off the device.
- ▶ Place the device on its base.
- ▶ Keep all parts of the original packaging, e.g. to return the device.

5.4 Removing the Control Unit

The control unit can be removed. This enables the flexible setup of the control unit at the workplace.

Tool: 1 Torx Allen key, T20

Material: 1 soft support base

Requirements

The weighing pan and all associated components are **not** placed on the device.

Procedure

- ▶ Turn over the device and place on a soft surface.

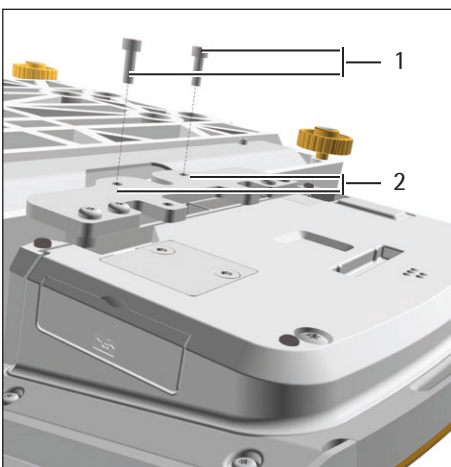

- ▶ To loosen the control unit's retainer: Use the Torx Allen key to remove both screws (1) from the thread (2).
- ▶ Remove the control unit and re-insert both screws into the threaded holes.

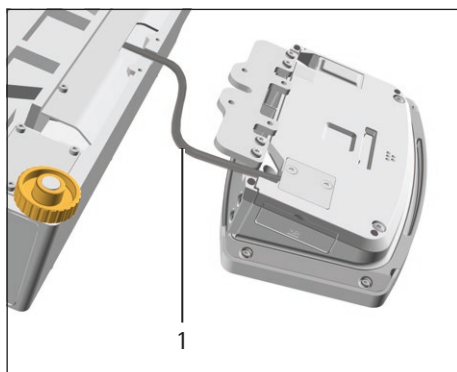

- ▶ Carefully pull the connection cable between the control unit and the weighing module (1) out of the control unit's retainer until it reaches the required length.

- ▶ Turn the device over and place it on an even surface.

5.5 Connecting the Ethernet Cable

Material: 1 Ethernet cable
1 soft support base

Requirements

The weighing pan and all associated components are **not** placed on the device.

Procedure

- ▶ If the control unit is attached to the weighing module: Turn over the device and place on a soft surface.
- ▶ If the control unit is removed from the weighing module: Turn over the control unit and place on a soft surface.
- ▶ Remove the cover (1) of the Ethernet connection socket on the underside of the display and control unit.
- ▶ Plug the Ethernet cable into the Ethernet connection socket.
- ▶ Place the device back on the device base on a level surface.

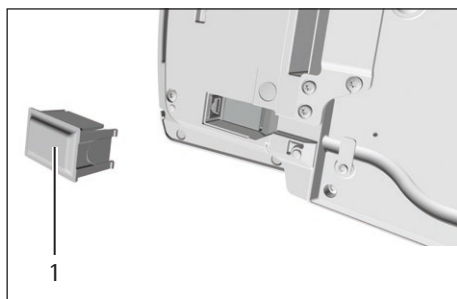

5.6 Preparing Below-balance Weighing

The device can be configured for below-balance weighing. Samples can be suspended for weighing using below-balance weighing, e.g. samples, which do **not** fit on the weighing pan.

For below-balance weighing, the hook must be installed in the device base and the device set up on a weighing table with recess.

M

In legal metrology:

- The below-balance weighing equipment may **not** be used.
- The cover of the below-balance weighing equipment may **not** be opened.

- Tool: 1 suitable screwdriver
- Material: 1 hook for below-balance weighing, available as an accessory from Sartorius
- 1 soft support base
- 1 draft protection shield
- 1 weighing table with recess

Requirements

The weighing pan and all associated components are **not** placed on the device.

Procedure

- ▶ Turn over the device and place on a soft surface.

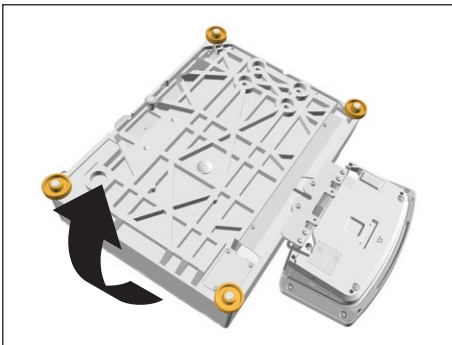

- ▶ Unscrew below-balance cap (1) at the device base with a suitable screwdriver.

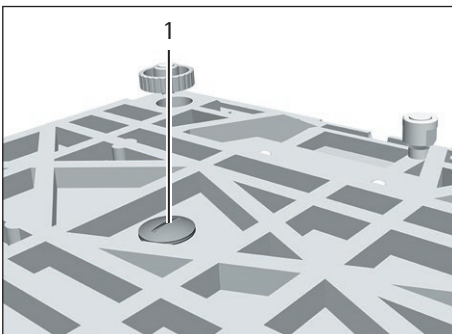

- ▶ **NOTICE** Damage to the device from cross-threading! Ensure that the hook for below-balance weighing (1) is inserted straight into the thread.

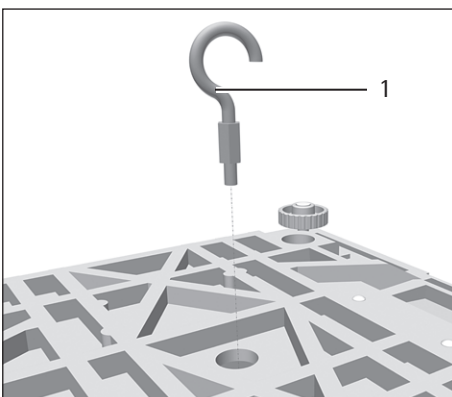

- ▶ Set up the device on the weighing table with recess. The hook for below-balance weighing may **not** touch the floor.
- ▶ Install the draft protection shield.

5.7 Positioning the Weighing Pan and Associated Components

Install Device with a Rectangular Weighing Pan

Procedure

- ▶ Place the weighing pan on the weighing module.

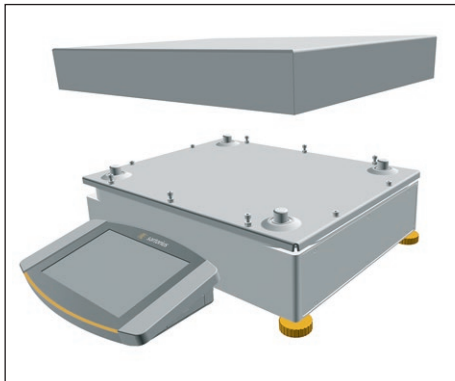

Install Device with a Round Weighing Pan

Procedure

- ▶ Place the shield frame (2) on the weighing module.
- ▶ Place the weighing pan (1) onto the pan support (3).

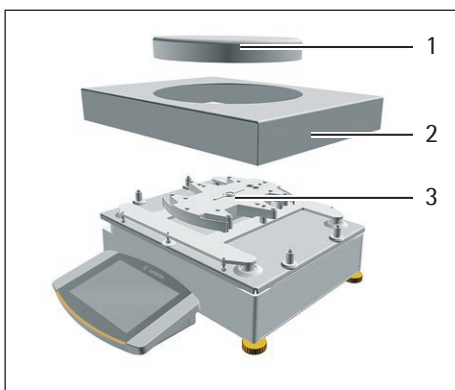

5.8 Acclimatization

When a cold device is brought into a warmer area: The temperature difference can lead to condensation of humidity in the device (moisture formation). Moisture in the device can lead to malfunctions.

- ▶ Allow the device to acclimatize for approx. 2 hours at the installation site. The device must be disconnected from the power supply beforehand.

6 Getting Started

Procedure

- ▶ **NOTICE** Improper connection may damage the device! If the device is connected using electronic components, e.g. printer, PC: The device must be disconnected from the power supply. Ensure that the device is disconnected from the power supply.
- ▶ Connect the device using electronic components (see electronic components instructions).

6.1 Installing the AC Adapter

Procedure

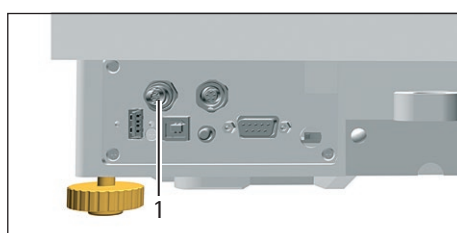

- ▶ Plug the DC supply cable of the AC adapter into the device's "power supply" (1) connection socket and tighten the threaded fitting.

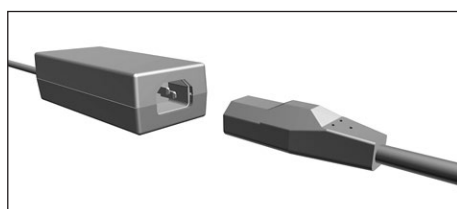

- ▶ Connect the power supply cable to the AC adapter connection.

6.2 Connecting the Power Supply

Procedure

- ▶ **⚠ WARNING** Severe injuries caused by using a defective power supply cable! Check the power supply cable for damage, e.g., cracks in the insulation.
 - ▶ If required: Contact Sartorius Service.
- ▶ Check whether the country-specific power plug matches the power connections at the installation site.
 - ▶ If required: Contact Sartorius Service.
- ▶ **NOTICE** Damage to the device due to excessive input voltage! Check whether the voltage specifications on the AC adapter match those of the power supply at the installation site.
 - ▶ If the input voltage is too high: Do **not** connect the device to the power supply.
 - ▶ Contact Sartorius Service.
- ▶ Connect the mains plug of the power supply cable to the wall outlet at the installation site.
 - ▷ The [Booting device...] display appears in the operating display.
 - ▷ The [Starting system...] display appears in the operating display.
 - ▷ The [Starting application...] display appears in the operating display.
 - ▷ The [Loading] display appears in the operating display.
 - ▷ The device performs an initial tare function.

7 System Settings

7.1 Performing System Settings

Default settings can be adjusted for the device and the applications in order to align with the ambient conditions and individual operating requirements.

The following settings are necessary to operate the device together with connected components:

- Set up the communication of the connected devices
- Set up additional components

The following settings are recommended to set up the device:

- Set the menu language
- Select date/time format
- Set date/time
- Assign a Password

Procedure

- ▶ Open the main menu.
- ▶ Press the [Setup] button.
- ▶ To adjust settings: Open the desired submenu.
- ▶ Select the desired configuration value (configuration values, see Chapter "7.4 Parameter List", page 39).
- ▶ Exit the menu.

7.2 Switching Off the isoCAL Function

M

If the isoCAL function is switched off for a conformity-assessed device: The device can only be used for legal-for-trade applications in restricted temperature ranges (see Chapter "15.6.2 Ambient temperature for the isoCAL function", page 68). The isoCAL function **cannot** be switched off for all model versions.

Procedure

- ▶ In the "Settings/Device Settings/isoCAL" menu, for the "isoCAL function" parameter, select the "Off" configuration value.

7.3 Assigning a Password

Procedure

- ▶ Log into the device using the user profile; a password should be assigned.
- ▶ Open the "Settings/User Configuration" Menu.
- ▶ Press the [Lock] button.
- ▷ The user password input field is displayed.
- ▶ Enter the desired password in the entry field and confirm with the [OK] button.

7.4 Parameter List

7.4.1 Parameters in the "User Configuration" Menu

Parameters	Setting values	Explanation
Name	User input	Assign a name for the user profile.
Description	User input	Enter a description for the user profile.
User color		Define a user color for the user profile.
Language		Set the menu language for the user profile.
Log-on method		Determine whether the user password is saved locally on the device or provided by an IDAP network server.

* Factory setting

7.4.2 Parameters in the "Profile Management" Menu

Parameters in the "Weighing" Submenu

Parameters	Setting values	Explanation
Ambient conditions	Very stable	Sets the ambient conditions to "very stable": Activates a fast change in the weight values in the event of a load change with a high output rate. Recommended for the following work environment: <ul style="list-style-type: none"> – Very stable table near the wall – Closed and calm room
	Stable	Sets the ambient conditions to "stable". Recommended for the following work environment: <ul style="list-style-type: none"> – Stable table – Slight movement in the room – Slight draft
	Unstable*	Sets the ambient conditions to "unstable": Activates the delayed change in weight values with a reduced output rate. Recommended for the following work environment: <ul style="list-style-type: none"> – Simple office desk – Room with moving machinery or personnel – Slight air movement
	Very unstable	Sets the ambient conditions to "very unstable": Activates a significantly delayed change in the weight values and long wait for stability with a further reduction in the output rate. Recommended for the following work environment: <ul style="list-style-type: none"> – Noticeable and slow floor vibrations – Noticeable building vibrations – Weighed goods moved – Very strong air movements

* Factory setting

Parameters	Setting values	Explanation
Application filter	Weighing (final readout)*	Activates a filter that enables a fast change in the display for very fast load changes. Display changes with minimal load changes (in the digit range) occur more slowly.
	Dosing (initial weighing)	Activates a filter that enables a very fast change in the display with minimal load changes (e.g. when filling containers).
	Sensor mode (low filtering)	Activates a weak but fast filter that always behaves in the same way for load changes (e.g. when filling automated systems).
	Dynamic mode (without filtering)	Deactivates the active application filter.
Stability	Very high degree of accuracy	Sets the stability to "very high degree of accuracy".
	High degree of accuracy	Sets the stability to "high degree of accuracy".
	Average degree of accuracy*	Sets the stability to "average degree of accuracy".
	Fast	Sets the stability to "fast".
	Very fast	Sets the stability to "very fast".
	Very slow	Sets the stability to "very slow".
Stability delay	Very short	Sets the stability delay to "very short": The stability symbol is displayed after the stability criterion is reached.
	Short*	Sets the stability delay to "short": The stability symbol only appears after a short delay in order to provide a reliable result despite fluctuations.
	Medium	Sets the stability delay to "medium": The stability symbol only appears after a longer delay in order to provide a reliable result in case of higher fluctuations.
	Long	Sets the stability delay to "long": The stability symbol only appears after a long delay in order to balance out major instability.
Zeroing/Taring	Without stability	Without stability: The function of the [Zero] or [Tare] key is executed immediately once the key is pressed.
	With stability*	With stability: The function of the [Zero] or [Tare] key is only executed after stability is achieved.
	At stability	At stability: The function of the [Zero] or [Tare] key is executed if stability exists when the key is pressed.
Automatic zeroing	On*	Activates automatic zeroing. The display is automatically set to zero in case of a deviation of 0 less than (X).
	Off	Deactivates automatic zeroing. Zeroing must be triggered with the [Zero] key.
Tare preset 1	On*	Activates the initial taring/zeroing. The device is tared or zeroed after it is switched on.
	Off	Deactivates the initial taring/zeroing. After it is switched on, the device shows the value before it was last switched off.
* Factory setting		

Parameters	Setting values	Explanation
Available units		The availability of units may depend on national legislation and is therefore country-specific. Multiple selection is possible.
	mg – milligrams*	The device displays the weight in milligrams.
	g – grams*	The device displays the weight in grams.
	kg – kilograms*	The device displays the weight in kilograms.
	ct – carats*	The device displays the weight in carats.
	lb – pounds	The device displays the weight in pounds.
	oz – ounces	The device displays the weight in ounces.
	ozt – troy ounces	The device displays the weight in troy ounces.
	tlh – Hong Kong taels	The device displays the weight in taels (Hong Kong).
	tls = Singapore taels	The device displays the weight in taels (Singapore).
	tlt – Taiwanese taels	The device displays the weight in taels (Taiwan).
	tlc = Chinese taels	The device displays the weight in taels (China).
	GN – grain	The device displays the weight in grains.
	dwt = pennyweight	The device displays the weight in pennyweights.
	mom – mommes	The device displays the weight in mommes.
	tol – tolas	The device displays the weight in tolas.
	bat – baht	The device displays the weight in baht.
MS – mesghals	The device displays the weight in mesghals.	
N – newtons	The device displays the weight in newtons.	
Available resolutions	Show all decimal places*	"Show all decimal places": All decimal places are shown in the display. Not available on conformity-assessed devices.
	Last decimal place after load change	"Reduced by 1 decimal place for load change": The last decimal place on the display is switched off until stability is achieved.
	Last decimal place of the 1st division	"Last decimal place of the 1st division": The last decimal place always shows the 1st division.
	Last decimal place off	"Last decimal place off": The last decimal place is switched off.
Name	User input	Assign a name for the weighing profile, e.g. "weighing".
Description	User input	Enter a description for the weighing profile (optional).
* Factory setting		

Parameters in the "Report on USB Printer YDP30" Submenu

Parameters	Setting values	Explanation
GLP printing	Off*	Deactivates the GLP printout.
	On	The GLP printout is always switched on. All printouts contain a GLP header and a GLP footer.
Date/Time	Off*	Exports the measured value without the date and time.
	On	Exports the measured value with the date and time.
Block pressure (N,T,GC)	Off*	Exports the measured value without the gross, net, and tare value.
	On	Exports the measured value with the gross, net, and tare value.
* Factory setting		

Parameters	Setting values	Explanation
Character memory	Off*	Deactivates the ID marking for the Alibi memory.
	On	Activates the ID marking for the Alibi memory.
Name	User input	Assign a name for the print profile, e.g. "YDP30".
Description	User input	Enter a description for the print profile (optional).
* Factory setting		

7.4.3 Parameters in the "Device Settings" Menu

Parameters in the "Date and Time" Submenu

Parameters	Setting values	Explanation
Date format	DD/MM/YYYY	Sets the date display format to DD/MM/YYYY
	MM/DD/YYYY	Sets the date display format to MM/DD/YYYY
	DD.MM.YYYY	Sets the date display format to DD.MM.YYYY
	YYYY-MM-DD (ISO)*	Sets the date display format to YYYY-MM-DD (ISO)
New date	User input	Saves the entered date.
Time format	HH.MM.SS	Sets the time display format to HH.MM.SS
	HH:MM:SS (ISO)*	Sets the time display format to HH:MM:SS (ISO)
	HH:MM:SS am/pm	Sets the time display format to HH:MM:SS am/pm
New time	User input	Saves the entered time.
NTP	NTP active	Activates the time synchronization with the NTP server.
	NTP not active*	Deactivates the time synchronization with the NTP server.
IP address of the NTP server	User input	Saves the entered server ID for the NTP server.
Time zone	List of available time zones	Saves the selected time zone.
* Factory setting		

Parameters in the "Leveling" Submenu

Parameters	Setting values	Explanation
Automatic leveling	Off	Deactivates the trigger for automatic leveling: The leveling process must be started manually.
	On*	Activates the trigger for automatic leveling: The Leveling Wizard is opened before every internal adjustment/calibration.
Leveling alert levels	Low: For information only	If the device must be leveled: The device displays a status message.
	Medium: Warning message*	If the device must be leveled: The device displays a warning message. Some device functions are limited until the device is leveled: The displayed weight value is marked as invalid; printed data are marked with [!].
	High: Error message, leveling mandatory	If the device must be leveled: The device displays an error message. Some device functions are limited until the device is leveled: The displayed weight value is marked as invalid; the starting of applications and saving of values is disabled; data output is deactivated.
* Factory setting		

Parameters in the "isoCAL" Submenu

Parameters	Setting values	Explanation
isoCAL function	Off	Deactivates the isoCAL function. This setting change is not available for all models.
	Info, manual execution	If the device must be calibrated: The [isoCAL] button is displayed as the predominant button in the operating display. The isoCAL function must be manually triggered using the [isoCAL] button.
	On, automatic execution*	Activates the isoCAL function. The device is automatically adjusted as soon as a trigger starts the isoCAL function.
	On, automatic execution with linearization (only if possible)	Activates the isoCAL and linearization function. The device is automatically adjusted and then linearized as soon as a trigger starts the isoCAL function.
isoCAL alert levels	Low: For information only	If the isoCAL function must be carried out: The device displays a status message.
	Medium: Warning message*	If the isoCAL function must be carried out: The device displays a warning message. Some device functions are limited until the device is leveled: The displayed weight value is marked as invalid; printed data are marked with [!].
	High: Error message, adjustment mandatory	If the isoCAL function must be carried out: The device displays an error message. Some device functions are limited until the device is leveled: The displayed weight value is marked as invalid; the starting of functions and saving of data in tasks is disabled; data output is deactivated.

* Factory setting

Parameters in the "Device ID" Submenu

Parameters	Setting values	Explanation
ID 1	User input	Saves the entered device ID.
ID 2	User input	Saves the entered device ID.

* Factory setting

Parameters in the "Device Monitoring" Submenu

Parameters	Setting values	Explanation
Clock module battery	Off	Deactivates the monitoring for the clock module battery.
	On	Activates the monitoring for the clock module battery.
Temperature compensation status	Off	Deactivates the monitoring for the temperature compensation status.
	On	Activates the monitoring for the temperature compensation status.
Calibration weight motor current	Off	Deactivates the monitoring of the motor current for positioning the internal calibration weight.
	On	Activates the monitoring of the motor current for positioning the internal calibration weight.
Available memory, warning limit	User input	Saves the entered value. If the available storage space is less than the entered value: The device displays a warning message.
Available memory, critical limit	User input	Saves the entered value. If the available storage space is less than the entered value: The device displays an error message.

* Factory setting

Parameters in the "Startup Behavior" Submenu

Parameters	Setting values	Explanation
Zero/tare at switch-on	Off	Deactivates automatic zeroing and taring when starting the device.
	On*	Activates automatic zeroing and taring when starting the device.
Automatic login, last user	Off*	Deactivates "Automatic login, last user". No user is logged in automatically when starting the device.
	On	Activates "Automatic login, last user". The last user is logged in automatically when starting the device.
Automatic start, last task	Off*	No task is started automatically after device login.
	On	After logging-in on the device, the task being performed by the last user to be logged in starts automatically.

* Factory setting

Parameters in the "Display Settings" Submenu

Parameters	Setting values	Explanation
Display brightness	Bright	Sets the lighting intensity on the operating display to "bright".
	Medium*	Sets the lighting intensity on the operating display to "medium".
	Eco mode	Activates eco mode. For longer periods of downtime, the operating display darkens automatically.
Switching the system on/off	Energy saving, short switch-on time*	Sets idle mode: The [Standby] button switches the device into idle mode. The device can be reactivated by pressing the [Standby] button.
	Maximum energy saving, long switch-on time	Sets standby mode: The [Standby] button switches the device into standby mode. The device must be reactivated by pressing the ON key.
Color Scheme	Sartorius Standard*	Selects the color scheme for the "Sartorius Standard" operating display. Additional color schemes can be unlocked via the QAPP center.

* Factory setting

Parameters in the "Sound (Loudspeaker)" Submenu

Parameters	Setting values	Explanation
Sound for touch and keypad operation	Off*	Deactivates the acoustic signal for touch and keypad operation.
	On	Activates the acoustic signal for touch and keypad operation.
Sound for the end of execution of an action	Off*	Deactivates the acoustic signal for the completion of an action.
	On	Activates the acoustic signal for the completion of an action.
Sound for messages	Off	Deactivates the acoustic signal for messages.
	On*	Activates the acoustic signal for messages.

* Factory setting

7.4.4 Parameters in the "Connections" Menu

Parameters in the "Website for the Balance" Submenu

Parameters	Setting values	Explanation
Website	Off	Deactivates the display of the website for the device.
	On, without authentication*	Sets the display options of the website for the device to "without authentication".
	On, with authentication	Sets the display options of the website for the device to "with authentication".
Remote control and display	Display only*	Permits remote access in view mode via a browser.
	Display and remote operation	Permits remote access via a browser.

* Factory setting

Parameters in the "Serial Transmission via Ethernet" Submenu

Parameters	Setting values	Explanation
Protocol	Off*	Deactivates the serial transmission via Ethernet.
	SBI	Enables SBI communication. The data is output to a PC or control unit. Enables the use of ESC commands from a PC to control the basic balance functions with ASCII protocol.
	xBPI	Extended range of commands to control numerous balance functions with binary protocol for direct communication with the weighing module.
Port number	User input	Saves the entered port number for the Ethernet interface.
Log data	Off*	Deactivates the automatic data recording for this interface.
	On	Activates the automatic data recording for this interface.

* Factory setting

Parameters in the "USB-B connection" Submenu

Parameters	Setting values	Explanation
Protocol	Off*	Deactivates the USB-B connection.
	SBI	Enables SBI communication. The data is output to a PC or control unit. Enables the use of ESC commands from a PC to control the basic balance functions with ASCII protocol.
	PC direct	Enables data output to a spreadsheet program via a direct PC connection.
	xBPI	Extended range of commands to control numerous balance functions with binary protocol for direct communication with the weighing module.
Log data	Off*	Deactivates the automatic data recording for this interface.
	On	Activates the automatic data recording for this interface.

* Factory setting

Parameters in the "RS232 Connection" Submenu

Parameters	Setting values	Explanation
Protocol	Off*	Deactivates the RS232 connection.
	SBI	Enables SBI communication. The data is output to a PC or control unit. Enables the use of ESC commands from a PC to control the basic balance functions with ASCII protocol.
	xBPI	Extended range of commands to control numerous balance functions with binary protocol for direct communication with the weighing module.
Log data	Off*	Deactivates the automatic data recording for this interface.
	On	Activates the automatic data recording for this interface.
Baud rate	600 baud	Sets the baud rate to 600 baud.
	1200 baud	Sets the baud rate to 1200 baud.
	2400 baud	Sets the baud rate to 2400 baud.
	4800 baud	Sets the baud rate to 4800 baud.
	9600 baud*	Sets the baud rate to 9600 baud.
	19200 baud	Sets the baud rate to 19200 baud.
	38400 baud	Sets the baud rate to 38400 baud.
	57600 baud	Sets the baud rate to 57600 baud.
Data bits	115200 baud	Sets the baud rate to 115200 baud.
	7 data bits	Sets the number of data bits to 7.
Parity	8 data bits*	Sets the number of data bits to 8.
	Odd*	Applies an odd parity.
	Even	Applies an even parity.
Stop bits	None	Does not apply a parity.
	1 stop bit*	Sets the number of stop bits to 1.
Handshake	2 stop bit	Sets the number of stop bits to 2.
	Software	Sets the handshake protocol to software handshake.
	Hardware*	Sets the handshake protocol to hardware handshake.
Log data	None	Does not set a handshake protocol.
	Off*	Deactivates the automatic data recording for this interface.
	On	Activates the automatic data recording for this interface.

* Factory setting

Parameters in the "SBI Protocol" Submenu

Parameters	Setting values	Explanation
Format	Readout without identifier	The data output only exports the measured value without ID code.
	Readout with identifier*	The data output exports the measured value with ID codes.
	Date/time and readout	The data output exports the measured value, date, and time.
	Readout with weighing block (N, T, GC)	The data output exports the measured value with the net, tare, and calculated gross value.
Output	without stability*	The data is output without the weight value being stable.
	with stability	The data is output only when the weight value is stable.
Automatic data output	Off, triggered by means of SBI commands (ESC P)*	Deactivates the automatic data output. The data output must be triggered by means of an SBI command.
	Each weight value (according to display result)	Starts the automatic data output with each value.
	1 second	Starts the automatic data output after every second.
	2 seconds	Starts the automatic data output every 2 seconds.
	5 seconds	Starts the automatic data output every 5 seconds.
	10 seconds	Starts the automatic data output every 10 seconds.
	30 seconds	Starts the automatic data output every 30 seconds.
	60 seconds	Starts the automatic data output every 60 seconds.

* Factory setting

Parameters in the "PC Direct Protocol" Submenu

Parameters	Setting values	Explanation
Output (TAB-separated), multiple selection	Text (identifier, value, and unit)	The data output exports the measured value with identifier and unit directly into a spreadsheet program.
	Title (in regional language)	The data output exports the title in the regional language directly into a spreadsheet program.
	Identifier*	The data output exports the identification codes (IDs) directly into a spreadsheet program.
	Readout*	The data output exports the readout directly into a spreadsheet program.
	Unit*	The data output exports the displayed unit directly into a spreadsheet program.
Decimal marker of readout	Decimal point*	Sets a point as a decimal separator for the data output.
	Decimal comma	Sets a comma as a decimal separator for the data output.

* Factory setting

Parameters in the "Motion Sensor" Submenu (Only Where a Motion Sensor is Connected)

Parameters	Setting values	Explanation
Number of gestures	2 gestures (left, right)*	Activates the control of functions with 2 gestures. Gestures: Left, right
	4 gestures (left, right, up, down)	Activates the control of functions with 4 gestures. Gestures: Left, right, top, bottom
Sensor sensitivity	Weak	Sets the gesture control response threshold to a low value: Gestures are recognized at a close distance.
	Normal*	Sets the gesture control response threshold to a medium value: Gestures are recognized at a medium distance.
	High	Sets the gesture control response threshold to a high value: Gestures are recognized at a great distance.
Gesture to the left Gesture to the right	Execute/cancel taring	The gesture starts a taring process or cancels a taring process.
	Execute/cancel zeroing	The gesture starts the zeroing process or cancels the zeroing process.
	Execute/cancel printing	The gesture starts a printing process or cancels a printing process.
Gesture upwards Gesture downwards	Execute/cancel taring	The gesture starts a taring process or cancels a taring process. Only available if the number of gestures is set to 4 gestures.
	Execute/cancel zeroing	The gesture sets the device to zero or cancels the zeroing process. Only available if the number of gestures is set to 4 gestures.
	Execute/cancel printing	The gesture starts a printing process or cancels a printing process. Only available if the number of gestures is set to 4 gestures.

* Factory setting

Parameters in the "External USB Switch" Submenu (Only Where an External USB Switch is Connected)

Parameters	Setting values	Explanation
Key 1 pressed Key 1 released Key 2 pressed Key 2 released Key 3 pressed Key 3 released	Execute/cancel taring	The key starts a taring process or cancels a taring process.
	Execute/cancel zeroing	The key sets the device to zero or cancels the zeroing process.
	Execute/cancel printing	The key starts a printing process or cancels a printing process.

* Factory setting

Parameters in the "Device Maintenance" Submenu

Parameters	Setting values	Explanation
Update firmware		Starts a firmware update. Not for conformity-assessed devices.
Update QAPP center		Updates the QAPP center.
Export options, multiple selection	User profiles	Selects the user profiles for export and displays the export options.
	Task profiles	Selects the task profiles for export and displays the export options.
	Audit Trail	Selects the audit trail for export and displays the export options.
	Alibi memory	Selects the Alibi memory for export and displays the export options.
	Log file(s)	Selects the log files for export and displays the export options.
Import options, multiple selection	User profiles	Displays the import options for user profiles.
	Task profiles	Displays the import options for task profiles.
Restore factory default settings		Resets the device to factory settings.

8 Operation

8.1 Switching the Device On and Off

The device only delivers accurate values if it has reached the necessary operating temperature. The warm-up time after switching the device on must therefore be complied with.

If the device is being switched on for the first time or if the device is switched on after being reset to factory settings: The Setup Wizard opens. All steps in the Setup Wizard must be completed.

Requirements

The device is connected to the power supply.

Procedure

- ▶ If the device does **not** switch on automatically after it is connected to the power supply: Press the ON key on the weighing module.
- ▶ **NOTICE** Pointed or sharp-edged objects may damage the operating display! Touching the operating display with objects, such as pens, may damage the touchscreen surface of the operating display. Only touch the operating display with your fingertips.
- ▶ If the Setup Wizard is shown: Follow the instructions in the Setup Wizard in the operating display.
- ▶ If the login display is displayed: Log into the device using a user profile.
- ▷ If the device is switched on after the Setup Wizard is complete and **no** passwords have been assigned for the user profiles: The user profile for the last user to be logged in is loaded.
- ▶ To allow the device to reach the necessary operating temperature to accurately determine the weight: Comply with the warm-up time of 30 minutes after switching the device on.
- ▷ If this relates to a conformity-assessed device: The weight value is marked as **invalid** during the warm-up period.
- ▶ To switch the device off: Disconnect the device from the power supply.

M

8.2 Logging Users In and Out

Procedure

- ▶ If the name of the desired user profile is displayed in the entry field (1) of the login display: Press the [Login] button.
- ▶ If the name of the desired user profile is **not** displayed in the entry field of the login display:
 - ▶ Tap on the entry field in the login display.
 - ▷ The user selection opens.
 - ▶ Press the name of the desired user profile.
 - ▶ If a password has been assigned for the desired user: Enter the password in the entry field and press the [OK] button.
 - ▷ The user profile opens and the main menu or the last task being performed by the active user is displayed.
- ▶ To log out the active user profile from the device: Press the [Log-out] button.

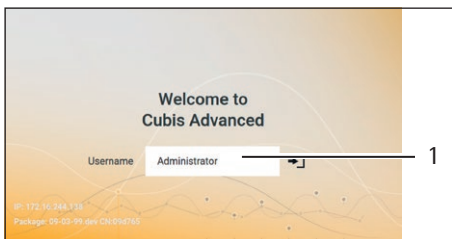

8.3 Leveling the Device

8.3.1 Level Device with Inclination Sensor

Leveling compensates any inclines at the device's installation site. If leveling is necessary: The [Leveling] button appears in the weighing display and a message appears in the Status Center.

Procedure

- ▶ If the weighing display is displayed: Press the [Leveling] button.
- ▶ When the Status Center is displayed: Press the [Level] button.
- ▷ The wizard for leveling with inclination sensor opens.
- ▶ Follow the wizard's instructions.

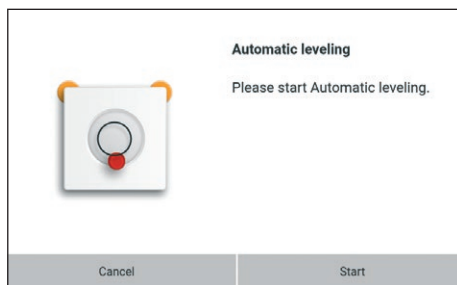

8.4 Activating Applications and Adding a Task

8.4.1 Activating Applications

All applications from the QAPP package "Essentials" are activated for the device at the factory. Additional applications may be activated in the QAPP center.

Procedure

- ▶ Open Task Management.
- ▶ Press the [QAPP center] button.
- ▷ An overview of all available QAPP packages is displayed.
- ▶ Select the desired software application package e.g. pharmaceuticals.
- ▶ To scroll through the contents of a displayed QAPP package: Swipe the contents of the QAPP package upwards or downwards.

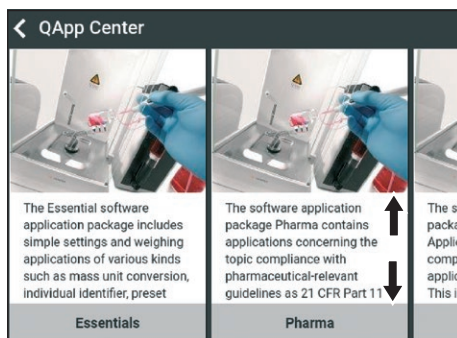

- ▶ Select the desired QAPP package.
- ▷ A list of all the applications contained in the QAPP package is displayed.
- ▶ If the selected QAPP package is to be approved with all the applications it contains or all QAPP packages are to be approved:
 - ▶ Press the [License] button.
 - ▷ The input field for the license key appears.
 - ▶ If an additional cost is associated with the QAPP package: Enter the license key in the entry field and press the [OK] button.
 - ▶ If no additional cost is associated with the QAPP package: Press the [OK] button.

- ▶ If an individual application from the displayed QAPP package is to be activated:
 - ▶ Press the desired application.
 - ▷ A display opens containing details about the selected application.
 - ▶ Press the [License] button.
 - ▷ The input field for the license key appears.
 - ▶ If an additional cost is associated with the application: Enter the license key in the entry field and press the [OK] button.
 - ▶ If no additional cost is associated with the application: Press the [OK] button.

8.4.2 Adding an Application to a Task

Applications must be added to a task so that they can run.

Procedure

- ▶ Open Task Management.
- ▶ Press the [New] button.
- ▷ A list of all activated applications is displayed.
- ▶ To select an application: Press the desired application.
- ▷ The wizard for creating a new task starts.
- ▶ Follow the wizard's instructions in the operating display.

8.5 Adding Print and Weighing Profiles to a Task

To be able to use a print or weighing profile: Add a print or weighing profile to a task.

Procedure

- ▶ Open Task Management.
- ▶ Create or edit a task. In order to do so, start the wizard to create or edit a task and follow the wizard's instructions in the operating display.

8.6 Preparing Weighings

The device must be prepared before every weighing.

Procedure

- ▶ Level the device.
- ▶ Zero the device. In order to do so, press the [Zero] button.
- ▶ If the device **cannot** be zeroed: Remove the sample to be weighed and re-zero the device.
- ▶ Calibrate the device.

8.7 Weighing

NOTICE

Chemicals may damage the device or accessories!

Chemicals can attack the device or the connected accessories internally and externally. This may damage the device and accessories.

- ▶ Use appropriate containers when weighing chemicals.

Procedure

- ▶ Start a task with weighing function.
- ▶ Zero the device. In order to do so, press the [Zero] button.
- ▶ If below-balance weighing is being carried out: Suspend the sample on the hook for below-balance weighing, e.g. with a wire.
- ▶ If a container is being used for the sample:
 - ▶ Place the container on the weighing pan.
 - ▶ Tare the device. In order to do so, press the [Tare] button.
 - ▶ Place the sample in the container or fill the container.
- ▶ If **no** container is used for the sample and **no** below-balance weighing is being carried out: Place the sample on the weighing pan.
- ▶ Once the weight value is displayed in black and the weighing unit is displayed: Read off the measured value.

8.8 Overview of Calibration, Adjustment, and Linearization

During calibration, a calibration weight is used to determine how much the displayed value deviates from the actual value. This deviation is compared against a preset target value. The subsequent adjustment eliminates this deviation. During linearization, the deviation of the values from the ideal characteristic curve is corrected.

Calibration and adjustment must be performed regularly:

- Daily, every time the device is switched on
- After every leveling
- After changing the ambient conditions (temperature, humidity, or air pressure)
- After setting the device up at a new installation site

Calibration and adjustment may be performed in different ways:

- Adjusting with the isoCAL function
- Internal or external calibration or adjustment



Only internal adjustment/calibration is possible for all conformity-assessed devices in legal metrology.

8.9 Adjusting with the isoCAL Function

The device can be automatically internally calibrated and adjusted using the isoCAL function.

Requirements

- The device is **not** located in the menu.
- Alphanumeric inputs are **not** active.
- The load on the weighing pan remains unchanged for 2 minutes.
- The load on the weighing pan amounts to no more than 2% of the maximum load.
- The device does **not** register an input for 2 minutes.

If all requirements for starting the isoCAL function are met and one of the following conditions occurs: The isoCAL function is automatically triggered.

Possible conditions are:

- The ambient temperature has changed since the last adjustment/calibration.
- The interval time was exceeded (interval time, see Chapter "15.9 isoCAL Function", page 71).
- The device has been leveled.
- The device has been disconnected from the power supply since the last adjustment/calibration (only for conformity-assessed models).

Procedure

- ▶ If the isoCAL automatic start function is set and the [isoCAL] button is displayed as the predominant button in the operating display:
 - ▶ Wait until the isoCAL function starts automatically.
 - ▷ In the operating display, a time display counts down to 0.
 - ▷ If **no** load change or **no** operation takes place on the device before the expiration of the time display: The isoCAL function starts.
- ▶ If the isoCAL manual start function is set and the [isoCAL] button is displayed as the predominant button in the operating display:
 - ▶ Press the [isoCAL] button.
 - ▶ If information is displayed stating that the weighing pan is loaded: Unload the weighing pan.
 - ▷ The isoCAL function starts.
- ▷ If the isoCAL function is complete: The device confirms the completion of the calibration/adjustment process with an acoustic signal, and the calibration report is displayed.
- ▶ To close the calibration report and return to the previous display: Press the [OK] button.

8.10 Internally Calibrating and Adjusting the Device

Requirements

The weighing pan is unloaded.

Procedure

- ▶ Open the main menu.
- ▶ Press the "Balance Adjustment" task.
- ▷ The internal calibration/adjustment function is executed.
- ▷ If the calibration/adjustment function is complete: The device confirms the completion of the calibration/adjustment process with an acoustic signal, and the calibration report is displayed.
- ▶ To close the calibration report and return to the main menu: Press the [OK] button.

8.11 Weighing and Printing with ID Marking

8.11.1 Saving Values for Printouts

Every lot and every sample can be assigned an ID number. The ID numbers are saved in the print memory and exported during the printing process.

Requirements

The prompt for the lot IDs and sample IDs is activated for the "Standard weighing" task.

Procedure

- ▶ Open the main menu.
- ▶ Start the "standard weighing" task: In order to do so, tap on the task.
- ▷ The input field for the lot ID is displayed.
- ▶ If a barcode scanner is connected to the device: Enter the lot ID in the entry field or scan using the barcode scanner.
- ▶ If **no** barcode scanner is connected to the device: Type the lot ID into the entry field.
- ▶ Press the [OK] button.
- ▷ The weighing display is displayed.
- ▶ Zero the device. In order to do so, press the [Zero] button.
- ▶ Place the sample on the weighing pan.
- ▶ Press the [Print] button.
- ▷ The input field for the sample ID is displayed.
- ▶ Type the sample ID into the entry field.
- ▶ Press the [OK] button.
- ▷ The [Print memory] button appears in the operating display.
- ▷ The weight value and entered IDs are saved.
- ▶ If additional values are to be saved:
 - ▶ Remove the sample being weighed.
 - ▶ Place the next sample on the weighing pan and press the [Confirm] button.
 - ▶ Type the sample ID into the entry field.
 - ▶ Press the [OK] button.

8.11.2 Marking Saved Values as Invalid

Procedure

- ▶ Press the [Print Memory] button.
- ▷ The print memory opens and a list of all saved values is displayed.
- ▶ Press the [Edit] button.
- ▶ Press the desired items.
- ▷ An overview of all data to be printed is displayed for the selected items.
- ▶ Press the [Cancel] button.
- ▶ If a reason for the invalidity of the value needs to be displayed on the printout: Enter a reason in the entry field and press the [OK] button.
- ▶ If **no** reason for the invalidity of the value needs to be displayed on the printout: Press the [OK] button.

8.11.3 Marking Saved Values as Valid

Procedure

- ▶ Press the [Print Memory] button.
- ▷ The print memory opens and a list of all saved values is displayed.
- ▶ Press the [Edit] button.
- ▶ Press the items which are desired to be marked as invalid.
- ▷ An overview of all data to be printed is displayed for the selected items.
- ▶ Press the [Cancel] button.

8.11.4 Printing Saved Values

Procedure

- ▶ Press the [Print Memory] button.
- ▷ The print memory opens and a list of all saved values is displayed.
- ▶ To start the print process using the print profile embedded in the current task: Press the [Print] button.
- ▷ A PDF file is produced and sent to the printer defined in the print profile.

8.11.5 Exiting the Task

Procedure

- ▶ Press the [Exit] or [Menu] button.
- ▷ If additional values are to be saved in the print memory:
 - ▷ A dialog for prematurely ending the task appears.
 - ▶ To return to the weighing display and print the saved values: Tap on the [Yes] button and print the saved values.
 - ▶ To exit the task and delete the saved values from the print memory: Press the [No] button.
- ▷ The task ends and the main menu is displayed.

8.12 Viewing the Alibi Memory

The Alibi memory stores weight values with date, time, and process number. The content of the Alibi memory can be searched and sorted using a filter. The Alibi memory has a ring buffer. This means that the oldest data records can be overwritten by new ones. The Alibi memory is designed for a specific number of data records (for the number of data records see Chapter "15.10 Alibi Memory", page 72).

The user alone is responsible for making sure that there is sufficient storage capacity and the saved weighed values are present.

M

The Alibi memory is verifiable. The proper functioning of the Alibi memory must be ensured for verification by saving and checking some values.

Procedure

- ▶ Open the "Settings/Device Settings/Device Information" menu.
- ▶ Press the "View Alibi memory" menu entry.
- ▷ A list of all the values saved in the Alibi memory is displayed.
- ▶ If only the values for a desired date need to be displayed:
 - ▶ Press the [Filter] button.
 - ▶ Type the desired date into the entry field.
 - ▶ To filter the list with the date entered: Press the [OK] button.
- ▶ If the list needs to be searched for a particular ID:
 - ▶ Press the [Search] button.
 - ▶ Type the desired ID into the entry field.
 - ▶ To start the search with the entered ID: Press the [OK] button.

8.13 Running Applications (Examples)

8.13.1 Executing the "Toggle Between Weight Units" Function

The "Toggle between weight units" function enables the user to switch between the different units and resolutions defined in the weighing profile of the active task. The units and resolutions can be set at the beginning of the weighing process.

Procedure

- ▶ Start the desired task.
- ▶ Press the [Toggle between weight units] button.
- ▷ All units defined in the weighing profile for the active task are displayed in a list.
- ▷ All resolutions for the weight value defined in the weighing profile for the active task are displayed in a list.
- ▶ Press the desired unit.
- ▶ To set the resolution for the selected unit: Press the desired resolution.
- ▶ To confirm the selection and return to the weighing display: Press the [OK] button.
- ▷ The current weight value is displayed in the selected unit and resolution.

8.13.2 Running the "Statistics" Application

The "Statistics" application saves up to 100 weight values and evaluates these statistically.

The following values are saved and exported by the statistics application:

- Number of components
- Mean value
- Standard deviation
- Variation coefficient
- Sum of all values
- Lowest value (minimum)
- Highest value (maximum)
- Spread: Difference between maximum and minimum

The "Statistics" application can be combined with the following functions:

- Toggle between weight units, only available in the weighing display, before saving the initial weight value
- ID marking
- Automatic taring

Procedure

- ▶ Open the main menu.
- ▶ Start the task for the "Statistics" application.
- ▶ Zero the device.
- ▶ Place the sample on the weighing pan.
- ▶ To start the recording of the statistics: Press the [Confirm] button on the keypad.
- ▷ The current weight value is saved and the device is automatically tared.
- ▶ To save the next value: Place a new sample on the weighing pan and press the [Confirm] button.
- ▶ To display an overview of the saved data: Press the [Report] button.
- ▶ To print the current statistics: Press the [Print] button.
- ▶ To exit the current statistics, and to delete the saved values: Press the [Exit] button.

9 Cleaning and Maintenance

9.1 Preparing the Device

Procedure

- ▶ Turn the device off.
- ▶ Disconnect the device from the power supply. To do so, disconnect the power supply cable from the wall outlet.
- ▶ Remove weighing pan and all associated components from the weighing module, e.g. shield frame, pan support.

9.2 Cleaning the Device

NOTICE

Corrosion or damage to the device due to unsuitable cleaning agents!

- ▶ Do **not** use corrosive, chloride-containing, or aggressive cleaning agents.
 - ▶ Do **not** use cleaning agents that contain abrasive ingredients, e.g. scouring agents, steel wool.
 - ▶ Do **not** use solvent-based cleaning agents.
 - ▶ Check whether the cleaning agents used are compliant materials (see Chapter "15.3 Materials", page 67).
 - ▶ Make sure that cleaning materials, such as cloths, are only slightly damp.
-

Procedure

- ▶ **NOTICE** Malfunction or damage to the device due to the ingress of moisture or dust!
 - ▶ Remove dust and powdery sample residue with a brush or hand-held vacuum cleaner.
- ▶ **NOTICE** Corrosion or damage to the weighing pan due to unsuitable cleaning agents!
 - ▶ Wipe down the weighing pan and the shield frame with a cleaning agent and a cloth. The cleaning agent must be suitable for stainless steel and titanium.
- ▶ Wipe the associated components of the weighing pan with a brush or a damp cleaning cloth, e.g. shield frame, support pan.
- ▶ Wipe the device housing with a damp cloth. For more severe contamination, use a mild soap solution.

Tip

We recommend cleaning the weighing pan on a regular basis, e.g. weekly. Do **not** allow deposits to form on the weighing pan.

Protective oil may be applied to the weighing pan for additional protection. The protective oil must be suitable for stainless steel and titanium.

9.3 Assembling and Connecting the Device

Procedure

- ▶ Replace the weighing pan and the associated components on the weighing module (see Chapter 5.7, page 36).
- ▶ Re-connect the device to the power supply (see Chapter 6.2, page 37).

9.4 Maintenance Schedule

Interval	Component	Action	Chapter, page
Monthly to every 2 years, depending on the operating conditions	Device	Contact Sartorius Service	17, 75

9.5 Performing a Software Update

A software update can be installed from a USB mass storage device using the device's USB-A connection.

Requirements

- The device is switched on.
- The software update is saved on a USB mass storage device.

Procedure

- ▶ Download the software update from the Sartorius website onto the USB mass storage device.
- ▶ If this relates to a zip file: Unzip the software update on the stick.
- ▶ Insert the USB mass storage device with the software update into one of the device's USB-A connection sockets.
- ▶ Select the "Update Firmware" menu entry in the "Settings/Device Maintenance" menu.
- ▷ The software update takes approx. 3 minutes.
- ▷ Once the software update is complete: The software version number is updated in the login display.

9.6 Performing a QAPP Center Update

The QAPP center update can be installed from a USB mass storage device using the device's USB-A connection.

Requirements

- The device is switched on.
- The QAPP center update is saved on a USB mass storage device.

Procedure

- ▶ Download the QAPP center update from the Sartorius website onto the USB mass storage device.
- ▶ If this relates to a zip file: Unzip the QAPP center update on the stick.
- ▶ Insert the USB mass storage device with the QAPP center update into one of the device's USB-A connections.
- ▶ Select the "QAPP Center Update" menu entry in the "Settings/Device Maintenance" menu.
- ▶ Tap on the desired update.
- ▶ Once the software update is complete: Confirm successful installation with the [OK] button.

10 Malfunctions

10.1 Warning Messages

Warning message	Fault	Cause	Remedy	Chapter, page
Disp.Err.	The value to be output cannot be shown in the operating display.	The data to be displayed is not compatible with the set display format.	Adjust the display settings in the menu, e.g. resolution, unit, decimal places.	
High	The device is overloaded.	The device's maximum weighing capacity has been exceeded.	Reduce the applied weight to below the device's maximum weighing capacity.	15.7, 69
Low	The modulation of the weighing converter inside the weighing module is too low.	No weighing pan has been placed on the balance. A previously forgotten weight was removed after starting the device.	Insert the weighing pan into the device and switch the device off and on again.	
Com.Err.	The device is not receiving any weight values.	No communication exists between the display and control unit and the weighing module.	Wait until the display and control unit restores the communication with the weighing module. If the problem occurs again: Contact Sartorius Service.	17, 75

10.2 Troubleshooting

Fault	Cause	Remedy	Chapter, page
The operating display is blank.	The device is disconnected.	Check the connection to the power supply.	6.2, 37
	The AC adapter is not connected.	Connect the power supply cable to the power supply.	6.2, 37
The displayed weight value changes constantly.	The installation site is unstable.	Adjust the parameters in the "Environment Monitoring" Submenu. Change the installation site.	7.4.3, 42 5.2, 32
	A foreign object is positioned between the weighing pan and the housing.	Remove the foreign object.	
	The device was not calibrated.	Calibrate the device.	8.8, 53
The weight readout displayed by the device is obviously wrong.	The device was not tared before weighing.	Tare the device.	

11 Decommissioning

11.1 Decommissioning the Device

Procedure

- ▶ Turn the device off.
- ▶ Disconnect the device from the power supply.
- ▶ Disconnect the device from all connected devices and all accessories, e.g. printer.
- ▶ Clean the device (see Chapter 9.2, page 59).
- ▶ If below-balance weighing has been set up:
 - ▶ Turn over the device and place on a soft surface.
 - ▶ Remove the hook for below-balance weighing from the thread.
 - ▶ Insert below-balance cap (1) back into the opening (2) in the device base and screw in with a suitable screwdriver.
 - ▶ Place the device on the device base on a level surface.

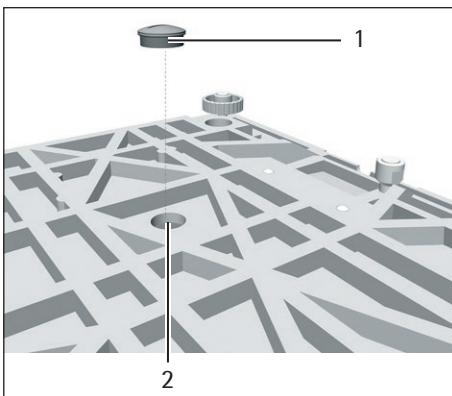

12 Transport

12.1 Transporting the Device

Procedure

- ▶ Only lift the device by its base.

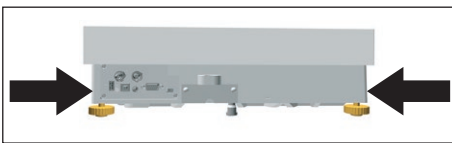

- ▶ When lifting and transporting, ensure that **no** personnel or objects are in the way.
- ▶ Get help from additional persons when lifting and transporting the device.
- ▶ Use suitable conveyance devices, e.g. trolleys, for long transport routes.

13 Storage and Shipping

13.1 Storage

Procedure

- ▶ Turn the device off.
- ▶ Disconnect the device from the power supply.
- ▶ Disconnect the device from all connected devices and all accessories, e.g. printer.
- ▶ Clean the device (see Chapter 9.2, page 59).
- ▶ Store the device according to the ambient conditions (see Chapter 15.6, page 68).

13.2 Returning Device and Parts

Defective devices or device components can be returned to Sartorius. Returned devices must be clean, decontaminated, and properly packed, e.g. in the original packaging.

Transport damage as well as measures for subsequent cleaning and disinfection of the device or device components by Sartorius shall be charged to the sender.

WARNING

Risk of injury due to contaminated devices!

Devices contaminated with hazardous materials [nuclear, biological, or chemical (NBC)] will **not** be accepted for repair or disposal.

- ▶ Observe the information on decontamination (see Chapter 14.1, page 65).
-

Procedure

- ▶ Disconnect the device from the power supply.
- ▶ Disconnect the device from all connected devices and all accessories, e.g. printer.
- ▶ Clean the device.
- ▶ Contact Sartorius Service for instructions on how to return devices or device components (please refer to www.sartorius.com for return instructions).
- ▶ Pack the device and the device components properly for return, e.g. in the original packaging.

14 Disposal

14.1 Information on Decontamination

The device does **not** contain any hazardous materials that would necessitate special disposal actions.

Contaminated samples used during the process are potentially hazardous materials that could cause biological or chemical hazards.

If the device has come into contact with hazardous substances: Steps must be taken to ensure proper decontamination and declaration. The operator is responsible for adhering to local government regulations on the proper declaration of transport and disposal and the proper disposal of the device.

WARNING

Risk of injury due to contaminated devices!

Devices contaminated with hazardous materials (NBC contamination) will **not** be accepted by Sartorius for repair or disposal.

14.2 Disposing of Device and Parts

14.2.1 Information on Disposal

The device and the device accessories must be disposed of properly by disposal facilities.

A lithium cell battery, type CR2032, is installed inside the device. Batteries must be disposed of properly by disposal facilities.

The packaging is made of environmentally friendly materials that can be used as secondary raw materials.

14.2.2 Disposal

Requirements

The device has been decontaminated.

Procedure

- ▶ Dispose of the device. Follow the disposal instructions on our website (www.sartorius.com).
- ▶ Inform the disposal facility that there is a lithium cell battery, type CR2032, installed inside the device.
- ▶ Dispose of the packaging in accordance with local government regulations.

15 Technical Data

15.1 Dimensions and Weight

15.1.1 High-capacity Precision Balance

		With rectangular weighing pan	With round weighing pan
	Unit	Value	Value
Dimensions (L × W × H)	mm	444 x 400 x 126	444 x 400 x 159
Weighing pan size	mm	400 x 300	∅ 233
Weight, approx.	kg	15.8	17.1

15.2 Power Supply

15.2.1 Device

Only by Sartorius AC adapter YEPS03-15V0

15.2.2 Power Supply Unit

	Unit	Value
Item No.		YEPS03-15V0
Primary		
AC voltage	V	100–240 (±10%)
Frequency	Hz	50–60 (±5%)
Current consumption, maximum	A	1.0
Secondary		
DC voltage at 2 A output current	V	14.25–15.75
Power, maximum	W	30
Short circuit protection: Electronic		
Protection class according to IEC 62368-1		I
Pollution level according to IEC 61010-1		2
Overvoltage category according to IEC 606641-1		II
Installation site according to IEC 62368-1, maximum altitude above sea level	m	5000
Temperature		
In operation	°C	0 – +40
During storage and transport	°C	-20 – +80
Connector for mains connection according to IEC 60320-1/C14: 3-pin		
Power supply cable		
Power supply cable according to IEC 60320-1/C14: Country-specific, 3-pin, two-sided plug		
Other data: See label on AC adapter		

15.2.3 Safety of Electrical Equipment

According to EN 61010-1/IEC 61010-1 Safety requirements for electrical equipment for measurement, control, and laboratory use – Part 1: General Requirements

15.2.4 Electromagnetic Compatibility

Interference resistance

Suitable for use in industrial areas

Transient emissions

Class B

Suitable for use in residential areas and areas that are connected to a low voltage network that also supplies residential buildings.

15.3 Materials

Housing: Die-cast aluminum and stainless steel 1.4401 | 1.4404

Control unit: Die-cast aluminum, painted, float glass and plastic PBT, PP

15.4 Integrated Clock

	Unit	Value
Maximum deviation per month (RTC)	s	30

15.5 Backup Battery

	Unit	Value
Lithium battery, type CR2032		
Service life at room temperature, minimum	Years	10

15.6 Ambient Conditions

15.6.1 Installation Site

	Unit	Value
Installation site		
Standard laboratory rooms		
Installation site according to IEC 60259-1, maximum altitude above sea level	m	3000
For indoor use only		
Temperature		
In operation	°C	+5 – +40
In operation for conformity-assessed devices: See information on the device's ID plate		
During storage and transport	°C	-20 – +60
Relative humidity		
At temperatures of up to 31 °C	%	80
Then linear decrease from 80 % at 31 °C to 50 % at 40 °C		
No heat from heating systems or direct sunlight		
No drafts from open windows, AC systems, or doors		
No vibrations		
No "heavy traffic" areas (personnel)		
No electromagnetic fields		
No dry air		

15.6.2 Ambient temperature for the isoCAL function

	Unit	Value
Scope of application as per Directive 2014/31/EU		
With isoCAL function	°C	+10 – +30
Without isoCAL function	°C	+10 – +30

15.6.3 Protection Class

	Value
IP protection according to IEC 60529-1	IP 54

15.7 Metrological Data

15.7.1 Models MCA32202P | MCA70201S | MCA50201S | MCA36201S

		MCA32202P	MCA70201S	MCA50201S	MCA36201S
	Unit	Value	Value	Value	Value
Scale interval (d)	g	0.01 0.1	0.1	0.1	0.1
Maximum capacity (Max)	g	4200 32200	70200	50200	36200
Repeatability at 5 % load					
Standard deviation of the load values, tolerance	g	0.04	0.1	0.1	0.1
Standard deviation of the load values, typical value	g	0.02	0.04	0.04	0.02
Repeatability at approx. maximum capacity					
Standard deviation of the load values, tolerance	g	0.1	0.1	0.1	0.1
Standard deviation of the load values, typical value	g	0.02	0.04	0.04	0.02
Linearity deviation					
Tolerance	g	0.05 0.2	0.5	0.5	0.2
Typical value	g	0.05 0.1	0.15	0.15	0.1
Deviation when load is off-center, positions according to OIML R76					
Test weight	g	10000	20000	20000	10000
Tolerance	g	0.2	0.5	0.5	0.3
Typical value	g	0.1	0.3	0.3	0.2
Sensitivity drift between +10 °C and +30 °C	ppm/K	2	2	2	2
Tare maximum capacity: Less than 100 % of maximum capacity					
Accuracy class according to Directive 2014/31/EU		-	II	II	II
Verification scale interval (e) according to Directive 2014/31/EU	g	-	1	1	1
Minimum load (Min) according to Directive 2014/31/EU	g	-	5	5	5
Minimum initial weighing according to USP (United States Pharmacopeia), Chap. 41					
Optimum minimum initial weighing	g	8.2	82	82	82
Typical minimum initial weighing	g	8.2	82	82	82
Typical stabilization time	s	2	1.5	1.5	1.5
Typical measurement time	s	2	1.5	1.5	2

15.7.2 Models MCA36201P | MCA20201S | MCA11201S | MCA70200S | MCA36200S

		MCA36201P	MCA20201S	MCA11201S	MCA70200S	MCA36200S
	Unit	Value	Value	Value	Value	Value
Scale interval (d)	g	0.1 1	0.1	0.1	1	1
Maximum capacity (Max)	g	10200 36200	20200	11200	70200	36200
Repeatability at 5 % load						
Standard deviation of the load values, tolerance	g	0.1	0.1	0.1	0.5	0.5
Standard deviation of the load values, typical value	g	0.02	0.02	0.02	0.2	0.2
Repeatability at approx. maximum capacity						
Standard deviation of the load values, tolerance	g	0.1	0.1	0.1	0.5	0.5
Standard deviation of the load values, typical value	g	0.02	0.02	0.02	0.2	0.2
Linearity deviation						
Tolerance	g	0.2	0.2	0.2	1	1
Typical value	g	0.1	0.06	0.06	0.2	0.2
Deviation when load is off-center, positions according to OIML R76						
Test weight	g	10000	5000	5000	20000	10000
Tolerance	g	0.3	0.3	0.3	1	1
Typical value	g	0.2	0.2	0.2	0.6	0.5
Sensitivity drift between +10 °C and +30 °C	ppm/K	2	2	2	3	3
Tare maximum capacity: Less than 100 % of maximum capacity						
Accuracy class according to Directive 2014/31/EU		II	II	II	II	II
Verification scale interval (e) according to Directive 2014/31/EU	g	1	1	1	10	1
Minimum load (Min) according to Directive 2014/31/EU	g	5	5	5	50	50
Minimum initial weighing according to USP (United States Pharmacopeia), Chap. 41						
Optimum minimum initial weighing	g	82	82	82	820	820
Typical minimum initial weighing	g	82	82	82	820	820
Typical stabilization time	s	1.5	1.5	1.5	1	1
Typical measurement time	s	2	2	2	1.2	1.2

15.8 Recommended Calibration Weight

		MCA32202P	MCA70201S	MCA50201S	MCA36201S
	Unit	Value	Value	Value	Value
External test weight	kg	30	70	50	30
Recommended accuracy class		F1	F1	F1	F1

		MCA36201P	MCA20201S	MCA11201S	MCA70200S
	Unit	Value	Value	Value	Value
External test weight	kg	30	20	10	70
Recommended accuracy class		F1	F1	F1	F1

		MCA36200S
	Unit	Value
External test weight	kg	30
Recommended accuracy class		F1

15.9 isoCAL Function

15.9.1 Models MCA32202P | MCA70201S | MCA50201S | MCA70200S

	Unit	Value
isoCAL is triggered by the following criteria:		
In the event of a temperature change	K	2
After a time interval	h	12
After successful leveling		

M With conformity-assessed devices, isoCAL **cannot** be turned off.

15.9.2 Models MCA36201S | MCA36201P | MCA20201S | MCA11201S | MCA36200S

	Unit	Value
isoCAL is triggered by the following criteria:		
In the event of a temperature change	K	4
After a time interval	h	12
After successful leveling		

15.10 Alibi Memory

	Value
Maximum number of data records	150000

15.11 Interfaces

15.11.1 Specifications for the COM-RS232 Interface

Type of interface: Serial interface

Interface operation: Full duplex

Level: RS232

Connection: D-sub connector, 9-pin

Pin assignment

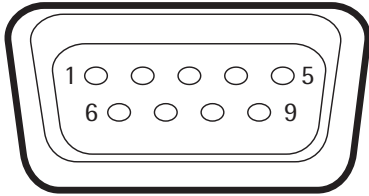

Pin 1: **Not** assigned
 Pin 2: Data output (TxD)
 Pin 3: Data input (RxD)
 Pin 4: **Not** assigned
 Pin 5: Internal ground
 Pin 6: **Not** assigned
 Pin 7: Clear to Send (CTS)
 Pin 8: Request to Send (RTS)
 Pin 9: **Not** assigned

15.11.2 Specifications for the USB-A Interface

Communication: USB host (master)

Connectable devices: Sartorius printers, USB sticks with software update

15.11.3 Specifications for the USB-B Interface

Communication: USB device (slave)

Type of interface: Virtual serial interface (virtual COM-port, VCP) and "PC direct" communication

16 Accessories

16.1 Accessories

This table contains an excerpt of the accessories that can be ordered. For information on other products, contact Sartorius.

16.1.1 Printers and Communication

Item	Quantity	Order number
Thermal transfer thermal printer for GLP/GMP printouts on continuous paper and labels	1	YDP30
Standard paper and ink ribbon, set, 90 m, for YDP30	1	69Y03285
Self-adhesive paper and ink ribbon, 90 m, for YDP30	1	69Y03286
Standard thermal paper, 24 m roll, for YDP30 YDP40	5	69Y03287
Self-adhesive thermal paper, 13 m roll, for YDP30	5	69Y03288
Self-adhesive labels for YDP30		
58 mm × 100 mm	350	69Y03094
58 mm × 76 mm	500	69Y03093
58 mm × 30 mm	1000	69Y03092
Display cable, 3 m, for separate installation of display and weighing units, installation by Sartorius Service or at the factory (order code VF4016)	1	On request
Installation of display cable, 3 m, for separate installation of display and weighing units	1	VF4016
RS232C connection cable, 9-pin, 3 m, for connection to a PC with 9-pin COM interface	1	On request
Sartorius Wedge, software for data communication between the PC and balance	1	YSW02

16.1.2 Displays and Input/Output Elements

Item	Quantity	Order number
Display and control unit with color TFT display, touch screen, and keys	1	YAC01MCE
Motion sensor for triggering a maximum of 4 functions via gesture control, selection via menu	1	YHS02MS

16.1.3 Weighing Tables

Item	Quantity	Order number
Weighing table		
Made from synthetic stone, with vibration dampening	1	YWT03
Made from wood and synthetic stone	1	YWT09
Wall console	1	YWT04

16.1.4 Weighing Accessories

Item	Quantity	Order number
Weighing scoop made from chrome-nickel steel, L 90 mm x W 32 mm x H 8 mm	1	641214
Stand		
For weighing modules with scale intervals of 10 mg 100 mg for raising the control units	1	YDH03MS
For weighing modules with scale intervals of 100 mg 1 g and weighing capacity of > 20 kg for raising the control units	1	YDH04MS
Hook for below-balance weighing for precision weighing modules with scale intervals of 100 mg 1 g and weighing capacity > 20 kg, not suitable for conformity-assessed devices	1	69EA0040

17 Sartorius Service

Sartorius Service is available for queries regarding the device. For information about the service addresses, services provided, or to contact a local representative, please visit the Sartorius website (www.sartorius.com).

When contacting Sartorius Service with questions about the system or in the event of malfunctions, be sure to have the device information, e.g. serial number, hardware, firmware, and configuration, to hand. Consult the information on the manufacturer's ID label and in the "General Device Information" menu (see Chapter "4.14 Menu Structure", page 26).

18 Conformity and Certificates

18.1 EU Declaration of Conformity

The attached Declaration of Conformity hereby confirms compliance of the device with the directives cited.

M The declaration of conformity supplied here is for conformity-assessed (verified) balances for use in the EEA. Please keep it in a safe place.



Original



sartorius

EG-/EU-Konformitätserklärung EC / EU Declaration of Conformity

Hersteller
Manufacturer Sartorius Lab Instruments GmbH & Co. KG
37070 Goettingen, Germany

erklärt in alleiniger Verantwortung, dass das Betriebsmittel
declares under sole responsibility that the equipment

Geräteart
Device type Elektronische Präzisions-, Milligramm-, Analysen-, Semimikro-, Mikro-Klein- und Hochlastwaage
Electronical Precision, Milligram, Analytical, Semi micro, Micro-Small, and High-Capacity Balance

Baureihe
Type series MCAvw-2x-y, MCEvw-2x-y,
v = 2.7, 3.6, 6.6, 10.6, 124, 125, 224, 225, 323, 324, 524, 623, 1202, 1203, 2202, 2203, 3203, 4202,
5201, 5202, 5203, 6202, 8201, 8202, 10202, 11201, 12201, 14202, 20201, 32202, 36200, 36201,
50201, 70200, 70201;
w = S, P; x = S00, S01, CEU, CFR, CCN, OBR, OIN, ORU, OJP; y = A, E, F, I, M, O, R, U

in der von uns in Verkehr gebrachten Ausführung allen einschlägigen Bestimmungen der folgenden Europäischen Richtlinien - einschließlich deren zum Zeitpunkt der Erklärung geltenden Änderungen - entspricht und die anwendbaren Anforderungen folgender harmonisierter Europäischer Normen erfüllt:
in the form as delivered fulfils all the relevant provisions of the following European Directives - including any amendments valid at the time this declaration was signed - and meets the applicable requirements of the harmonized European Standards listed below:

2014/30/EU Elektromagnetische Verträglichkeit
Electromagnetic compatibility
EN 61326-1:2013

2006/42/EG
2006/42/EC Maschinen
Machines
EN ISO 12100:2010, EN 61010-1:2010

2011/65/EU Beschränkung der Verwendung bestimmter gefährlicher Stoffe in Elektro- und Elektronikgeräten (RoHS)
Restriction of the use of certain hazardous substances in electrical and electronic equipment (RoHS)
EN 50581:2012

Die Person, die bevollmächtigt ist, die technischen Unterlagen zusammenzustellen:
The person authorised to compile the technical file: Sartorius Lab Instruments GmbH & Co. KG
International Certification Management
37070 Goettingen, Germany

Jahreszahl der CE-Kennzeichenvergabe | *Year of the CE mark assignment:* 18

Sartorius Lab Instruments GmbH & Co. KG
Goettingen, 2018-06-20

Dr. Reinhard Baumfalk
Vice President R&D

Dr. Dieter Klausgrete
Head of International Certification Management

Diese Erklärung bescheinigt die Übereinstimmung mit den genannten EG- und EU-Richtlinien, ist jedoch keine Zusicherung von Eigenschaften. Bei einer mit uns nicht abgestimmten Änderung des Produktes verliert diese Erklärung ihre Gültigkeit. Die Sicherheitshinweise der zugehörigen Produktdokumentation sind zu beachten.

This declaration certifies conformity with the above mentioned EC and EU Directives, but does not guarantee product attributes. Unauthorised product modifications make this declaration invalid. The safety information in the associated product documentation must be observed.



Certificate: 70185847
Project: 70185847

Master Contract: 167555
Date Issued: 2018-09-24

APPLICABLE REQUIREMENTS

CSA Standards:

CAN/CSA-C22.2 No. 61010-1-12 - Safety Requirements for Electrical Equipment for Measurement, Control, and Laboratory Use, Part 1: General Requirements

UL Standards:

UL Std. No. 61010-1 (3rd Edition) - Safety Requirements for Electrical Equipment for Measurement, Control, and Laboratory Use - Part 1: General Requirements

CONDITIONS OF ACCEPTABILITY

- (1) Equipment is intended to be used with power supply FSP Group Inc, Model FSP030-DGAN3 or Sinpro Electronics Co Ltd, Model SPU31-106 or PSFD rated output 15Vdc, 2A. The equipment can also be used with any other power supply approved for Canada and USA under the 60950-1 or 61010-1 or equivalent standards and which provides Reinforced insulation between mains and secondary circuits. It must be rated for 3000m and up to 40°C and must provide an output of 15Vdc LPS with a minimum of 1A
- (2) Detachable cord set, to be delivered with the product, consisting of minimum NEMA 5-15 Plug, 3 x 18AWG cable and C13 Appliance coupler. For countries outside Canada and the USA the cable must be equivalent and must fulfill the national requirements for detachable cord sets.

18.3 FCC Supplier's Declaration of Conformity

FCC Supplier's Declaration of Conformity

Device type Electronical Precision, Milligram, Analytical, Semi Micro, Micro-Small and High-Capacity Balance

Type series **MCAvw-2x-y, MCEvw-2x-y**

v = 2.7, 3.6, 6.6, 10.6, 124, 125, 224, 225, 323, 324, 524, 623, 1202, 1203, 2202, 2203, 3203, 4202, 5201, 5202, 5203, 6202, 8201, 8202, 10202, 11201, 12201, 14202, 20201, 32202, 36200, 36201, 50201, 70200, 70201

w = S, P

x = S00, S01, CEU, CFR, CCN, OBR, OIN, ORU, OJP

y = A, E, F, I, M, O, R, U

**Party issuing Supplier's Declaration of Conformity /
Responsible Party – U.S. Contact Information**

Sartorius Corporation
5 Orville Dr Suite 200
11716 Bohemia, NY
USA
Telephone: +1.631.254.4249

FCC Compliance Statement

This device complies with Part 15 of the FCC Rules. Operation is subject to the following two conditions: (1) This device may not cause harmful interference, and (2) this device must accept any interference received, including interference that may cause undesired operation.

Information to the user

Note: This equipment has been tested and found to comply with the limits for a **class B** digital device, pursuant to part 15 of the FCC Rules. These limits are designed to provide reasonable protection against harmful interference in a residential installation. This equipment generates, uses and can radiate radio frequency energy and if not installed and used in accordance with the instructions, may cause harmful interference to radio communications. However, there is no guarantee that interference will not occur in a particular installation. If this equipment does cause harmful interference to radio or television reception, which can be determined by turning the equipment off and on, the user is encouraged to try to correct the interference by one or more of the following measures:

- Reorient or relocate the receiving antenna.
- Increase the separation between the equipment and receiver.
- Connect the equipment into an outlet on a circuit different from that to which the receiver is connected.
- Consult the dealer or an experienced radio/TV technician for help.

Connections between the device and peripherals must be made using shielded cables in order to maintain compliance with FCC radio frequency emission limits.

Any modifications made to this device that are not approved by Sartorius may void the authority granted to the user by the FCC to operate this equipment.

Sartorius Stedim Systems GmbH
Robert-Bosch-Strasse 5-7
34302 Guxhagen, Germany

Phone: +49.5665.407.0
www.sartorius.com

The information and figures contained in these instructions correspond to the version date specified below.

Sartorius reserves the right to make changes to the technology, features, specifications and design of the equipment without notice.

Masculine or feminine forms are used to facilitate legibility in these instructions and always simultaneously denote the other gender as well.

Copyright notice:

This instruction manual, including all of its components, is protected by copyright. Any use beyond the limits of the copyright law is not permitted without our approval. This applies in particular to reprinting, translation and editing irrespective of the type of media used.

© Sartorius Germany

Last updated:
08 | 2018