

Operating Instructions
Original Operating Instructions

Cubis[®]

MCE Models
Precision Balances



Contents

1 About these Instructions	5	7 System Settings	28
1.1 Scope	5	7.1 Performing System Settings.....	28
1.2 Symbols Used.....	5	7.2 Switching Off the isoCAL Function.....	28
1.2.1 Warnings in Operating Instructions.....	5	7.3 Parameter List	29
1.2.2 Other Symbols	5	7.3.1 Parameters in the "Setup" Main Menu	29
1.3 Target Groups.....	6	7.3.2 Parameters in the "Device" Main Menu....	31
2 Safety Instructions	7	7.3.3 Parameters in the "Data Output" Main Menu.....	34
2.1 Intended Use	7	7.3.4 Parameters in the "Applications" Main Menu.....	35
2.2 Personnel Qualification.....	7	7.3.5 Parameters in the "Input" Main Menu....	38
2.3 Significance of these Instructions.....	7	7.3.6 Parameters in the "Language" Main Menu.....	38
2.4 Proper Working Order of the Device.....	8	7.3.7 Parameters in the "Unit 1", "Unit 2", "Unit 3", and "Unit 4" Function Menus....	38
2.5 Symbols on the Device	8	8 Operation	39
2.6 Electrical Equipment.....	8	8.1 Switching the Device On and Off	39
2.6.1 Damage to the Electrical Equipment of the Device	8	8.2 Leveling the Device.....	39
2.6.2 Working on the Device's Electrical Equipment.....	8	8.2.1 Leveling the Device with the Level.....	39
2.6.3 AC Adapter and Power Supply Cable.....	8	8.2.2 Leveling a Device with Manual Feet with Inclination Sensor	40
2.7 Conduct in an Emergency.....	8	8.3 Preparing Weighings.....	40
2.8 Accessories, Consumables, and Spare Parts	9	8.4 Weighing	41
2.9 Personal Protective Equipment	9	8.5 Overview of Calibration, and Adjustment.....	41
2.10 Glass Breakage.....	9	8.6 Adjusting with the isoCAL Function	41
3 Device Description	10	8.7 Internally Calibrating and Adjusting the Device ...	42
3.1 Device Overview	10	8.8 Externally Calibrating and Adjusting the Device (Not for Conformity-assessed Models)	43
3.2 Weighing Pan and Associated Components.....	11	8.9 Printing Results	45
3.3 Connections and Components on the Weighing Module	11	8.10 Weighing and Printing with ID Marking.....	45
3.4 Connections on the Control Unit.....	12	8.11 Running Applications (Examples)	46
3.5 Conformity-assessed Devices.....	12	8.11.1 Executing the "Toggle Between Weight Units" Function.....	46
3.6 Symbols on the Device	12	8.11.2 Running the "Statistics" Application.....	46
4 Operating Concept	13	9 Cleaning and Maintenance	48
4.1 Operating Display in Weighing Mode.....	13	9.1 Preparing the Device.....	48
4.2 Operating Display in the Menu	14	9.2 Cleaning the Device	48
4.3 Buttons and Keys on the Operating Display.....	14	9.3 Assembling and Connecting the Device	49
4.4 Displays in the Operating Display	15	9.4 Maintenance Schedule	49
4.5 Menu Structure.....	17	9.5 Performing a Software Update	49
4.5.1 Overview of the Device Settings Menu	17	10 Malfunctions	50
4.6 Navigating the Menus.....	21	10.1 Status Messages.....	50
5 Installation	23	10.2 Warning Messages.....	50
5.1 Scope of Delivery.....	23	10.3 Troubleshooting.....	52
5.2 Selecting an Installation Site.....	23	11 Decommissioning	53
5.3 Unpacking the Device.....	24	11.1 Decommissioning the Device.....	53
5.4 Removing the Control Unit	24	12 Transport	53
5.5 Preparing Below-cell Weighing.....	25	12.1 Transporting the Device	53
5.6 Positioning the Weighing Pan and Associated Components.....	26		
5.7 Acclimatization	26		
6 Getting Started	27		
6.1 Connecting Electronic Components	27		
6.2 Installing the AC Adapter.....	27		
6.3 Connecting the Power Supply	27		

13 Storage and Shipping	54	15.8 Recommended Calibration Weight	62
13.1 Storage	54	15.9 isoCAL Function	62
13.2 Returning Device and Parts	54	15.9.1 Models MCE14202S MCE14202P MCE10202S	62
14 Disposal	55	15.9.2 Models MCE8202S MCE6202S MCE6202P MCE4202S MCE2202S MCE1202S	62
14.1 Information on Decontamination	55	15.9.3 Models MCE12201S MCE8201S MCE5201S	62
14.2 Dispose of Device and Parts	55	15.10 Interfaces	63
14.2.1 Information on Disposal	55	15.10.1 Specifications for the COM-RS232 Interface	63
14.2.2 Disposal	55	15.10.2 Specifications for the USB-A Interface	63
15 Technical Data	56	15.10.3 Specifications for the USB-B Interface	63
15.1 Dimensions and Weight	56	16 Accessories	64
15.1.1 Precision Balance	56	16.1 Accessories	64
15.2 Power Supply	56	16.1.1 Printers and Communication	64
15.2.1 Device	56	16.1.2 Displays and Input/Output Elements	64
15.2.2 Power Supply Unit	56	16.1.3 Special Applications	65
15.2.3 Safety of Electrical Equipment	57	16.1.4 Weighing Tables	65
15.2.4 Electromagnetic Compatibility	57	16.1.5 Weighing Accessories	65
15.3 Materials	57	17 Sartorius Service	66
15.4 Integrated Clock	57	18 Conformity & Certificates	66
15.5 Backup Battery	57	18.1 EU Declaration of Conformity	66
15.6 Ambient Conditions	58	18.2 Certificate of Compliance	68
15.6.1 Installation Site	58	18.3 FCC Supplier's Declaration of Conformity	70
15.6.2 Ambient Temperature for the isoCAL Function	58		
15.6.3 Protection Class	59		
15.7 Metrological Data	59		
15.7.1 Models MCE14202S MCE14202P MCE10202S MCE8202S	59		
15.7.2 Models MCE6202S MCE6202P MCE4202S MCE2202S	60		
15.7.3 Models MCE1202S MCE12201S MCE8201S MCE5201S	61		

1 About these Instructions

1.1 Scope

These instructions are part of the device. These instructions apply to the device in the following versions:

Device	Model
Cubis® precision balance	MCE10202S-... MCE1202S-...
	MCE12201S-... MCE14202P-...
	MCE14202S-... MCE2202S-...
	MCE4202S-... MCE5201S-...
	MCE6202P-... MCE6202S-...
	MCE8201S-... MCE8202S-...

1.2 Symbols Used

1.2.1 Warnings in Operating Instructions

WARNING

Denotes a danger with the risk that death or severe injury may result if it is **not** avoided.



CAUTION

Denotes a hazard that may result in moderate or minor injury if it is **not** avoided.

NOTICE

Denotes a danger with the risk that property damage may result if it is **not** avoided.

1.2.2 Other Symbols

-  Required action: Describes actions which must be carried out.
-  Result: Describes the result of the actions carried out.
- [] Text inside brackets refers to control and display items.
- [] Text inside brackets indicates status, warning, and error messages.
-  Indicates information for legal metrology for conformity-assessed (verified) devices. Conformity-assessed devices are also referred to as "verified" in these instructions.

Figures on the Operating Display

The figures on the operating display of the device may deviate from those in these instructions.

1.3 Target Groups

These instructions are addressed to the following target groups. The target groups must possess the specified knowledge.

Target group	Knowledge and responsibilities
---------------------	---------------------------------------

User	The user is familiar with the operation of the device and the associated work processes. They understand the hazards which may arise when working with the device and know how to prevent them. They have been trained in the operation of the device. The training is carried out by the operating engineer/laboratory manager or the operator of the device.
Operator	The operator of the device is responsible for compliance with safety requirements and workplace safety regulations. The operator must ensure that all persons who work with the device have access to the relevant information and are trained in working with the device.

2 Safety Instructions

2.1 Intended Use

The device is a high-resolution balance, which can be used in laboratories. The device was developed for the accurate determination of the mass of materials in liquid, paste, powder, or solid form.

Appropriate containers must be used for loading each type of material. The device can be used in stand-alone operation or can be operated on a PC.

The device is exclusively designed for use according to these instructions. Any further use beyond this is considered **improper**.

If the device is **not** used properly: The protective systems of the device may be impaired. This can lead to unforeseeable personal injury or property damage.

Operating Conditions for the Device

Do **not** use the device in potentially explosive environments. The device may only be used indoors.

The device may only be used with the equipment and under the operating conditions described in the Technical Data section of these instructions.

Modifications to the Device

You may **not** modify or repair the device or make any technical changes. Any retrofitting or technical changes to the device are only permitted with prior written permission from Sartorius.

2.2 Personnel Qualification

All persons working on the device must possess the necessary knowledge and responsibilities (see Chapter "1.3 Target Groups", page 6).

If **no** qualifications are indicated for the actions described in these instructions: The actions described are addressed to the "User" target group.

If individual actions must be carried out by other target groups or by Sartorius Service personnel: The qualification required will be indicated in the description of the action.

2.3 Significance of these Instructions

Failure to follow the instructions in this manual can have serious consequences, e.g., exposure of individuals to electrical, mechanical, or chemical hazards.

- ▶ Before working with the device: Read the instructions carefully and completely.
- ▶ If these instructions are lost: Request a replacement or download the latest version from the Sartorius website (www.sartorius.com).
- ▶ Ensure that the information contained in these instructions is available to all individuals working on the device.

2.4 Proper Working Order of the Device

A damaged device or worn parts may lead to malfunctions or cause hazards which are difficult to recognize.

- ▶ Only operate the device when it is safe and in perfect working order.
- ▶ Have any malfunctions or damage repaired immediately by Sartorius Service.

2.5 Symbols on the Device

All symbols appearing on the device, such as warnings and safety labels, must be legible.

- ▶ Do **not** conceal, remove, or modify the symbols.
- ▶ Replace the symbols if they become illegible.

2.6 Electrical Equipment

2.6.1 Damage to the Electrical Equipment of the Device

Damage to the electrical equipment of the device, e.g. damage to the insulation, can be life-threatening. Contact with parts under voltage represents a direct danger to life.

- ▶ If the device's electrical equipment is defective, disconnect the device from the power supply and contact Sartorius Service.
- ▶ Keep live parts away from moisture. Moisture can cause short circuits.

2.6.2 Working on the Device's Electrical Equipment

Only Sartorius Service personnel may work on or modify the electrical equipment of the device. The device may only be opened by Sartorius Service personnel.

2.6.3 AC Adapter and Power Supply Cable

Serious injury can result, e.g. from electric shocks, if an unsuitable and inadequately dimensioned power supply cable or unsuitable power supply is used.

- ▶ Only use the original power supply cable and power supply.
- ▶ If the power supply or power supply cable must be replaced: Contact Sartorius Service. Do **not** repair or modify the power supply or power supply cable.

2.7 Conduct in an Emergency

If there is immediate danger of personal injury or if there is a risk of damage to the device, e.g., due to malfunctions or dangerous situations, the device must be immediately taken out of operation.

- ▶ Disconnect the device from the power supply cable by disconnecting the power supply cable.
- ▶ Malfunctions should be remedied by Sartorius Service.

2.8 Accessories, Consumables, and Spare Parts

The use of unsuitable accessories, consumables, and spare parts can affect the functionality and safety of the device and have the following consequences:

- Risk of injury to persons
 - Damage to the device
 - Malfunction of the device
 - Device failure
-
- ▶ Only use approved accessories, consumables, and spare parts supplied by Sartorius. Information on operational quality is available upon request from Sartorius.
 - ▶ Only use accessories, consumables, and spare parts that are in proper working order.

2.9 Personal Protective Equipment

Personal protective equipment protects against risks arising from the samples used.

- ▶ If the workplace or the measurement process in which the device is being used requires personal protective equipment: Wear personal protective equipment.

2.10 Glass Breakage

Glass components can break if they fall or are handled incorrectly. Glass fragments can cause cuts.

- ▶ Only lift the device by its base, **not** by the draft shield.
- ▶ When lifting and transporting, ensure that **no** personnel or objects are in the way.

3 Device Description

3.1 Device Overview

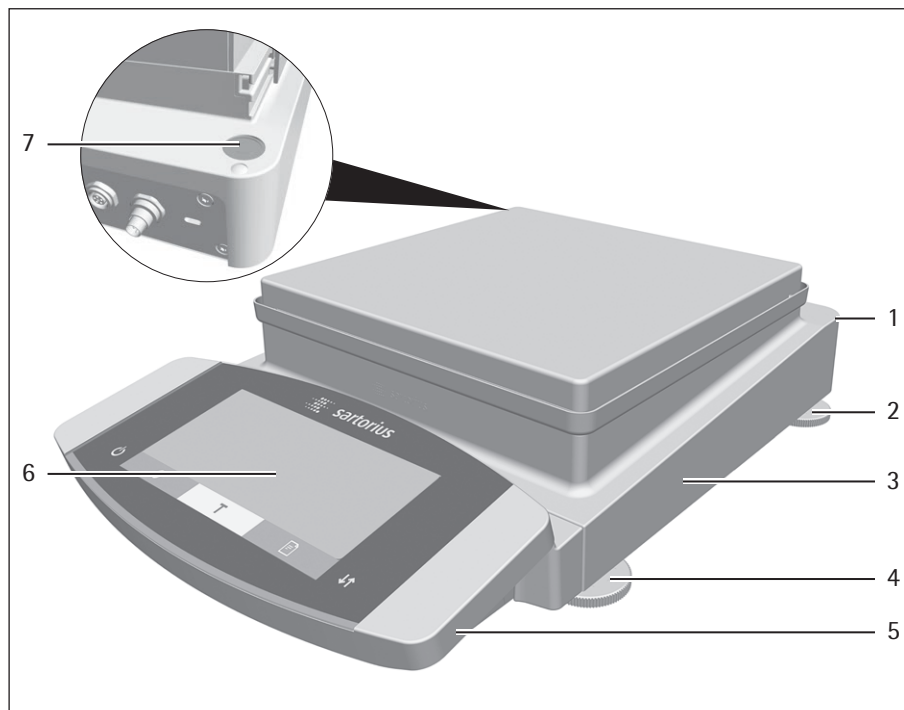

Fig. 1: Precision balance (example)

Pos.	Designation	Description
1	Manufacturer's ID label	Not depicted
2	Leveling foot	Depending on the model: Not adjustable, is screwed in for leveling.
3	Weighing module	
4	Leveling foot	Motorically or manually adjustable
5	Control unit	
6	Operating display	Touchscreen
7	Level	

3.2 Weighing Pan and Associated Components

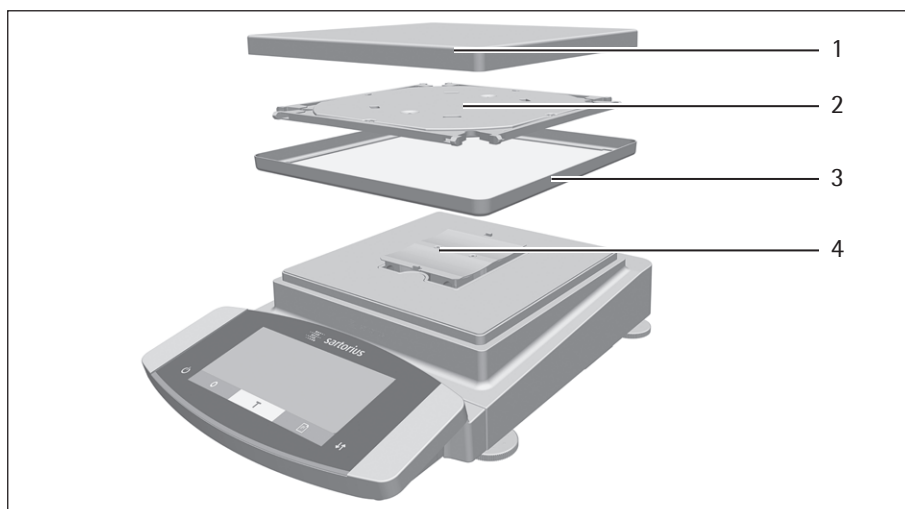

Fig.2: Precision balance (example)

Pos.	Designation
1	Weighing pan
2	Pan support
3	Shield disk
4	Pan retainer

3.3 Connections and Components on the Weighing Module

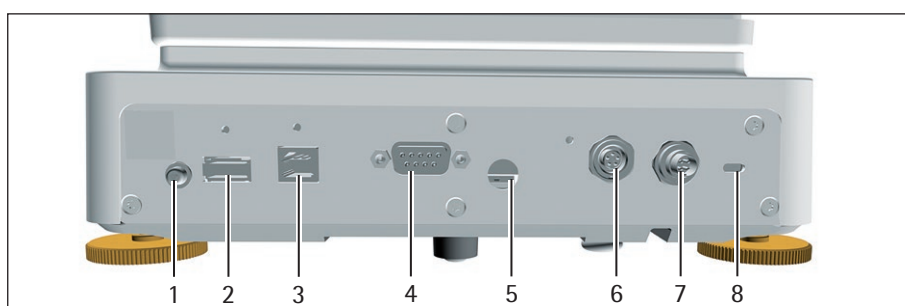

Fig.3: Connections for weighing module

Pos.	Designation	Description
1	On key	
2	USB-A connection	For printers and for software updates via a USB mass storage device
3	USB-B connection	For connection to a PC
4	COM-RS232 connection	9-pin, for connection to a PC or PLC
5	Access switch	Protects the device from changes to the device settings. Is sealed for conformity-assessed devices.
6	Peripheral connection	For connecting Sartorius accessories
7	Power supply	For connection to the power supply
8	Slot	For attaching a "Kensington" anti-theft device

3.4 Connections on the Control Unit

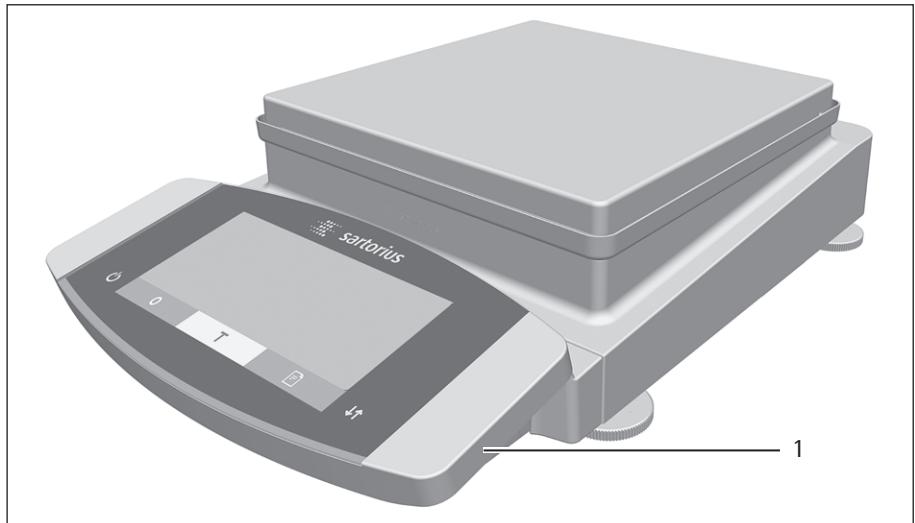

Fig. 4: Connections on the control unit

Pos.	Designation	Description
1	USB connection	Concealed, no function, for Sartorius Service only

3.5 Conformity-assessed Devices

Some settings of conformity-assessed models are protected against user changes, e.g. external calibration for devices in accuracy class II. This measure is intended to ensure the suitability of the devices for use in legal metrology.

3.6 Symbols on the Device



Fig. 5: ID label on the device

Pos.	Designation	Description
1	Manufacturer's ID label	Displays the metrological data of the device.

Symbol	Meaning
	During operation, parts in the device may be live. Only electricians may have access to and work on these parts, such as for maintenance and repairs.

4 Operating Concept

4.1 Operating Display in Weighing Mode

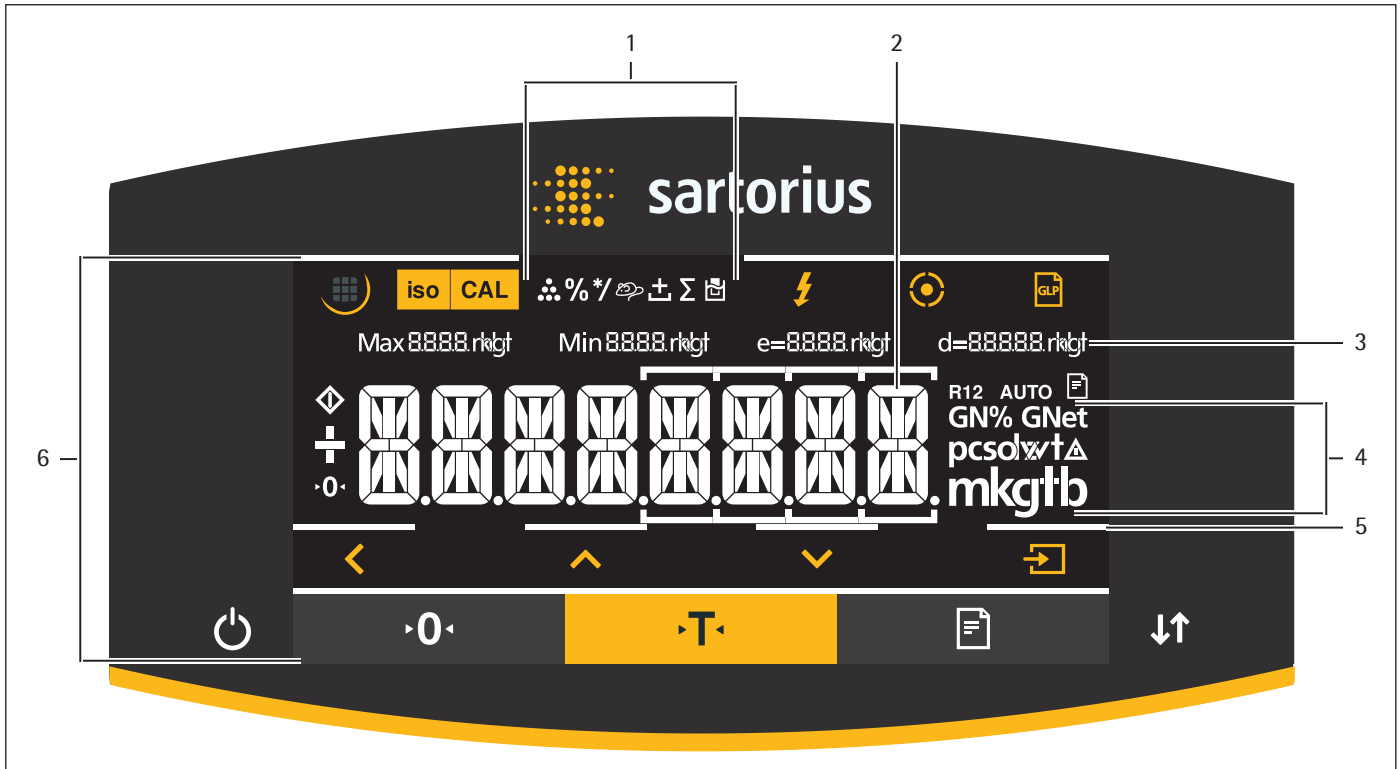

Fig. 1: Operating display in weighing mode (example)

Pos.	Designation	Description
1	Symbols for the selected application	
2	Weight value display	In the selected basic unit.
3	Metrological data	
4	Weight units	Shows the selected basic unit, e.g. grams, [g].
5	Visual touch-feedback	Visual note on an active button or key.
6	Operating and display area	

4.2 Operating Display in the Menu

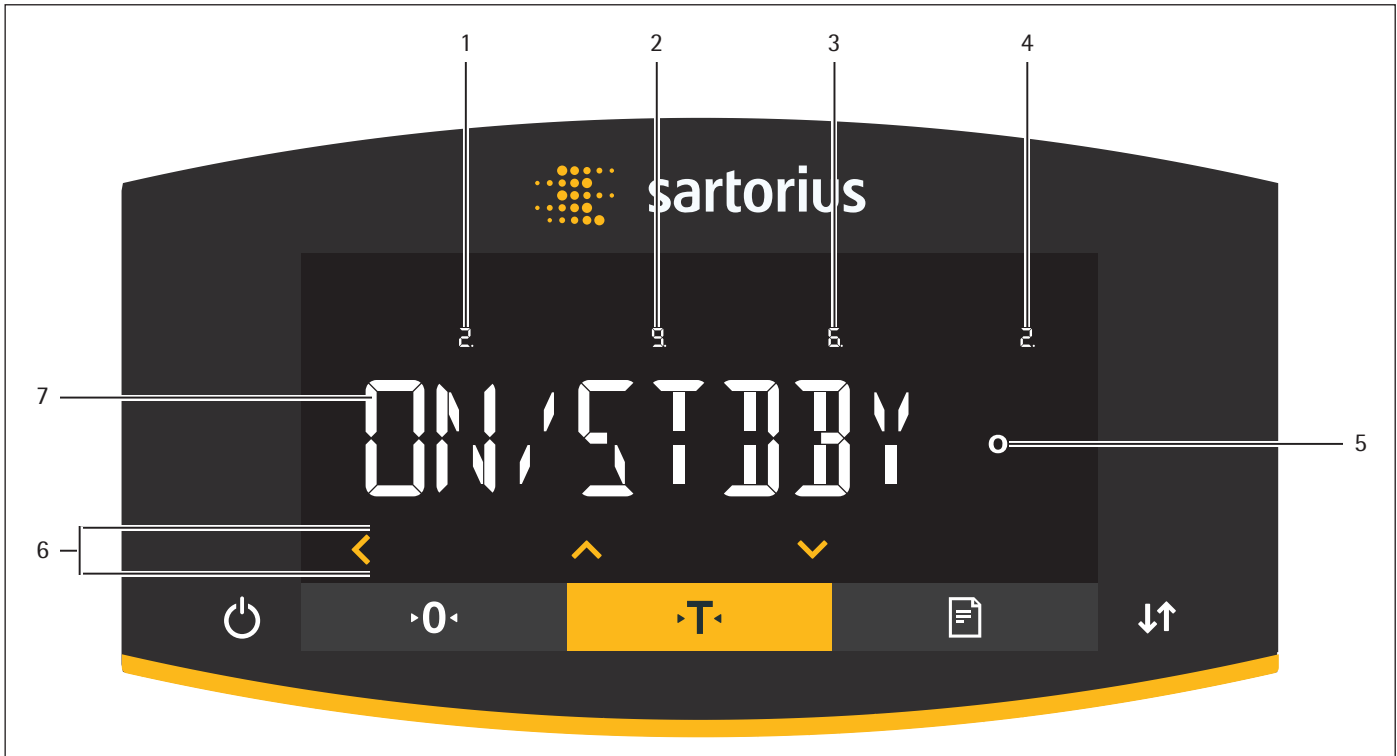













Fig. 2: Operating display in the menu (example)



Pos.	Designation	Description
1	Position in the 1st menu level	Shows the position of the displayed menu or configuration value in up to 4 menu levels.
2	Position in the 2nd menu level	
3	Position in the 3rd menu level	
4	Position in the 4th menu level	
5	[Computed values] display	Note on the set menu item
6	Operating area	
7	Name of the menu or setting	







4.3 Buttons and Keys on the Operating Display

Pos.	Symbol	Designation	Description
1		[Menu] button	When the button is pressed: The settings menu opens. If the button is held down: It switches to version display.
2		[isoCAL] button	Starts the isoCAL function.
3		[Adjust] button	Starts the set calibration and adjustment function.
4		[Ionizer] button	Starts an ionization process.
5		[Leveling] button	Starts a leveling process.
6		[GLP] button	<ul style="list-style-type: none"> Exits the GLP printout and starts printing the GLP footer. If the "Net-total", "Totalizing", or "Statistics" application is active: Prints and deletes the saved values and exits the application.

Pos.	Symbol	Designation	Description
7		[Toggle between weight units] button	If the "Toggle between weight units" function is active: <ul style="list-style-type: none"> – If the button is held down: Accesses the "Toggle between weight units" function menu. – When the button is pressed: Switches between the basic unit display and up to 4 other units.
8		[Invalid weight value] button	If a fault exists in the weighing module: Indicates the cause of this fault.
9		[Back] button	<ul style="list-style-type: none"> – In the menu: <ul style="list-style-type: none"> – When the button is pressed: Returns to the previous display. – If the button is held down: Saves the menu settings. – When entering digits: Selects the previous digit position. – For an active application: Exits the application and deletes the set reference value.
10		[Up] button	<ul style="list-style-type: none"> – In the menu: Scrolls through the menu levels or the available configuration values. – When entering digits: Increases the displayed value.
11		[Down] button	<ul style="list-style-type: none"> – In the menu: Scrolls through the menu levels or the available configuration values. – When entering digits: Decreases the displayed value. – In the main display of an active application: Accesses the display to set the reference values.
12		[Confirm] button	<ul style="list-style-type: none"> – In the menu: Accesses the displayed menu level or confirms the displayed configuration value. – When entering digits: Selects the next digit position. – In the main display of an active application: Starts the application process and saves the set reference value.
13		[On/Off] key	If the key is briefly pressed: Switches the operating display on. If the key is held down: Switches the operating display off.
14		[Zero] key	Zeros the device.
15		[Tare] key	Starts taring.
16		[Print] key	Exports the readouts to the integrated data interfaces.
17		[Change] key	<ul style="list-style-type: none"> – For models without a motorized draft shield, if the "Toggle between weight units" function is active: <ul style="list-style-type: none"> – If the key is briefly pressed: Switches between the set weight units. – If the key is held down: Accesses the "Toggle between weight units" function menu.

4.4 Displays in the Operating Display

Pos.	Symbol	Designation	Description
1		[Leveling] display	<ul style="list-style-type: none"> – Indicates that the device is leveled. – If the center circle is flashing: Indicates that the device is not leveled.
2		[Leveling] display	Flashes while the device is leveling.
3		[Counting] display	Indicates that the "Counting" application is selected.

Pos.	Symbol	Designation	Description
4		[Weighing in percent] display	Indicates that the "Weighing in percent" application is selected.
5		[Calculation] display	Indicates that the "Calculation" application is selected.
6		[Animal weighing] display	Indicates that the "Animal weighing" application is selected.
7		[Net-total] display	Indicates that the "Net-total" application is selected.
8		[Totalizing] display	Indicates that the "Totalizing" application is selected.
9		[Density determination] display	Indicates that the "Density determination" application is selected.
10		[Statistics] display	Indicates that the "Statistics" application is selected.
11		[Busy] display	Indicates that the device is processing a command.
12		[Sign] display	Indicates whether the value being displayed is positive or negative.
13		[Zero] display	For some conformity-assessed devices: Indicates that the device has been zeroed.
14	AUTO	[AUTO] display	Indicates that the "Animal weighing" application starts automatically.
15		[Data output] display	Indicates that the data output is active.
16		[Percent] display	Indicates that a percentage value is being displayed.
17	Net	[Net] display	Indicates that a net value is being displayed.
18		[Computed value] display	<ul style="list-style-type: none"> – In the menu: Identifies the selected configuration value. – If the "Calculation" or "Density determination" application is active: Indicates that a calculated value is being displayed.
19		[Unit symbol] display	Indicates the set weight unit, e.g. [g] for "grams".
20	pcs	[Quantity]	Indicates that a quantity is being displayed.
21		[Invalid weight value] display	<ul style="list-style-type: none"> – Indicates that the display does not contain a weight value, rather it is the calculated result of an application, e.g. for the "Totalizing" application. – For conformity-assessed devices: Indicates a fault. The cause of this fault is displayed after pressing the [Change] key.
22		[Directional arrows] display	If leveling with the inclination sensor is active: Displays the direction of rotation of the leveling foot.

4.5 Menu Structure

4.5.1 Overview of the Device Settings Menu

► Navigating in Menus (see Chapter 4.6, page 21).

Level 1	Level 2	Level 3	Description	
SETUP	BALANCE	AMBIENT "Ambient conditions"	Enter the ambient conditions at the device's installation site.	
		APP FILT. "Application filter"	Equalize the load deviations in the display. The load deviations occur between the complete placement of the sample on the weighing pan and reaching the final result display.	
		STABIL. "Stability range"	Define the accuracy of the stability range. If the weight unit symbol appears, the weight readout is stable within the range indicated by the stability range	
		ST.DEL. "Stability delay"	Define the duration of the stability delay. The stability delay is used to bridge residual fluctuations in the vibration of the device in order to display reliable results.	
		ZERO/TAR. "Zeroing and taring"	Define the trigger for zeroing and taring.	
		AUTOZER. "Auto zero"	Activate/deactivate automatic control of the zero display. The deviations of a set fraction of scale intervals per second starting from the display zero point are automatically zeroed.	
		UNIT	Define the weight unit, e.g. grams, kilograms, pounds. Depending on the country-specific model version, not all weight units listed may be available. Some weight units may be blocked from use in conformity-assessed devices, depending on national verification laws.	
		DISP.DIG.	Define whether all decimal places are displayed. A lower display accuracy enables a faster display. The setting option is not available on conformity-assessed devices.	
		CAL./ADJ. "Adjust"	Define the function of the [Adjust] button.	
		CAL.SEQ. "Calibration sequence"	Define the sequence of the "Calibrate and adjust" function.	
		ON Z/T Tare/zero at power on	Activate/deactivate automatic taring when starting the device.	
		ISOCAL	Configure the isoCAL function.	
		CAL.UNIT "Calibration weight unit"	Define the weight unit for the calibration weight.	
		GEN.SERV. "General services"	MEN.RESET "Menu reset"	Reset the menu to factory settings.

Level 1	Level 2	Level 3	Description
DEVICE	RS-232 "COM-RS232, 9-pin"	DAT.REC.	Set the communication protocol for the connected device.
		BAUD	Set the baud rate for the connected device.
		PARITY	Set the parity for the connected device.
		STOPBIT	Set the number of stop bits.
		HANDSHK.	Set the handshake between the balance and the device.
		DATABIT	Set the number of data bits.
	PC-USB "USB-B (Device/Slave)"	DAT.REC.	Set the communication protocol for the connected PC.
		BAUD	Set the baud rate for the connected PC.
		PARITY	Set the parity for the connected PC.
		STOPBIT	Set the number of stop bits.
		HANDSHK.	Set the handshake between the device and the connected PC.
		DATABIT	Set the number of data bits.
	USB "USB-A (Host/Master)"	DEV.USED "Device in use"	Display the device connected via USB-A.
	LEVELING "Leveling"	LEVEL	Define the settings for the integrated inclination sensor.
		START	Define the trigger for automatic leveling.
	MOTION.S. "Motion sensor"	CONTROL	Activate/deactivate the motion sensor.
		NUM.GEST. "Number"	Define the number of possible gestures.
		LEFT.CMD.	Define the function for the left gesture.
		RIGHT.CMD.	Define the function for the right gesture.
		UP.CMD.	Define the function for the up gesture.
		DOWN.CMD.	Define the function for the down gesture.
EXTRAS	MENU	Lock or unlock the menu's configuration parameters.	
	SIGNAL	Set or deactivate the acoustic signal.	
	KEYS	Activate/deactivate the key lock.	
	ON MODE "Switch-on and switch-off options"	Configure the device's switch-on and switch-off options, e.g. switch between standby mode and operating mode.	
	LIGHTING	Activate/deactivate the lighting for the operating display.	
DATA.OUTP. "Data output"	COM. SBI "SBI communication"	COM.OUTP.	Configure the automatic data output.
		STOP.AUTO	Define whether the automatic data output can be stopped and started with the [Print] key.
		AUTO.CYCL. "Time-dependent interval"	<ul style="list-style-type: none"> – Define an interval for the automatic data output. – Define whether data output takes place after an interval with or without balance stability.
		FORMAT	Define the data output format (characters per line).
		AUTO.TARE	Activate/deactivate automatic taring after the printout.

Level 1	Level 2	Level 3	Description
	PRNT.PARA. "Printout settings"	ACTIVATE "Triggers"	Define whether a printout is triggered via a software command or using the [Print] key.
		FORMAT	Define the format for the printout (characters per line).
		PRT.INIT. "Initializing"	Define the settings for printer initialization.
		GLP	Define the settings for the GLP printout.
		TAR./PRT. "Tare/print"	Activate/deactivate automatic taring after every print process.
		TIME	Define the time format.
		DATE	Define the date display format.
		PC.DIRECT Direct transfer of data (PC)	DEC.SEPAR.
OUTP.FORM.	Define the output format for the data exchange between the balance and the PC.		
APPLIC. "Applications"	WEIGH (Factory setting)	UNIT	Activate/deactivate the "Toggle between weight units" function for all applications.
		COUNT	RESOLUT.
	PERCENT "Weighing in percent"	REF.UPDT. "Reference updating"	Activate/deactivate automatic reference updating for the "Counting" application.
		DEC.PLCS "Decimal places"	Define the number of decimal places for the "Weighing in percent" application.
	NET-TOTL. "Net-total"	COMP.PRT. "Component printout"	Activate/deactivate the component printout for the "Net-total" application.
	TOTAL "Totalizing"	COMP.PRT. "Component printout"	Activate/deactivate the component printout for the "Totalizing" application.
	ANIMALW. "Animal weighing"	ACTIVITY "Animal activity"	Define the level of activity of the sample for the "Animal weighing" application.
		START	Define the trigger for starting the animal weighing.
	CALC. "Calculation"	METHOD	Define the method of calculation for the "Calculation" application.
		DEC.PLCS "Decimal places"	Define the number of decimal places for the "Calculation" application.
	DENSITY "Density determination"	DEC.PLCS "Decimal places"	Define the number of decimal places for the "Density determination" application.
	STATIST. "Statistics"	COMP.PRT. "Component printout"	Activate/deactivate the component printout for the "Statistics" application.
		TAR./STAT. "Tare/statistics"	Activate/deactivate automatic taring for the "Statistics" application.
UPDATE		Start a firmware update. The menu is only available if a USB mass storage device is connected.	

Level 1	Level 2	Level 3	Description
INPUT	ID NO.		Save the entered ID number for the device.
	LOT ID		Activates/deactivates the printout of a line for the LOT ID in the GLP printout. The LOT ID can be entered in the line manually.
	DATE		Set the date.
	TIME		Set the time.
	USER.PASS.		Set the user password.
	DEL.PASS.		Delete the user password. The menu is only available if a user password is set.
	SERV.PASS.		Activate the service mode.
	CAL.WT. "Calibration weight"		Define the value of the external user calibration weight.
INFO "Device information"	VERSION "Version number"		Display the software version number.
	SER. NO. "Serial number"		Display the device's serial number.
	MODEL		Display the device's model ID.
	APC VER.		Display the version of the APC processor.
	BAC VER.		Display the version of the BAC processor.
	MCU VER.		Display the version of the MCU processor.
LANGUAGE			Change the menu language.

Overview of the "Toggle between weight units" Function

- ▶ Navigating in Menus (see Chapter 4.6, page 21).

Level 1	Description
Unit 1	Define the displayed weight unit and the resolution for the 1st convertible unit.
Unit 2	Define the displayed weight unit and the resolution for the 2nd convertible unit.
Unit 3	Define the displayed weight unit and the resolution for the 3rd convertible unit.
Unit 4	Define the displayed weight unit and the resolution for the 4th convertible unit.

4.6 Navigating the Menus

Procedure



- ▶ To access the settings menu: Press the [Menu] button.



- ▶ To scroll through all menus in the same level: Press the [Up] or [Down] button.



- ▶ To switch to the displayed menu level: Press the [Confirm] button on the keypad.
- ▶ To scroll through the configuration values: Press the [Up] or [Down] button.
- ▶ To select the configuration value shown in the display or the displayed application: Press the [Confirm] button on the keypad.



- ▶ The [Value] display identifies the selected configuration value or the selected application.



- ▶ To return to the next higher menu level: Press the [Back] button.
- ▶ To exit the settings menu: In the main menu level, press the [Back] button.

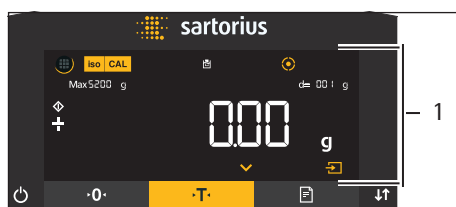

- ▶ If the start display (1) of a selected application is displayed:
 - ▶ To start the application without changing the preset reference value: Press the [Confirm] button on the keypad.
 - ▶ To change a reference value before starting the application, e.g. density value, divisor or reference quantity: Press the [Up] button.
 - ▶ The reference value display is shown for the selected application.

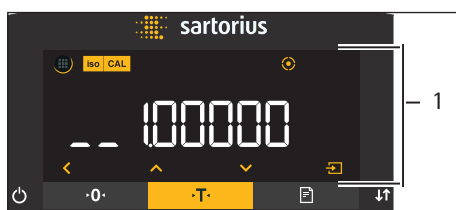

- ▶ If a reference value with decimal places needs to be selected in the reference value display (1) of a selected application, e.g. "Density determination" or "Calculation" applications:
 - ▶ The selected digit position flashes.
 - ▶ Use the [Up] or [Down] button to change the value for the selected digit position.
 - ▶ If a digit position other than the last digit position is selected: Press the [Confirm] button to select the next digit position.
 - ▶ If a digit position other than the first digit position is selected: Press the [Back] button to select the previous digit position.
 - ▶ If the last digit position is selected: Press the [Confirm] button to save the displayed reference value and start the application process.
 - ▶ If the first digit position is selected: Press the [Back] button to delete the displayed reference value and return to the application's status display.

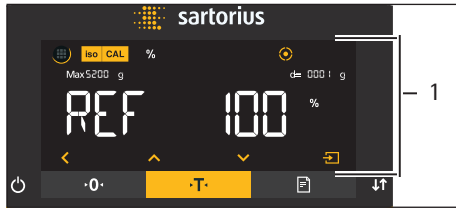

▶ If an integer reference value needs to be selected in the reference value display (1) of a selected application, e.g. "Weighing in percent" or "Animal weighing" applications:

- ▶ Press the [Up] or [Down] button. This increases or decreases the reference value by 1.
- ▶ Hold down the [Up] or [Down] button. This increases or decreases the reference value by 10.
- ▶ To start the application: Press the [Confirm] button on the keypad.
- ▶ To delete the displayed reference value and return to the application's status display: Press the [Back] button.



▶ If the results display (1) of a selected application is displayed:

- ▶ To switch between the application results display and the set reference value display: Press the [Up] or [Down] button.
- ▶ To exit the results, display and delete the set reference value and the result of the application: Press the [Back] button.

5 Installation

5.1 Scope of Delivery

Item	Quantity
Device	1
Weighing pan	1
Shield plate	1
Pan support	1
Power supply unit	1
Country-specific power supply cable with test seal	1
USB connection cable	1
In-use dust cover for control unit	1
In-use dust cover for the weighing module	1

5.2 Selecting an Installation Site

Procedure

- Ensure that the following conditions are met at the installation site:

Condition	Features
Ambient conditions	Suitability tested (see Chapter "15.6 Ambient Conditions", page 58)
Setup surface	<p>Stable, even surface that is not exposed to vibrations</p> <p>Not directly against a wall</p> <p>Sufficiently dimensioned for the device and the peripheral devices (device space requirements see Chapter "15.1 Dimensions and Weight", page 56; peripheral device space requirements see instructions for the peripheral devices, e.g. printer)</p> <p>Sufficient load-bearing capacity for the device and the peripheral devices even when full (device weight see Chapter "15.1 Dimensions and Weight", page 56; weight of the peripheral devices see instructions for the peripheral devices, e.g. printer)</p>
Access	Barrier-free

5.3 Unpacking the Device

Procedure

- ▶ Unpack the device at the intended installation location.
- ▶ Lift the device in the Styrofoam padding out of the packaging.
- ▶ Place the device in the Styrofoam padding on its side.
- ▶ Lift the Styrofoam padding off the device.
- ▶ Place the device on its base.
- ▶ Keep all parts of the original packaging, e.g. to return the device.

5.4 Removing the Control Unit

The control unit can be removed for all models. This enables the flexible setup of the control unit at the workplace.

Tool: 1 Torx Allen key, T20

Material: 1 soft support base

Requirements

The weighing pan and all associated components are **not** placed on the device, e.g. shield ring, pan support.

Procedure

- ▶ Turn over the device and place on a soft surface.

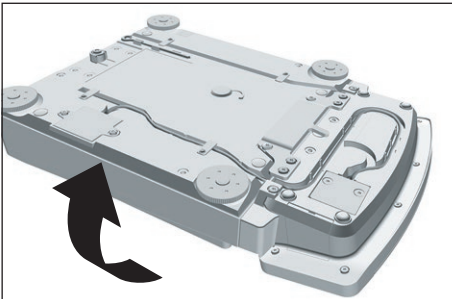

- ▶ To loosen the control unit's retainer: Use the Torx Allen key to remove both screws.
- ▶ Remove the control unit and re-insert both screws into the threaded holes.

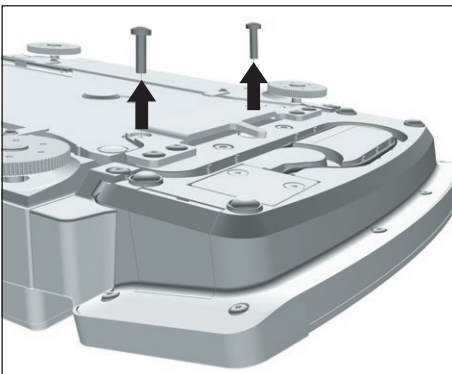

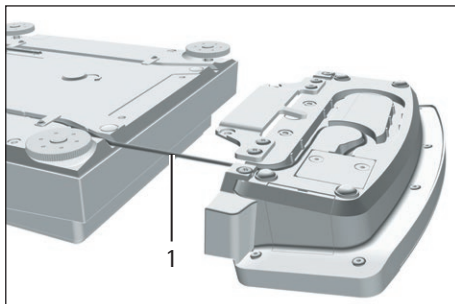

- ▶ Carefully pull the connection cable between the control unit and the weighing module (1) out of the control unit's retainer and unroll it.

- ▶ Turn the device over again and place it on an even surface.

5.5 Preparing Below-cell Weighing

Samples that **cannot** be placed on the weighing pan can be mounted to the device base and weighed using the below-cell weighing equipment.

M

In legal metrology:

- Do **not** use the below-cell weighing equipment.
- Do **not** open the cover of the below-cell weighing equipment.

Material: 1 soft support base

Requirements

The weighing pan and all associated components are **not** placed on the device, e.g. shield ring, pan support.

Procedure

- ▶ Turn over the device and place on a soft surface.

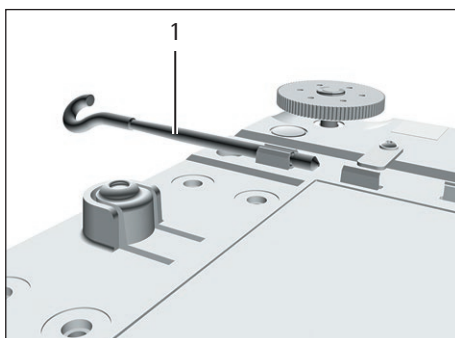
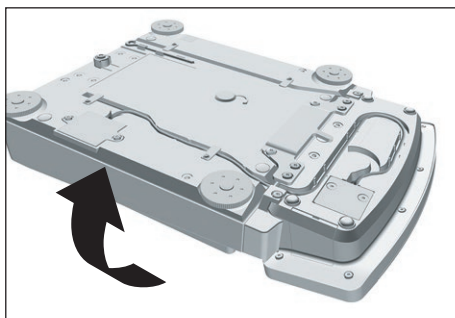

- ▶ Remove the hook for below-balance weighing (1) from the retainer on the underside of the base of the device.

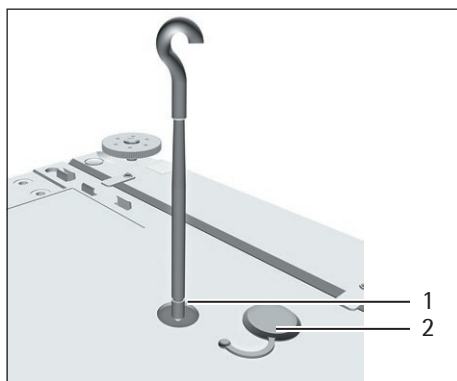

- ▶ Pull the cover of the below-balance weighing equipment out.
- ▶ **NOTICE** Damage to the device from cross-threading! Ensure that the hook for below-balance weighing is inserted straight into the thread opening (1).

- ▶ Install a draft protection shield.
- ▶ Suspend the sample on the hook for below-balance weighing, e.g. with a wire.
- ▶ To cover the below-balance weighing equipment after weighing:
 - ▶ Remove the hook for below-balance weighing from the thread.
 - ▶ Return the hook for below-balance weighing to its retainer on the underside of the weighing module.
 - ▶ Re-insert the cover of the below-balance weighing equipment.

5.6 Positioning the Weighing Pan and Associated Components

Procedure

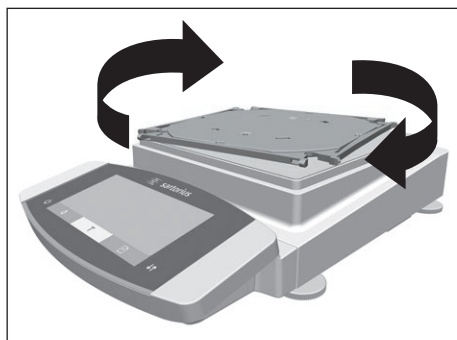

- ▶ Position the pan support down onto retainer, diagonally to the weighing module, and press slightly.
- ▶ Carefully turn the pan support clockwise until the two buttons engage.
- ▶ The pan support is now attached.

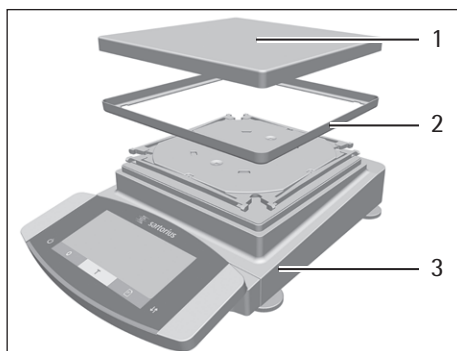

- ▶ Place the shield plate (2) on the weighing module (3).
- ▶ Place the weighing pan (1) on the pan support.

5.7 Acclimatization

When a cold device is brought into a warmer area: The temperature difference can lead to condensation of humidity in the device (moisture formation). Moisture in the device can lead to malfunctions.

- ▶ Allow the device to acclimatize for approx. 2 hours at the installation site. Ensure that the device is disconnected from the power supply during that time.

6 Getting Started

6.1 Connecting Electronic Components

Procedure

- ▶ **NOTICE** Improper connection may damage the device! If the device is connected using electronic components, e.g. printer, PC: The device must be disconnected from the power supply. Ensure that the device is disconnected from the power supply.
- ▶ Connect the device using electronic components (see electronic components instructions).

6.2 Installing the AC Adapter

Procedure

- ▶ Plug the DC supply cable of the AC adapter into the device's "power supply" connection socket and tighten the threaded fitting.

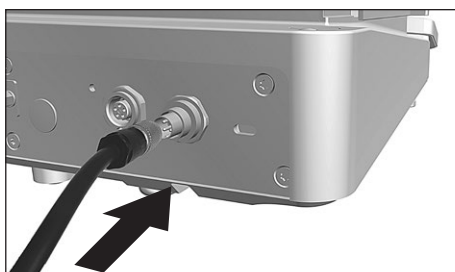

- ▶ Connect the power supply cable to the AC adapter connection.

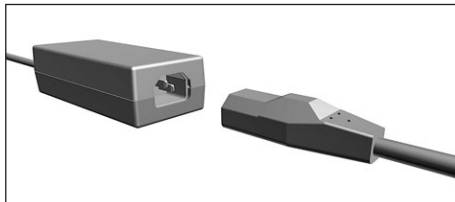

6.3 Connecting the Power Supply

Procedure

- ▶ **⚠ WARNING** Severe injuries caused by using a defective power supply cable! Check the power supply cable for damage, e.g., cracks in the insulation.
 - ▶ If required: Contact Sartorius Service.
- ▶ Check whether the country-specific power plug matches the power connections at the installation site.
 - ▶ If required: Contact Sartorius Service.
- ▶ **NOTICE** Damage to the device due to excessive input voltage! Check whether the voltage specifications on the AC adapter match those of the power supply at the installation site.
 - ▶ If the input voltage is too high: Do **not** connect the device to the power supply.
 - ▶ Contact Sartorius Service.
- ▶ Connect the mains plug of the power supply cable to the wall outlet at the installation site.
- ▷ The [BOOTING] display appears in the operating display.
- ▷ The device performs a self-test.
- ▷ The device performs an initial tare function.

7 System Settings

7.1 Performing System Settings

Default settings can be adjusted for the device and the applications in order to align with the ambient conditions and individual operating requirements.

The following settings are necessary to operate the device together with connected components:

- Set up the communication of the connected devices
- Set up additional components

The following settings are recommended to set up the device:

- Set the menu language
- Set the behavior of the isoCAL function
- Set the behavior of the motorized draft shield (only for devices with a motorized draft shield)

Procedure

- ▶ Press the [Menu] button.
- ▶ Open the desired settings menu.
- ▶ To adjust settings: Open the desired main menu and submenu.
- ▶ Select and confirm the desired configuration value (configuration values, see Chapter "7.3 Parameter List", page 29).
- ▶ Exit the menu.
- ▷ If settings have been adjusted in the "SETUP", "DEVICE", "DATA.OUTPUT" or "APPLIC." menu: The [BOOTING] display appears in the operating display and the device restarts.

7.2 Switching Off the isoCAL Function

M

If the isoCAL function is switched off for a conformity-assessed device, the device can only be used for legal-for-trade applications in restricted temperature ranges (see Chapter "15.6.2 Ambient Temperature for the isoCAL Function", page 58). The isoCAL function cannot be switched off for all model versions.

Procedure

- ▶ In the "SETUP"/"BALANCE" menu, for the "ISOCAL" parameter, select the "OFF" configuration value.

7.3 Parameter List

7.3.1 Parameters in the "Setup" Main Menu

Parameters in the "Balance" Submenu

Parameters	Setting values	Explanation
AMBIENT	V.STABLE	Sets the ambient conditions to "very stable": Activates a fast change in the weight values in the event of a load change with a high output rate. Recommended for the following work environment: <ul style="list-style-type: none"> – Very stable table near the wall – Closed and calm room
	STABLE*	Sets the ambient conditions to "stable". Recommended for the following work environment: <ul style="list-style-type: none"> – Stable table – Slight movement in the room – Slight draft
	UNSTABL.	Sets the ambient conditions to "unstable": Activates the delayed change in weight values with a reduced output rate. Recommended for the following work environment: <ul style="list-style-type: none"> – Simple office desk – Room with moving machinery or personnel – Slight air movement
	V.UNSTBL.	Sets the ambient conditions to "very unstable": Activates a significantly delayed change in the weight values and long wait for stability with a further reduction in the output rate. Recommended for the following work environment: <ul style="list-style-type: none"> – Noticeable and slow floor vibrations – Noticeable building vibrations – Weighed goods moved – Very strong air movements
APP FILT.	FINAL.RD.*	Activates a filter that enables a fast change in the display for very fast load changes. Display changes with minimal load changes (in the digit range) occur more slowly.
	FILLING	Activates a filter that enables a very fast change in the display with minimal load changes (e.g. when filling containers).
	REDUC.	Activates a weak but fast filter that always behaves in the same way for load changes (e.g. when filling automated systems).
	OFF	Deactivates the active application filter.
STABIL.	MAX ACC.	Sets the stability to "maximum accuracy".
	V. ACC.	Sets the stability to "very accurate".
	ACC.*	Sets the stability to "accurate".
	FAST	Sets the stability to "fast".
	V. FAST	Sets the stability to "very fast".
	MAX.SPEED	Sets the stability to "maximum speed".

* Factory setting

Parameters	Setting values	Explanation
ST.DEL.	NONE	Sets the stability delay to "none": The stability symbol is displayed after the stability criterion is reached.
	SHORT*	Sets the stability delay to "short": The stability symbol only appears after a short delay in order to provide a reliable result despite fluctuations.
	MEDIUM	Sets the stability delay to "medium": The stability symbol only appears after a longer delay in order to provide a reliable result in case of higher fluctuations.
	LONG	Sets the stability delay to "long": The stability symbol only appears after a long delay in order to balance out major instability.
ZERO/TAR.	W/O STB.	Without stability: The function of the [Zero] or [Tare] key is executed immediately once the key is pressed.
	W/ STAB.*	With stability: The function of the [Zero] or [Tare] key is only executed after stability is achieved.
	AT STAB.	At stability: The function of the [Zero] or [Tare] key is executed if stability exists when the key is pressed.
AUTOZER.	ON*	Activates automatic zeroing. The display is automatically set to zero in case of a deviation of 0 less than (X).
	OFF	Deactivates automatic zeroing. Zeroing must be triggered with the [Zero] key.
UNIT		The availability of units may depend on national legislation and is therefore country-specific.
	GRAMS*	The device displays the weight in grams.
	KILOGR.	The device displays the weight in kilograms (not for semi-microbalances).
	CARATS	The device displays the weight in carats.
	POUNDS	The device displays the weight in pounds (not for semi-microbalances).
	OUNCES	The device displays the weight in ounces.
	TROY OZ.	The device displays the weight in troy ounces.
	HKTAEL	The device displays the weight in taels (Hong Kong).
	SNGTAE	The device displays the weight in taels (Singapore).
	TWNTAE	The device displays the weight in taels (Taiwan).
	GRAINS	The device displays the weight in grains.
	PENYWT.	The device displays the weight in pennyweights.
	MILLIGR.	The device displays the weight in milligrams.
	CHINATAEL	The device displays the weight in taels (China).
	MOMMES	The device displays the weight in mommes.
	TOLA	The device displays the weight in tolas.
	BAHT	The device displays the weight in baht.
MESGHAL	The device displays the weight in mesghals.	
NEWTON	The device displays the weight in newtons.	
DISP.DIG.	ALL*	"Show all decimal places": All decimal places are shown in the display. Not available on conformity-assessed devices.
	LP.ON/OFF	"Reduced by 1 decimal place for load change": The last decimal place on the display is switched off until stability is achieved.
	DIVIS. 1	"Last decimal place of the 1st division": The last decimal place always shows the 1st division.
	MINUS 1	"Last decimal place off": The last decimal place is switched off.

* Factory setting

Parameters	Setting values	Explanation
CAL./ADJ.	EXT.CAL.	The [Adjust] button starts an external calibration with the preset calibration weight.
	E.CAL.USR.	The [Adjust] button starts an external calibration with the user-defined calibration weight value.
	INT.CAL.*	The [Adjust] button starts an internal calibration.
CAL.SEQ.	ADJUST*	Calibration and adjustment is one routine.
	CAL.-ADJ.	Adjustment must be started or exited manually after calibration with the [Adjust] button.
ON Z/T	ON*	Activates the initial taring/zeroing. The device is tared or zeroed after it is switched on.
	OFF	Deactivates the initial taring/zeroing: After it is switched on, the device shows the value before it was last switched off.
ISOCAL	OFF	Switches the isoCAL function off.
	NOTE TO	The [isoCAL] button flashes if the balance needs to be adjusted. The isoCAL function must be manually triggered with the [Adjust] button.
	ON*	Activates the isoCAL function. The device is automatically adjusted as soon as a trigger starts the isoCAL function.
CAL.UNIT	GRAMS*	Changes the calibration weight unit to grams.
	KILOGR.	Changes the calibration weight unit to kilograms.

* Factory setting

Parameters in the "General Services" Submenu

Parameters	Setting values	Explanation
MEN.RESET	YES	Resets the system settings to the factory default settings.
	NO*	Deactivates the option of resetting the device menu.

* Factory setting

7.3.2 Parameters in the "Device" Main Menu

Parameters in the "Extras" Submenu

Parameters	Setting values	Explanation
MENU	EDITABLE*	Activates write access: The menu parameters can be changed.
	RD.ONLY	Activates read access: The menu parameters cannot be changed.
SIGNAL	OFF	Switches the acoustic signal off.
	QUIET	Sets the volume of the acoustic signal to "quiet".
	MEDIUM*	Sets the volume of the acoustic signal to "medium".
	LOUD	Sets the volume of the acoustic signal to "loud".
KEYS	UNLOCKED*	Deactivates the key lock.
	LOCKED	Activates the key lock.
ON MODE	ON/STDBY*	The [On/Off] key switches between on/standby.
	ON/OFF	The [On/Off] key switches between on/off.
	AUTO ON	Changes the function of the [On/Off] key: The device no longer switches off or to standby mode, instead it starts a boot process.
LIGHTING	OFF	Deactivates the lighting on the operating display.
	ON*	Activates the lighting on the operating display.

* Factory setting

Parameters in the "Leveling" Submenu

Parameters	Setting values	Explanation
LEVEL	OFF	The device does not display messages on the status of the level.
	NOTE*	The [LEVELING] display flashes if the device needs to be leveled.
	ERR.MSG.	The [LEVEL.ERR.] message appears in the operating display if the device has not been leveled.
START	KEY	Sets the trigger for leveling to "key": Leveling must be started manually by pressing the [Leveling] button.
	AUTO*	Sets the trigger for leveling to "automatic": The device automatically performs a leveling function using the integrated sensor before every internal calibration/adjustment.

* Factory setting

Parameters in the "Sensor" Submenu

Parameters	Setting values	Explanation
CONTROL	OFF	Deactivates the motion sensor: No gestures are recognized.
	ON*	Activates the motion sensor.
NUM.GEST.	2 GESTUR.*	Activates the control of functions with 2 gestures. Gestures: Left, right
	4 GESTUR.	Activates the control of functions with 4 gestures. Gestures: Left, right, top, bottom
LEFT.CMD.	PRINT*	Left command of the gesture control corresponds to the [Print] key.
	ZERO	Left command of the gesture control corresponds to the [Zero] key.
	TARE	Left command of the gesture control corresponds to the [Tare] key.
	NONE	No function is assigned to the left command of the gesture control.
RIGHT.CMD.	PRINT*	Right command of the gesture control corresponds to the [Print] key.
	ZERO	Right command of the gesture control corresponds to the [Zero] key.
	TARE	Right command of the gesture control corresponds to the [Tare] key.
	NONE	No function is assigned to the right command of the gesture control.
UP.CMD.	PRINT*	Upper command of the gesture control corresponds to the [Print] key.
	ZERO	Upper command of the gesture control corresponds to the [Zero] key.
	TARE	Upper command of the gesture control corresponds to the [Tare] key.
	NONE	No function is assigned to the upper command of the gesture control.
DOWN.CMD.	PRINT*	Lower command of the gesture control corresponds to the [Print] key.
	ZERO	Lower command of the gesture control corresponds to the [Zero] key.
	TARE	Lower command of the gesture control corresponds to the [Tare] key.
	NONE	No function is assigned to the lower command of the gesture control.

* Factory setting

Parameters in the "COM-RS232" Submenu

Parameters	Setting values	Explanations
DAT.REC.	SBI.WEIGH.	Enables a faster SBI communication, only for software commands to the weighing module.
	XBPI	Extended range of commands to control numerous balance functions with binary protocol for direct communication with the weighing module.
	SBI*	Enables SBI communication. The data is output to a PC or control unit. Enables the use of ESC commands from a PC to control the basic balance functions with ASCII protocol.
	OFF	Deactivates the automatic data output.

* Factory setting

Parameters	Setting values	Explanations
BAUD	600	Sets the baud rate to 600 baud.
	1200	Sets the baud rate to 1200 baud.
	2400	Sets the baud rate to 2400 baud.
	4800	Sets the baud rate to 4800 baud.
	9600*	Sets the baud rate to 9600 baud.
	19200	Sets the baud rate to 19200 baud.
	38400	Sets the baud rate to 38400 baud.
	57600	Sets the baud rate to 57600 baud.
PARITY	115200	Sets the baud rate to 115200 baud.
	ODD*	Applies an odd parity.
	EVEN	Applies an even parity.
STOPBIT	NONE	Does not apply a parity.
	1 BIT*	Sets the number of stop bits to 1.
HANDSHK.	2 BITS	Sets the number of stop bits to 2.
	SOFTWARE	Sets the handshake protocol to software handshake.
DATABIT	HARDWARE*	Sets the handshake protocol to hardware handshake.
	NONE	Does not set a handshake protocol.
DATABIT	7 BITS	Sets the number of data bits to 7.
	8 BITS*	Sets the number of data bits to 8.

* Factory setting

Parameters in the "PC-USB" Submenu

Parameters	Setting values	Explanations
DAT.REC.	SBI.WEIGH.	Enables a faster SBI communication, only for software commands to the weighing module.
	XBPI	Extended range of commands to control numerous balance functions with binary protocol for direct communication with the weighing module.
	SBI*	Enables SBI communication. The data is output to a PC or control unit. Enables the use of ESC commands from a PC to control the basic balance functions with ASCII protocol.
	PC.SPREAD.	Enables data output to a spreadsheet program via a direct PC connection.
	PC.TEXT	Enables a direct PC connection to be established to a text processing program.
	OFF	Deactivates the data output.
BAUD	600	Sets the baud rate to 600 baud.
	1200	Sets the baud rate to 1200 baud.
	2400	Sets the baud rate to 2400 baud.
	4800	Sets the baud rate to 4800 baud.
	9600*	Sets the baud rate to 9600 baud.
	19200	Sets the baud rate to 19200 baud.
	38400	Sets the baud rate to 38400 baud.
	57600	Sets the baud rate to 57600 baud.
PARITY	115200	Sets the baud rate to 115200 baud.
	ODD*	Applies an odd parity.
	EVEN	Applies an even parity.
	NONE	Does not apply a parity.

* Factory setting

Parameters	Setting values	Explanations
STOPBIT	1 BIT*	Sets the number of stop bits to 1.
	2 BITS	Sets the number of stop bits to 2.
HANDSHK.	SOFTWARE	Sets the handshake protocol to software handshake.
	HARDWARE	Sets the handshake protocol to hardware handshake.
	NONE*	Does not set a handshake protocol.
DATABIT	7 BITS	Sets the number of data bits to 7.
	8 BITS*	Sets the number of data bits to 8.

* Factory setting

Parameters in the "USB" Submenu

Parameters	Setting values	Explanation
DEV.USED	NONE*	Indicates that no device connection is detected at the USB port.
	[Device Designation]	Displays the designation of the devices connected to the USB port.

* Factory setting

7.3.3 Parameters in the "Data Output" Main Menu

Parameters in the "SBI Communication" Submenu

Parameters	Setting values	Explanations
COM. OUTP.	IND.NO*	Starts the data output after pressing the key or software command as an individual value without stability.
	IND.AFTER	Starts the data output after pressing the key or software command as an individual value without stability.
	IND.AT	Starts the data output after pressing the key or software command as an individual value at stability.
	AUTO W/O	Activates the automatic data output without stability.
	AUTO W/	Activates the automatic data output after stability.
STOP.AUTO	OFF*	Deactivates the option to abort the automatic data output.
	ON	The automatic data output is aborted by pressing the [PRINT] key or a software command.
AUTO.CYCL.	EACH VAL*	Starts the automatic data output with a cycle after each value.
	2. VALUE	Starts the automatic data output with a cycle after every 2nd value.
FORMAT	16 CHARS	16 characters per line are data output.
	22 CHARS*	Data output provides 22 characters per line (16 characters for the measured values and 6 characters for identifiers).
	EXTR.LINE	Data output provides an additional line with the date, time, and weight value.
AUTO.TARE	OFF*	Deactivates automatic taring after data output.
	ON	The device automatically tares after data output.

* Factory setting

Parameters in the "Settings for Printouts" Submenu

Parameters	Setting values	Explanation
ACTIVATE	MAN. NO	Manual without stability: Print process can be started manually at any time.
	MAN.AFTER*	Manual after stability: After pressing the [Print] key, the print command is only executed once stability is achieved.
	MAN.AT	Manual at stability: Print process can be started manually when stability is achieved.
	AUTO.LC	Automatically at load change: Print process starts after every load change.
FORMAT	22 CHARS*	Printer output prints 22 characters per line (16 characters for the measured values and 6 characters for identifiers)
	EXTR.LINE	Printer output prints an additional line with the date, time, and weight value.
PRINT.INIT	OFF	Deactivates the output of the application parameters.
	ALL*	Print command prints all parameters.
	MAIN PAR.	Print command only prints the main parameters.
GLP	OFF*	Deactivates the GLP printout.
	CAL.-ADJ.	Activates the GLP printout for all calibration and adjustment processes.
	ALWAYS	The GLP printout is always switched on. All printouts contain a GLP header and a GLP footer.
TAR./PRT.	OFF*	Deactivates automatic taring after printer output.
	ON	Automatically tares the device after every printout.
TIME	24H	Sets the time to 24-hour mode.
	12H	Sets the time to 12-hour mode (AM/PM).
DATE	DD.MMM.YY*	Sets the date display format to DD.MMM.YY
	MMM.DD.YY	Sets the date display format to MMM.DD.YY

* Factory setting

Parameters in the "PC Direct Transfer" Submenu

Parameters	Setting values	Explanations
DEC.SEPAR.	DEC.POINT*	Sets a point as a decimal separator.
	DEC.COMMA	Sets a comma as a decimal separator.
OUTP.FORM.	TEXT+NUM.*	Exports text and numbers.
	ONLY NUM.	Only exports numbers.

* Factory setting

7.3.4 Parameters in the "Applications" Main Menu**Parameters in the "Weighing" Submenu**

Parameters	Setting values	Explanation
UNIT	ON*	Activates the "Toggle between weight units" function.
	OFF	Deactivates the "Toggle between weight units" function.

* Factory setting

Parameters in the "Counting" Submenu

Parameters	Setting values	Explanation
RESOLUT.	DISP.ACC.*	Sets the resolution to "display resolution". The "Counting" application is started with the displayed value.
	10-FOLD	Sets the resolution to 10-times more accurate than "display resolution".
	100-FOLD	Sets the resolution to 100-times more accurate than "display resolution".
REF.UPDT.	OFF*	Deactivates automatic reference sample updating.
	AUTO	Activates the automatic reference sample updating.

* Factory setting

Parameters in the "Weighing in Percent" Submenu

Parameters	Setting values	Explanation
DEC.PLCS	NONE	The result of the "Weighing in Percent" application is displayed without decimal places.
	1 DEC.PL.*	The result of the "Weighing in Percent" application is displayed to 1 decimal place.
	2 DEC.PL.	The result of the "Weighing in Percent" application is displayed to 2 decimal places.
	3 DEC.PL.	The result of the "Weighing in Percent" application is displayed to 3 decimal places.

* Factory setting

Parameters in the "Net-Total" Submenu

Parameters	Setting values	Explanation
COMP.PRT.	OFF	Deactivates the component printout.
	ON*	Activates the component printout.

* Factory setting

Parameters in the "Totalizing" Submenu

Parameters	Setting values	Explanation
COMP.PRT.	OFF	Deactivates the component printout.
	ON*	Activates the component printout.

* Factory setting

Parameters in the "Animal Weighing" Submenu

Parameters	Setting values	Explanation
ACTIVITY	CALM	Sets the intensity of the "Animal activity" to "calm". Recommended for minor movements of the sample, e.g. caused by placement on the weighing pan.
	MEDIUM*	Sets the intensity of the "Animal activity" to "medium". Recommended for medium movements of the sample, e.g. caused by placement on the weighing pan.
	V.ACTIVE	Sets the intensity of the "Animal activity" to "very active". Recommended for very active movements of the sample, e.g. caused by placement on the weighing pan.
START	MANUAL	The "Animal weighing" application must be manually selected in the start screen.
	AUTO*	Sets the trigger to start the "Animal weighing" application to "automatic".

* Factory setting

Parameters in the "Calculation" Submenu

Parameters	Setting values	Explanation
METHOD	MUL.*	Specifies multiplication as the method of calculation for the "Calculation" application.
	DIV.	Specifies division as the method of calculation for the "Calculation" application.
DEC.PLCS	NONE	The result of the "Calculation" application is displayed without decimal places.
	1 DEC.PL.*	The result of the "Calculation" application is displayed to 1 decimal place.
	2 DEC.PL.	The result of the "Calculation" application is displayed to 2 decimal places.
	3 DEC.PL.	The result of the "Calculation" application is displayed to 3 decimal places.

* Factory setting

Parameters in the "Density Determination" Submenu

Parameters	Setting values	Explanation
DEC.PLCS	NONE	The result of the "Density determination" application is displayed without decimal places.
	1 DEC.PL.*	The result of the "Density determination" application is displayed to 1 decimal place.
	2 DEC.PL.	The result of the "Density determination" application is displayed to 2 decimal places.
	3 DEC.PL.	The result of the "Density determination" application is displayed to 3 decimal places.

* Factory setting

Parameters in the "Statistics" Submenu

Parameters	Setting values	Explanation
COMP.PRT.	OFF	Deactivates the component printout.
	ON*	Activates the component printout.
TAR./STAT.	OFF*	Deactivates automatic taring after the components are saved.
	ON	Activates automatic taring after the components are saved.

* Factory setting

7.3.5 Parameters in the "Input" Main Menu

Parameters	Setting values	Explanation
ID NO.	Maximum of 8 characters 09-0, A-Z, -, space	Saves the entered ID number for the device.
LOT ID	OFF*	Deactivates the prompt of lot ID number during data output.
	ON	Activates the prompt of the lot ID number during data output.
DATE		Saves the entered date.
TIME		Saves the entered time.
USER.PASS.	Maximum of 8 characters 09-0, A-Z, -, space	Saves the entered user password.
DEL.PASS.	YES	Deletes the entered user password.
	NO*	Does not delete the entered user password.
SERV.PASS.	Max 8 characters 09-0, A-Z, -, empty	Activates service mode.
CAL.WT.		Changes the calibration weight for the adjustment or calibration process with the user-defined weight value.
* Factory setting		

7.3.6 Parameters in the "Language" Main Menu

Parameters	Setting values	Explanation
Language	ENGLISH*	English
	DEUTSCH	German
	FRANCAIS	French
	ITALIANO	Italian
	ESPANOL	Spanish
	PORTUG.	Portuguese
	PYCKKИИ	Russian
	POLSKI	Polish
* Factory setting		

7.3.7 Parameters in the "Unit 1", "Unit 2", "Unit 3", and "Unit 4" Function Menus

Parameters	Setting values	Explanation
NONE*		The availability of units may depend on national legislation and is therefore country-specific.
		Switches the toggle between weight units off for this position.
GRAMS – Newton	NONE*	The configuration values for the [DISP.DIG.] parameter in the [BALANCE] menu are saved for the scale interval ([DISP.DIG.] parameter see 7.3, 29).
	ALL	"Show all decimal places": All decimal places are shown in the display.
	LP.ON/OFF	"Reduced by 1 decimal place for load change": The last decimal place on the display is switched off until stability is achieved.
	DIVIS. 1	"Last decimal place of the 1st division": The last decimal place always shows the 1st division.
	MINUS 1	"Last decimal place off": The last decimal place is switched off and the measured value is rounded up or down by one decimal place.
* Factory setting		

8 Operation

8.1 Switching the Device On and Off

The device only delivers accurate values if it has reached the necessary operating temperature. The warm-up time after switching the device on must therefore be complied with.

Procedure

- ▶ Connect the device to the power supply.
 - ▶ If the device does not switch on automatically after it is connected to the power supply: Press the on key on the weighing module.
 - ▶ To allow the device to reach the necessary operating temperature to accurately determine the weight: Comply with the warm-up time of 2 hours after switching the device on.
- M**
- ▷ If this relates to a conformity-assessed device: The weight value is marked as invalid during the warm-up period.
 - ▶ Level and adjust the device.
 - ▷ The device is ready for use.
 - ▶ **NOTICE** Pointed or sharp-edged objects may damage the operating display! Touching the operating display with objects, such as pens, may damage the touchscreen surface of the operating display. Only touch the operating display with your fingertips.
 - ▶ To switch the device off: Press and hold the [On / Off] key.

8.2 Leveling the Device

8.2.1 Leveling the Device with the Level

Leveling compensates any inclines at the device's installation site. Minor inclines can be compensated with the front leveling feet. If leveling is necessary: The level's air bubble is not located within the circle marking.

Procedure

- ▶ Retract both rear leveling feet.
- ▶ Turn the front leveling feet (2) until the level's air bubble is located in the center of the circle marked on the level (1).

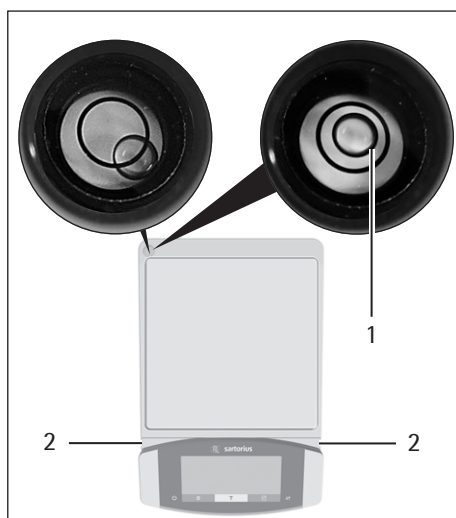

- ▶ For models with rear leveling feet: Screw out both rear leveling feet until they touch the setup surface.

8.2.2 Leveling a Device with Manual Feet with Inclination Sensor

The inclination sensor detects inclines in the alignment of the device. If leveling is necessary: The "Leveling" display flashes.

Procedure

- ▶ Press the "Leveling" button.
- ▷ The leveling process starts.
- ▷ The "RETRACT" display appears.
- ▶ Retract both rear leveling feet.
- ▶ Press the "Confirm" button on the keypad.
- ▷ The "Directional arrows" display and the "TURN" display appear in the operating display for every leveling foot.
- ▶ Turn the front leveling feet in the direction indicated by the "Directional arrows" display until the "Directional arrows" display disappears for both leveling feet.
- ▷ The "EXTEND" display appears.
- ▶ Screw out both rear leveling feet until they touch the setup surface.
- ▷ Press the "Confirm" button on the keypad.



8.3 Preparing Weighings

The device must be prepared before every weighing.

Requirements

The device is ready for use

NOTICE

Chemicals may damage the device or accessories!

Chemicals can attack the device or the connected accessories internally and externally. This may damage the device and accessories.

- ▶ Use appropriate containers when weighing chemicals.

Procedure

- ▶ Level the device.
- ▶ Zero the device for calibration. To do so, press the [Zero] key.
- ▶ If the device **cannot** be zeroed: Remove the sample to be weighed and re-zero the device.
- ▶ Calibrate the device.

8.4 Weighing

Procedure

- ▶ Zero the device.
- ▶ If necessary, place a container for the sample on the device.
- ▶ To compensate the weight of the container: Tare the device. To do so, press the [Tare] key.
- ▶ If a container is used for the sample: Place the sample in the container.
- ▶ If **no** container is used for the sample: Place the sample on the weighing pan.
- ▶ Once the weight value no longer changes and the weighing unit is displayed: Read off the measured value.

8.5 Overview of Calibration, and Adjustment

During calibration, a calibration weight is used to determine how much the displayed value deviates from the actual value. This deviation is compared against a preset target value. The subsequent adjustment eliminates this deviation.

Calibration and adjustment must be performed regularly:

- Daily, every time the device is switched on
- After every leveling
- After changing the ambient conditions (temperature, humidity, or air pressure)
- After setting the device up at a new installation site

Calibration and adjustment may be performed in different ways:

- Adjusting with the isoCAL function
- Internal or external calibration or adjustment

M

Only internal calibration / adjustment is possible for all conformity-assessed devices in legal metrology.

8.6 Adjusting with the isoCAL Function

The device can be automatically internally calibrated and adjusted using the isoCAL function.

Requirements

- The device is **not** located in the menu.
- Alphanumeric inputs are **not** active.
- The load on the weighing pan remains unchanged for 2 minutes.
- The load on the weighing pan amounts to no more than 2% of the maximum load.
- The device does **not** register an input for 2 minutes.

If all requirements for starting the isoCAL function are met and one of the following conditions occurs: The isoCAL function is automatically triggered.

Possible conditions are:

- The ambient temperature has changed since the last adjustment/calibration.
- The interval time was exceeded (interval time, see Chapter "15.8 Recommended Calibration Weight", page 62).
- The device has been leveled.
- The device has been disconnected from the power supply since the last adjustment/calibration (only for conformity-assessed models).

Procedure

- ▶ If the isoCAL auto-start function is set (configuration values for the "ISOCAL" parameter, see Chapter "7.3.1 Parameters in the "Setup" Main Menu", page 29):
 - ▷ If the isoCAL function is triggered according to the aforementioned conditions: The [isoCAL] button flashes in the operating display.
 - ▷ In the operating display, a time display counts down from 15 seconds to 0.
 - ▷ If **no** load change or **no** operation takes place on the device before the expiration of the time display: The isoCAL function starts.
- ▶ If the isoCAL manual start function is set (configuration values for the "ISOCAL" parameter, see Chapter "7.3.1 Parameters in the "Setup" Main Menu", page 29):
 - ▷ If the isoCAL function is triggered: The [isoCAL] button flashes in the operating display.
 - ▶ Press the [isoCAL] button.
 - ▷ The isoCAL function starts.

8.7 Internally Calibrating and Adjusting the Device

Calibration and Subsequent Adjustment

Requirements

- The weighing pan is unloaded.
- The operating display shows a stable weight value.

Procedure

- ▶ To set the internal adjustment in the menu: In the "SETUP"/"BALANCE" menu, for the "CAL./ADJ." parameter, select the "INT.CAL." configuration value.
- ▶ To set the sequence of the adjustment function to calibration and subsequent automatic adjustment: In the "SETUP"/"BALANCE" menu, for the "CAL.SEQ." parameter, select the "ADJUST" configuration value.
- ▶ Exit the menu.
- ▶ Press the [Zero] key.
- ▶ To start the internal calibration/adjustment: Press the [Adjust] button.
- ▶ If automatic leveling is set for a model with motorized adjusting feet: The device levels itself automatically.
 - ▷ The internal calibration weight is loaded.
 - ▷ The [CAL.RUN.] display appears in the operating display during calibration.
 - ▷ The device is automatically calibrated and the internal calibration weight is removed.
 - ▷ The [CAL.END] display indicates the end of calibration.

Manually Starting Adjustment after Calibration

Requirements

- The weighing pan is unloaded.
- The operating display shows a stable weight value.

Procedure

- ▶ To set the internal adjustment in the menu: In the "SETUP"/"BALANCE" menu, for the "CAL./ADJ." parameter, select the "INT.CAL." configuration value.
- ▶ To set the sequence of the adjustment function to calibration without subsequent automatic adjustment: In the "SETUP"/"BALANCE" menu, for the "CAL.SEQ." parameter, select the "CAL/ADJUST" configuration value.
- ▶ Exit the menu.
- ▶ Press the [Zero] key.
- ▶ To start the internal calibration: Press the [Adjust] button.
- ▷ The internal calibration weight is loaded.
- ▷ The [CAL.RUN.] display appears in the operating display during calibration.
- ▷ The calibration weight value is shown.
- ▶ To start adjustment: Press the [Confirm] button on the keypad.
- ▷ The device is calibrated and the internal calibration weight is removed.
- ▷ The [CAL.END] display indicates the end of calibration.

8.8 Externally Calibrating and Adjusting the Device (Not for Conformity-assessed Models)

External Calibration with Factory Set Weight Value

Procedure

- ▶ In the "SETUP"/"BALANCE" menu, for the "CAL./ADJ." parameter, select the "EXT.CAL." configuration value.

Set the User-defined Weight Value

A weight value can be set for the calibration weight. This user-defined weight value is used for the external calibration.

If no user-defined weight value is set: The preset weight value is used.

Procedure

- ▶ In the "INPUT" menu, select the "CAL.WT." configuration value.
- ▶ Enter and confirm the desired weight value.
- ▶ To use the user-defined weight value for the next calibration: In the "Balance" menu, for the "CAL./ADJ." parameter, select the "E.CAL.USR." configuration value.

Calibration and Subsequent Adjustment

Requirements

- The weighing pan is unloaded.
- The operating display shows a stable weight value.
- The device is not locked against external calibration.
- Keep calibration weight ready for use.

Procedure

- ▶ To set the external calibration in the menu: In the "SETUP"/"BALANCE" menu, for the "CAL./ADJ." parameter, select external calibration with preset calibration weight or external calibration with user-defined calibration weight as described above.
- ▶ To set the sequence of the adjustment function to calibration and subsequent automatic adjustment: In the "SETUP"/"BALANCE" menu, for the "CAL.SEQ." parameter, select the "ADJUST" configuration value.
- ▶ Exit the menu.
- ▶ Press the [Zero] key.
- ▶ Press the [Adjust] button.
- ▶ Place the indicated calibration weight on the balance. The device is automatically adjusted after calibration, if the calibration weight placed on the device is within the specified limits.
 - ▷ The [+] sign is shown if the applied weight is too high.
 - ▷ The [-] sign is shown if the applied weight is too low.
- ▷ The [CAL.END] message indicates the end of calibration.
- ▶ Remove the calibration weight after calibration is complete.

Manually Starting Adjustment after Calibration

Requirements

- The weighing pan is unloaded.
- The operating display shows a stable weight value.
- The device is not locked against external calibration.

Procedure

- ▶ To set the external calibration in the menu: In the "SETUP"/"BALANCE" menu, for the "CAL./ADJ." parameter, select external calibration with preset calibration weight or external calibration with user-defined calibration weight as described above.
- ▶ To set the sequence of the adjustment function to calibration without subsequent automatic adjustment: In the "SETUP"/"BALANCE" menu, for the "CAL.SEQ." parameter, select the "CAL/ADJUST" configuration value.
- ▶ Exit the menu.
- ▶ Press the [Zero] key.
- ▶ Press the [Adjust] button.
- ▶ Place the indicated calibration weight on the balance. The calibration can only be started, if the calibration weight used is within the defined limits.
 - ▷ The [+] sign is shown if the applied weight is too high.
 - ▷ The [-] sign is shown if the applied weight is too low.
- ▶ Press the [Confirm] button on the keypad. This starts the calibration.
- ▷ The [CAL.END] display indicates the end of calibration.
- ▶ Remove the calibration weight after calibration is complete.

8.9 Printing Results

The results of the calibration can be printed in a GLP printout.

Procedure

- ▶ Set the GLP printout in the menu (setting parameters, see Chapter "Parameters in the "Settings for Printouts" Submenu", page 35):
- ▶ Calibrate the device.
- ▷ Once the calibration is complete:
 - ▷ The printing process starts.
 - ▷ The GLP footer is printed.

8.10 Weighing and Printing with ID Marking

The device and every lot can be assigned an ID number. The ID numbers are provided in the GLP header during GLP-compliant printing.

Requirements

- The ID marking is entered in the menu, e.g. "BATCH1" (see Chapter "7.3.5 Parameters in the "Input" Main Menu", page 38).
- The printing of the lot ID line in the GLP printout is activated in the menu (see Chapter "7.3.5 Parameters in the "Input" Main Menu", page 38).
- The GLP-compliant printout is activated (see Chapter "7.3.5 Parameters in the "Input" Main Menu", page 38).
- The format for the printout is set to 22 characters per line (configuration parameters, see Chapter "7.3.3 Parameters in the "Data Output" Main Menu", page 34).

Procedure

- ▶ Start the printout. To do so, press the [Print] key.
- ▶ The GLP header is printed with the ID marking set in the menu and the current weight value.
- ▶ The [GLP] button appears in the operating display.
- ▶ To exit the GLP printout: Press the [GLP] button.
- ▷ The GLP footer is printed.

```

-----
23-Apr-2018    13:06
      Sartorius
Mod.          MCE6202S
Ser. no.      12345678
Ver. 09-05-00.09.01
ID           CHARGE01
-----
L ID
G           +    50.12 g
-----
23-Apr-2018    13:07

```

8.11 Running Applications (Examples)

8.11.1 Executing the "Toggle Between Weight Units" Function

The "Toggle between weight units" function enables a switch between the basic unit display and up to 4 other units. The units can be set during the weighing process and the decimal places can be adjusted.

The basic unit is displayed every time the device is started.

Procedure

- ▶ To activate the "Toggle between weight units" function in the menu: In the "BALANCE" menu, for the "UNIT" parameter, select the "ON" configuration value.
- ▶ Exit the settings menu.
- ▷ The device boots up.
- ▶ To select the convertible units: Press and hold down the "Toggle between weight units" button of the "Change" key.
- ▶ The "Toggle between weight units" function menu opens.
- ▶ Select a submenu from "Unit 1" – "Unit 4".
- ▶ Select the desired unit and confirm the display (available units, see Chapter "7.3.7 Parameters in the "Unit 1", "Unit 2", "Unit 3", and "Unit 4" Function Menus", page 38).
- ▶ To set the number of display digits for the selected unit: Press the "Confirm" button (configuration parameters, see Chapter "7.3.7 Parameters in the "Unit 1", "Unit 2", "Unit 3", and "Unit 4" Function Menus", page 38).
- ▶ Select the desired number of display digits and confirm the selection.
- ▶ Exit the "Toggle between weight units" function menu.
- ▷ The current weight value is displayed in the selected unit.
- ▶ To switch the displayed mass unit during weighing or before starting an application: Press the "Toggle between weight units" button or the "Change" key multiple times if necessary, until the desired unit is displayed.
- ▷ The current weight value is displayed in the selected unit.

8.11.2 Running the "Statistics" Application

The "Statistics" application saves up to 99 weight values and evaluates these statistically.

The following values are saved and exported by the statistics application:

- Number of components
- Mean value
- Standard deviation
- Variation coefficient
- Sum of all values
- Lowest value (minimum)
- Highest value (maximum)
- Spread: Difference between maximum and minimum

The "Statistics" application can be combined with the following functions:

- Toggle between weight units only available before starting the application
- ID marking
- Automatic taring

```

-----
Comp01+      100.22 g

```

```

Comp02+      100.21 g

```

```

-----
n              6
x   +      100.258 g
s   +       0.037 g
sRel +       0.04 %
Sum +       601.55 g
Min +       100.21 g
Max +       100.31 g
Diff +        0.10 g
-----

```

Procedure

- ▶ Select the Statistics application in the "APPLIC." menu.
 - ▶ Exit the settings menu.
 - ▶ Place a sample on the weighing pan.
 - ▶ Change the displayed weight unit if necessary.
 - ▶ To start the recording of the statistics: Press the [Confirm] button on the keypad.
 - ▶ The current weight value is saved.
-
- ▶ To save the next value:
 - ▶ Remove the sample on the weighing pan.
 - ▶ Place a new sample on the weighing pan and press the [Confirm] button.
 - ▶ To switch between the display of the current weight value, the number of saved components, and the calculated mean in the results display: Press the [Up] or [Down] button.
 - ▶ To print and exit the current statistics, and to delete the saved values: Press the [Back] or [GLP] button.

9 Cleaning and Maintenance

9.1 Preparing the Device

Procedure

- ▶ Turn the device off.
- ▶ Disconnect the device from the power supply.
- ▶ Remove the weighing pan and all associated components from the weighing module, e.g. shield plate, pan support.

9.2 Cleaning the Device

NOTICE

Corrosion or damage to the device due to unsuitable cleaning agents!

- ▶ Do **not** use corrosive, chloride-containing, or aggressive cleaning agents.
 - ▶ Do **not** use cleaning agents that contain abrasive ingredients, e.g. scouring agents, steel wool.
 - ▶ Do **not** use solvent-based cleaning agents.
 - ▶ Check whether the cleaning agents used are compliant materials (see Chapter "15.3 Materials", page 57).
 - ▶ Make sure that cleaning materials, such as cloths, are only slightly damp.
-

Procedure

- ▶ **NOTICE** Malfunction or damage to the device due to the ingress of moisture or dust!
 - ▶ Remove dust and powdery sample residue with a brush or hand-held vacuum cleaner.
- ▶ **NOTICE** Corrosion or damage to the weighing pan due to unsuitable cleaning agents
 - ▶ Wipe down the weighing pan and the shield plate with a cleaning agent and a cloth. The cleaning agent must be suitable for stainless steel and titanium.
- ▶ Wipe the associated components of the weighing pan with a brush or a damp cleaning cloth, e.g. shield plate, support pan.
- ▶ Wipe the device housing with a damp cloth. For more severe contamination, use a mild soap solution.

Tip

We recommend cleaning the weighing pan on a regular basis, e.g. weekly. Do not allow deposits to form on the weighing pan.

Protective oil may be applied to the weighing pan for additional protection. The protective oil must be suitable for stainless steel and titanium.

9.3 Assembling and Connecting the Device

Procedure

- ▶ Re-insert all components into the device (for insertion, see, Chapter "5.6 Positioning the Weighing Pan and Associated Components", page 26).
- ▶ Re-connect the device to the power supply (see Chapter "6.3 Connecting the Power Supply", page 27).

9.4 Maintenance Schedule

Interval	Component	Action	Chapter, page
Monthly to every 2 years, depending on the operating conditions	Entire system	Contact Sartorius Service	17, 66

9.5 Performing a Software Update

A software update can be installed from a USB mass storage device using the device's USB-A connection.

Requirements

- The device is switched on.
- The software update is saved on a USB mass storage device.

Procedure

- ▶ Download the software update from the Sartorius website onto the USB mass storage device.
- ▶ If this relates to a zip file: Unzip the software update on a USB stick.
- ▶ Insert the USB mass storage device with the software update into the device's USB-A connection.
- ▶ Access the configuration menu and select the [UPDATE] main menu.
- ▶ In the [UPDATE] main menu, select the [EXECUTE?] parameter.
- ▷ The [COPYING] display appears in the operating display.
- ▷ The [REBOOT] display appears in the operating display and the device restarts.
- ▷ The [UNPACK] display appears in the operating display.
- ▷ The [RESTART] display appears in the operating display and the device restarts.
- ▷ During the restart, the [CHECK.APC] display appears first. The [PROG APC] display then appears in the operating display for about 2 minutes.
 - ▶ Do **not** switch off the device!
- ▷ The device confirms successful installation with the [PROG OK] display.
- ▷ All identified components are updated with the new firmware.
- ▷ The device confirms the end of the installation process with the [FINISH] display.
- ▷ The device restarts.
- ▷ The device is ready for use.

10 Malfunctions

10.1 Status Messages

Status Message	Fault	Cause	Remedy	Chapter, page
OLDER?	If a USB mass storage device with a software update is connected: The device detects an obsolete update version.	The software update version is older than the software version on the device.	To perform the update anyway: Confirm the display.	
LOCKED	A software update is to be installed on a conformity-assessed device.	Software updates are not permitted for conformity-assessed devices.	If the software update has received corresponding approval: The software update can be uploaded into the device by Sartorius Service. Re-verification may then be necessary.	
INVALID.	If a USB mass storage device with a software update is connected: The device cannot find a valid update.	No valid manufacturer software updates exist on the connected USB mass storage device.	Check whether files exist on the USB mass storage device. Procure the software update files from Sartorius Service.	

10.2 Warning Messages

Warning Message	Fault	Cause	Remedy	Chapter, page
APP.ERR.	The device has measured an invalid weight value.	The applied weight is too low. The weight value is negative. No sample has been placed on the balance.	Increase the applied weight to more than the minimum load. Place the sample on the balance.	
DIS.ERR.	The value to be output cannot be shown in the operating display.	The data to be displayed is not compatible with the set display format.	Adjust the display settings in the menu, e.g. resolution, unit, decimal places.	
HIGH	The device is overloaded.	The device's maximum weighing capacity has been exceeded	Reduce the applied weight to below the device's maximum weighing capacity.	
LEVEL.ERR.	The device is not measuring a weight value.	The device is not leveled.	Level the device.	8.2, 39
LOW	The modulation of the weighing converter inside the weighing module is too low.	No weighing pan has been placed on the balance. A previously forgotten weight was removed after starting the device.	Insert the weighing pan into the device and switch the device off and on again.	
ERR 54		An error exists in the weighing system or in the device electronics.	Contact Sartorius Service.	

Warning Message	Fault	Cause	Remedy	Chapter, page
CHK.ERR.	The internal storage medium is faulty.	A memory error exists in the firmware.	Perform a software update. If the problem occurs again: Contact Sartorius Service.	9.5, 49
COMM.ERR.	The device is not receiving any weight values.	No communication exists between the control unit and the weighing module.	Wait until the control unit restores the communication with the weighing module. If the problem occurs again: Contact Sartorius Service.	
ELISE.ERR.	No communication with the inclination sensor.	A memory error exists in the firmware.	Switch the device off and on again. If the problem occurs again: Contact Sartorius Service.	
MOTOR.ERR.	The device cannot be leveled.	The device's incline is too great or a motorized foot is defective.	Change the installation site. If the problem occurs again: Contact Sartorius Service.	
PRT.ERR.	The [Print] key is locked.	The data interface for print output is set to xBPI mode.	Reset the menu to the factory settings. If the problem occurs again: Contact Sartorius Service.	
SYS.ERR.	The system data is faulty.	A memory error exists in the control unit.	Switch the device off and on again. If the problem occurs again: Contact Sartorius Service.	
ERR 02	The device cannot be calibrated when starting the calibration function due to a zero point error.	The device was not tared or zeroed before calibration. The device is loaded.	Tare or zero the device. Check the preload and set if necessary. Remove the sample from the weighing pan.	
ERR 10	Taring is not possible.	The device cannot be manually tared because an application program has the tare memory reserved.	To release the tare memory: Exit the application program with the [Back] button.	
ERR 11	The weight value cannot be saved in the tare memory.	The weight value is negative or "zero".	Check the sample being weighed. Zero the device before placing the sample on the balance if necessary.	
ERR 520 to ERR 527	The component replacement is faulty. The software update could not be completed.	The firmware versions of the available components do not match.	Check the device's firmware. Perform a software update. If the problem occurs again: Contact Sartorius Service.	9.5, 49

10.3 Troubleshooting

Fault	Cause	Remedy	Chapter, page
The operating display is blank.	The device is disconnected.	Check the connection to the power supply.	6.3, 27
	The AC adapter is not connected.	Connect the power supply cable to the power supply.	6.3, 27
The displayed weight value changes constantly.	The installation site is unstable.	Adjust the parameter for the ambient conditions.	
	A foreign object is positioned between the weighing pan and the housing.	Remove the foreign object.	5.2, 23
The weight readout displayed by the device is obviously wrong.	The device was not calibrated.	Calibrate the device.	
	The device was not tared before weighing.	Tare the device.	
The [Leveling] display flashes.	The device must be leveled.	Level the device.	8.2, 39
For a conformity-assessed device: The [Invalid weight value] display appears.	The cause of this fault is displayed after pressing the [Change] key. At the same time, the "Toggle between weight units" function is locked.		
	– LEVEL.ERR.: The device must be leveled.	Level the device.	8.2, 39
	– ISOCAL.ER.: The device must be calibrated.	Calibrate the device.	
	– WARMUP.xx.: The device is in the warm-up phase and has not yet reached its operating temperature. xx = remaining time in minutes	Comply with the warm-up time after switching the device on.	5.2, 23
	– VALUE.ERR.: The displayed value is invalid.	Set the device to zero.	

11 Decommissioning

11.1 Decommissioning the Device

Procedure

- ▶ Turn the device off.
- ▶ Disconnect the device from the power supply.
- ▶ Disconnect the device from all connected devices and all accessories, e.g. printer or electronics module.
- ▶ Clean the device (see Chapter "9.2 Cleaning the Device", page 48).
- ▶ Re-insert all components into the device (see Chapter "9.1 Preparing the Device", page 48, Chapter "9.3 Assembling and Connecting the Device", page 49).
- ▶ If below-balance weighing has been set up:
 - ▶ Turn the device on its side and place it on a soft support base.
 - ▶ Remove the hook for below-balance weighing from the thread.
 - ▶ Insert below-balance cap (1) back into the opening (2) in the device base and screw in with a suitable screwdriver.
 - ▶ Insert the hook for below-balance weighing (2) into its retainer on the underside of the weighing module.
 - ▶ Re-insert the cover of the below-balance weighing equipment (1).
 - ▶ Place the device on the device base on a level surface.

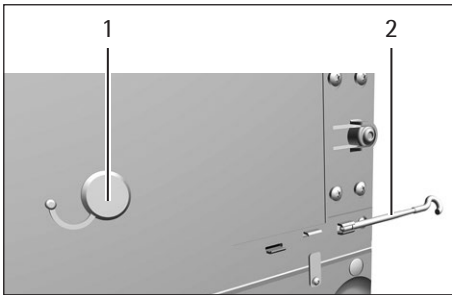

12 Transport

12.1 Transporting the Device

Procedure

- ▶ Only lift the device by its base.

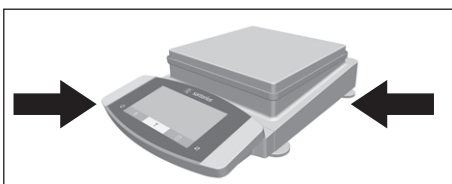

- ▶ When lifting and transporting, ensure that **no** personnel or objects are in the way.
- ▶ Get help from additional persons when lifting and transporting the device.
- ▶ Use suitable conveyance devices, e.g., trolleys, for long transport routes.

13 Storage and Shipping

13.1 Storage

Procedure

- ▶ Turn the device off.
- ▶ Disconnect the device from the power supply.
- ▶ Disconnect the device from all connected devices and all accessories, e.g. printer.
- ▶ Clean the device (see Chapter "9.2 Cleaning the Device", page 48).
- ▶ Store the device according to the ambient conditions (see Chapter 15.6, page 58).

13.2 Returning Device and Parts

Defective devices or device components can be returned to Sartorius. Returned devices must be clean, decontaminated, and properly packed, e.g. in the original packaging.

Transport damage as well as measures for subsequent cleaning and disinfection of the device or device components by Sartorius shall be charged to the sender.

WARNING

Risk of injury due to contaminated devices!

Devices contaminated with hazardous materials (nuclear, biological, or chemical – NBC) will **not** be accepted for repair or disposal.

- ▶ Observe the information on decontamination (see Chapter 14.1, page 55).
-

Procedure

- ▶ Disconnect the device from the power supply.
- ▶ Disconnect the device from all connected devices and all accessories, e.g. printer.
- ▶ Clean the device.
- ▶ Contact Sartorius Service for instructions on how to return devices or device components (please refer to www.sartorius.com for return instructions).
- ▶ Pack the device and the device components properly for return, e.g. in the original packaging.

14 Disposal

14.1 Information on Decontamination

The device does **not** contain any hazardous materials that would necessitate special disposal actions.

Contaminated samples used during the process are potentially hazardous materials that could cause biological or chemical hazards.

If the device has come into contact with hazardous substances: Steps must be taken to ensure proper decontamination and declaration. The operator is responsible for adhering to local government regulations on the proper declaration of transport and disposal and the proper disposal of the device.

WARNING

Risk of injury due to contaminated devices!

Devices contaminated with hazardous materials (NBC contamination) will **not** be accepted by Sartorius for repair or disposal.

14.2 Dispose of Device and Parts

14.2.1 Information on Disposal

The device and the device accessories must be disposed of properly by disposal facilities.

A lithium cell battery, type CR2032, is installed inside the device. Batteries must be disposed of properly by disposal facilities.

The packaging is made of environmentally friendly materials that can be used as secondary raw materials.

14.2.2 Disposal

Requirements

The device has been decontaminated.

Procedure

- ▶ Dispose of the device. Follow the disposal instructions on our website (www.sartorius.com).
- ▶ Inform the disposal facility that there is a lithium cell battery, type CR2032, installed inside the device.
- ▶ Dispose of the packaging in accordance with local government regulations.

15 Technical Data

15.1 Dimensions and Weight

15.1.1 Precision Balance

	Unit	Value
Dimensions (L x W x H)	mm	425 x 240 x 95
Weighing pan size	mm	206 x 206
Weight, approx.	kg	5.4

15.2 Power Supply

15.2.1 Device

Only by Sartorius AC adapter YEPS03-15V0

15.2.2 Power Supply Unit

	Unit	Value
Item No.		YEPS03-15V0
Primary		
AC voltage	V	100 – 240 (±10%)
Frequency	Hz	50 – 60 (±5%)
Current consumption, maximum	A	1.0
Secondary		
DC voltage at 2 A output current	V	14.25 – 15.75
Power, maximum	W	30
Short circuit protection: Electronic		
Protection class according to IEC 62368-1		I
Pollution level according to IEC 61010-1		2
Overvoltage category according to IEC 606641-1		II
Installation site according to IEC 62368-1, maximum altitude above sea level	m	5000
Temperature		
In operation	°C	0 – +40
During storage and transport	°C	-20 – +80
Connector for mains connection according to IEC 60320-1 / C14: 3-pin		
Power supply cable		
Power supply cable according to IEC 60320-1 / C14: Country-specific, 3-pin, two-sided plug		
Other data: See label on AC adapter		

15.2.3 Safety of Electrical Equipment

According to EN 61010-1/IEC 61010-1 Safety requirements for electrical equipment for measurement, control, and laboratory use – Part 1: General Requirements

15.2.4 Electromagnetic Compatibility

Interference resistance

Suitable for use in industrial areas

Transient emissions

Class B

Suitable for use in residential areas and areas that are connected to a low voltage network that also supplies residential buildings.

15.3 Materials

Housing: Die-cast aluminum, plastic PBT, Optiwhite float and stainless steel 1.4401 | 1.4404, PA handles, aluminum trim

Control unit: Plastic PBT, float glass and stainless steel 1.4301

15.4 Integrated Clock

	Unit	Value
Maximum deviation per month (RTC)	s	30

15.5 Backup Battery

	Unit	Value
Lithium battery, type CR2032		
Service life at room temperature, minimum	Years	10

15.6 Ambient Conditions

15.6.1 Installation Site

	Unit	Value
Installation site		
Standard laboratory rooms		
Installation site according to IEC 60259-1, maximum altitude above sea level	m	3000
For indoor use only		
Temperature		
In operation	°C	+5 – +40
In operation for conformity-assessed devices: See information on the device's ID plate		
During storage and transport	°C	-20 – +60
Relative humidity		
At temperatures of up to 31 °C	%	80
Then linear decrease from 80 % at 31 °C to 50 % at 40 °C		
No heat from heating systems or direct sunlight		
No drafts from open windows, AC systems, or doors		
No vibrations		
No "heavy traffic" areas (personnel)		
No electromagnetic fields		
No dry air		

15.6.2 Ambient Temperature for the isoCAL Function

	Unit	MCE14202S Value	MCE14202P Value	MCE10202S Value	MCE8202S Value
Scope of application as per Directive 2014/31/EU					
With isoCAL function	°C	+10 – +30	+10 – +30	+10 – +30	+10 – +30
Without isoCAL function	°C	+17 – +27	+17 – +27	+17 – +27	+10 – +30
	Unit	MCE6202S Value	MCE6202P Value	MCE4202S Value	MCE2202S Value
Scope of application as per Directive 2014/31/EU					
With isoCAL function	°C	+10 – +30	+10 – +30	+10 – +30	+10 – +30
Without isoCAL function	°C	+10 – +30	+10 – +30	+10 – +30	+10 – +30
	Unit	MCE1202S Value	MCE12201S Value	MCE8201S Value	MCE5201S Value
Scope of application as per Directive 2014/31/EU					
With isoCAL function	°C	+10 – +30	+10 – +30	+10 – +30	+10 – +30
Without isoCAL function	°C	+10 – +30	+10 – +30	+10 – +30	+10 – +30

15.6.3 Protection Class

	Value
IP protection according to IEC 60529-1	IP 54

15.7 Metrological Data

15.7.1 Models MCE14202S | MCE14202P | MCE10202S | MCE8202S

		MCE14202S	MCE14202P	MCE10202S	MCE8202S
	Unit	Value	Value	Value	Value
Scale interval (d)	mg	10	10 20 50	10	10
Maximum capacity (Max)	g	14200	3500 7000 14200	10200	8200
Repeatability at 5 % load					
Standard deviation of the load values, tolerance	mg	10	10	7	7
Standard deviation of the load values, typical value	mg	5	5	5	4
Repeatability at approx. maximum capacity					
Standard deviation of the load values, tolerance	mg	10	10	7	7
Standard deviation of the load values, typical value	mg	5	5	5	4
Linearity deviation					
Tolerance	mg	30	50	20	20
Typical value	mg	10	20	6	6
Deviation when load is off-center, positions according to OIML R76					
Test weight	g	5000	5000	5000	5000
Tolerance	mg	20	40	20	30
Typical value	mg	10	10	10	10
Sensitivity drift between +10 °C and +30 °C	ppm/K	1.5	1.5	1.5	2
Tare-maximum capacity: Less than 100 % of maximum capacity					
Accuracy class according to Directive 2014/31/EU		I	I	I	II
Verification scale interval (e) according to Directive 2014/31/EU	g	0.1	0.1	0.1	0.1
Minimum load (Min) according to Directive 2014/31/EU	g	1	1	1	0.5
Minimum initial weighing according to USP (United States Pharmacopeia), Chap. 41					
Optimum minimum initial weighing	g	8.2	8.2	8.2	8.2
Typical minimum initial weighing	g	8.2	8.2	8.2	8.2
Typical stabilization time	s	0.8	0.8	0.8	1
Typical measurement time	s	1.5	1.5	1.5	1.5

15.7.2 Models MCE6202S | MCE6202P | MCE4202S | MCE2202S

		MCE6202S	MCE6202P	MCE4202S	MC2202S
	Unit	Value	Value	Value	Value
Scale interval (d)	mg	10	10 20 50	10	10
Maximum capacity (Max)	g	6200	1500 3000 6200	4200	2200
Repeatability at 5 % load					
Standard deviation of the load values, tolerance	mg	7	7	7	7
Standard deviation of the load values, typical value	mg	4	4	4	4
Repeatability at approx. maximum capacity					
Standard deviation of the load values, tolerance	mg	7	40	7	7
Standard deviation of the load values, typical value	mg	4	15	4	4
Linearity deviation					
Tolerance	mg	20	50	20	20
Typical value	mg	6	20	6	6
Deviation when load is off-center, positions according to OIML R76					
Test weight	g	2000	2000	2000	1000
Tolerance	mg	20	30	30	20
Typical value	mg	10	30	10	10
Sensitivity drift between +10 °C and +30 °C	ppm/K	2	2	2	2
Tare-maximum capacity: Less than 100 % of maximum capacity					
Accuracy class according to Directive 2014/31/EU		II	II	II	II
Verification scale interval (e) according to Directive 2014/31/EU	g	0.1	0.1	0.1	0.1
Minimum load (Min) according to Directive 2014/31/EU	g	0.5	0.5	0.5	0.5
Minimum initial weighing according to USP (United States Pharmacopeia), Chap. 41					
Optimum minimum initial weighing	g	8.2	8.2	8.2	8.2
Typical minimum initial weighing	g	8.2	8.2	8.2	8.2
Typical stabilization time	s	1	1	1	0.8
Typical measurement time	s	1.5	1.5	1	1.5

15.7.3 Models MCE1202S | MCE12201S | MCE8201S | MCE5201S

		MCE1202S	MCE12201S	MCE8201S	MC5201S
	Unit	Value	Value	Value	Value
Scale interval (d)	mg	10	100	100	100
Maximum capacity (Max)	g	1200	12200	8200	5200
Repeatability at 5 % load					
Standard deviation of the load values, tolerance	mg	7	50	50	50
Standard deviation of the load values, typical value	mg	4	20	20	20
Repeatability at approx. maximum capacity					
Standard deviation of the load values, tolerance	mg	7	50	50	50
Standard deviation of the load values, typical value	mg	4	20	20	20
Linearity deviation					
Tolerance	mg	20	100	100	100
Typical value	mg	6	30	30	20
Deviation when load is off-center, positions according to OIML R76					
Test weight	g	500	5000	5000	2000
Tolerance	mg	20	200	200	200
Typical value	mg	10	100	100	100
Sensitivity drift between +10 °C and +30 °C	ppm/K	2	4	4	4
Tare-maximum capacity: Less than 100 % of maximum capacity					
Accuracy class according to Directive 2014/31/EU		II	II	II	II
Verification scale interval (e) according to Directive 2014/31/EU	g	0.1	1	1	1
Minimum load (Min) according to Directive 2014/31/EU	g	0.5	5	5	5
Minimum initial weighing according to USP (United States Pharmacopeia), Chap. 41					
Optimum minimum initial weighing	g	8.2	82	82	82
Typical minimum initial weighing	g	8.2	82	82	82
Typical stabilization time	s	0.8	0.8	0.8	0.8
Typical measurement time	s	1	1	1	1

15.8 Recommended Calibration Weight

		MCE14202S	MCE14202P	MCE10202S	MCE8202S
	Unit	Value	Value	Value	Value
External test weight	g	14000	14000	10000	7000
Recommended accuracy class		E2	E2	E2	E2

		MCE6202S	MCE6202P	MCE4202S	MCE2202S
	Unit	Value	Value	Value	Value
External test weight	g	5000	5000	3000	1500
Recommended accuracy class		E2	E2	E2	E2

		MCE1201S	MCE12201S	MCE8201S	MCE5201S
	Unit	Value	Value	Value	Value
External test weight	g	700	12000	8000	5000
Recommended accuracy class		E2	F1	F1	F1

15.9 isoCAL Function

15.9.1 Models MCE14202S | MCE14202P | MCE10202S

	Unit	Value
isoCAL is triggered by the following criteria:		
In the event of a temperature change	K	1.5
After a time interval	h	12
After successful leveling		

15.9.2 Models MCE8202S | MCE6202S | MCE6202P | MCE4202S | MCE2202S | MCE1202S

	Unit	Value
isoCAL is triggered by the following criteria:		
In the event of a temperature change	K	2
After a time interval	h	12
After successful leveling		

15.9.3 Models MCE12201S | MCE8201S | MCE5201S

	Unit	Value
isoCAL is triggered by the following criteria:		
In the event of a temperature change	K	4
After a time interval	h	12
After successful leveling		

15.10 Interfaces

15.10.1 Specifications for the COM-RS232 Interface

Type of interface: Serial interface

Interface operation: Full duplex

Level: RS232

Connection: D-sub connector, 9-pin

Maximum cable length: 10 m

Pin assignment

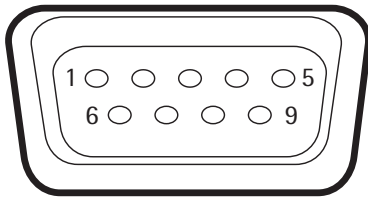

Pin 1: **Not** assigned
 Pin 2: Data output (TxD)
 Pin 3: Data input (RxD)
 Pin 4: **Not** assigned
 Pin 5: Internal ground
 Pin 6: **Not** assigned
 Pin 7: Clear to Send (CTS)
 Pin 8: Request to Send (RTS)
 Pin 9: **Not** assigned

15.10.2 Specifications for the USB-A Interface

Communication: USB host (master)

Connectable devices: Sartorius printers, USB sticks with software update

15.10.3 Specifications for the USB-B Interface

Communication: USB device (slave)

Type of interface: Virtual serial interface (virtual COM-port, VCP) and "PC direct" communication

16 Accessories

16.1 Accessories

This table contains an excerpt of the accessories that can be ordered. For information on other products, contact Sartorius.

16.1.1 Printers and Communication

Item	Quantity	Order number
Thermal transfer thermal printer for GLP/GMP printouts on continuous paper and labels	1	YDP30
Standard paper and ink ribbon, set, 90 m, for YDP30	1	69Y03285
Self-adhesive paper and ink ribbon, 90 m, for YDP30	1	69Y03286
Standard thermal paper, 24 m roll, for YDP30 YDP40	5	69Y03287
Self-adhesive thermal paper, 13 m roll, for YDP30	5	69Y03288
Self-adhesive labels for YDP30		
58 mm x 100 mm	350	69Y03094
58 mm x 76 mm	500	69Y03093
58 mm x 30 mm	1000	69Y03092
Display cable, 3 m, for separate installation of display and weighing units, installation by Sartorius Service or at the factory (order code VF4016)	1	On request
Installation of display cable, 3 m, for separate installation of display and weighing units	1	VF4016
Cable, 3 m, between the weighing module and electronics module for semi-microbalance	1	YCC01-MSM3
RS232C connection cable, 9-pin, 3 m, for connection to a PC with 9-pin COM port	1	On request
Sartorius Wedge, software for data communication between the PC and balance	1	YSW02

16.1.2 Displays and Input/Output Elements

Item	Quantity	Order number
Display and control unit with color TFT graphic display and touch screen	1	YAC01MCA
Motion sensor for triggering a maximum of 4 functions via gesture control, selection via menu	1	YHS02MS

16.1.3 Special Applications

Item	Quantity	Order number
Density determination set for solids and liquids for precision balance	1	YDK04MS

16.1.4 Weighing Tables

Item	Quantity	Order number
Weighing table made from synthetic stone, with vibration dampening	1	YWT03
made from wood with synthetic stone	1	YWT09
Wall console	1	YWT04

16.1.5 Weighing Accessories

Item	Quantity	Order number
Weighing scoop made from chrome-nickel steel, L 90 mm x W 32 mm x H 8 mm	1	641214

Item	Quantity	Order number
Stand For weighing modules with scale intervals of 10 mg 100 mg for raising the operating unit	1	YDH03MS

17 Sartorius Service

Sartorius Service is available for queries regarding the device. For information about the service addresses, services provided, or to contact a local representative, please visit the Sartorius website (www.sartorius.com).

When contacting Sartorius Service with questions about the system or in the event of malfunctions, be sure to have the device information, e.g., serial number, hardware, firmware, configuration, close at hand. Consult the information on the manufacturer's ID label and in the "Device Information" menu (see Chapter "4.5.1 Overview of the Device Settings Menu", page 17).

18 Conformity & Certificates

18.1 EU Declaration of Conformity

The attached Declaration of Conformity hereby confirms compliance of the device with the directives cited.



The declaration of conformity supplied here is for conformity-assessed (verified) balances for use in the EEA. Please keep it in a safe place.



Original

EG-/EU-Konformitätserklärung EC / EU Declaration of Conformity

Hersteller
Manufacturer

Sartorius Lab Instruments GmbH & Co. KG
37070 Goettingen, Germany

erklärt in alleiniger Verantwortung, dass das Betriebsmittel
declares under sole responsibility that the equipment

Geräteart
Device type

Elektronische Präzisions-, Milligramm-, Analysen-, Semimikro-, Mikro-Klein- und Hochlastwaage
Electronical Precision, Milligram, Analytical, Semi micro, Micro-Small, and High-Capacity Balance

Baureihe
Type series

MCAvw-2x-y, MCEvw-2x-y,
v = 2.7, 3.6, 6.6, 10.6, 124, 125, 224, 225, 323, 324, 524, 623, 1202, 1203, 2202, 2203, 3203, 4202,
5201, 5202, 5203, 6202, 8201, 8202, 10202, 11201, 12201, 14202, 20201, 32202, 36200, 36201,
50201, 70200, 70201;
w = S, P; x = S00, S01, CEU, CFR, CCN, OBR, OIN, ORU, OJP; y = A, E, F, I, M, O, R, U

in der von uns in Verkehr gebrachten Ausführung allen einschlägigen Bestimmungen der folgenden Europäischen Richtlinien – einschließlich deren zum Zeitpunkt der Erklärung geltenden Änderungen – entspricht und die anwendbaren Anforderungen folgender harmonisierter Europäischer Normen erfüllt:
in the form as delivered fulfils all the relevant provisions of the following European Directives – including any amendments valid at the time this declaration was signed – and meets the applicable requirements of the harmonized European Standards listed below:

2014/30/EU

Elektromagnetische Verträglichkeit
Electromagnetic compatibility
EN 61326-1:2013

2006/42/EG
2006/42/EC

Maschinen
Machines
EN ISO 12100:2010, EN 61010-1:2010

2011/65/EU

Beschränkung der Verwendung bestimmter gefährlicher Stoffe in Elektro- und Elektronikgeräten (RoHS)
Restriction of the use of certain hazardous substances in electrical and electronic equipment (RoHS)
EN 50581:2012

Die Person, die bevollmächtigt ist, die technischen Unterlagen zusammenzustellen:

The person authorised to compile the technical file: Sartorius Lab Instruments GmbH & Co. KG
International Certification Management
37070 Goettingen, Germany

Jahreszahl der CE-Kennzeichenvergabe | *Year of the CE mark assignment:* 18

Sartorius Lab Instruments GmbH & Co. KG
Goettingen, 2018-06-20

Dr. Reinhard Baumfalk
Vice President R&D

Dr. Dieter Klausgrete
Head of International Certification Management

Diese Erklärung bescheinigt die Übereinstimmung mit den genannten EG- und EU-Richtlinien, ist jedoch keine Zusicherung von Eigenschaften. Bei einer mit uns nicht abgestimmten Änderung des Produktes verliert diese Erklärung ihre Gültigkeit. Die Sicherheitshinweise der zugehörigen Produktdokumentation sind zu beachten.

This declaration certifies conformity with the above mentioned EC and EU Directives, but does not guarantee product attributes. Unauthorised product modifications make this declaration invalid. The safety information in the associated product documentation must be observed.

Doc: 2369814-00 SLI18CE001-00.de,en 1 / 1 PMF: 2369813 OP-113_fo1_2015.10.12

18.2 Certificate of Compliance



Certificate of Compliance

Certificate: 70185847 **Master Contract:** 167555 (056628)
Project: 70185847 **Date Issued:** 2018-09-24
Issued to: Sartorius Lab Instruments GmbH & Co. KG
 Otto-Brenner-Strasse 20
 Goettingen, Niedersachsen 37079
 GERMANY

The products listed below are eligible to bear the CSA Mark shown with adjacent indicators 'C' and 'US' for Canada and US or with adjacent indicator 'US' for US only or without either indicator for Canada only.



Issued by: Jean-Philippe Laplante
 Jean-Philippe Laplante

PRODUCTS

CLASS - C872106 - ELECTRICAL LABORATORY EQUIPMENT

CLASS - C872186 - ELECTRICAL LABORATORY EQUIPMENT-Certified to US Standards

Digital scale, models: MCA Series & MCE Series; rated: 15Vdc, 12W max for external PS rated: 100-240Vac, 50-60Hz, 1.0A max

Notes:

1. The above model is Equipment Class I (powered by external class I power supply with detachable power supply cord), Pollution Degree 2 and Overvoltage category II
2. Mode of operation: Continuous
3. Environmental Conditions: 5 to 40 °C, 3000 m max, 80% rH max



Certificate: 70185847
Project: 70185847

Master Contract: 167555
Date Issued: 2018-09-24

APPLICABLE REQUIREMENTS

CSA Standards:

CAN/CSA-C22.2 No. 61010-1-12 - Safety Requirements for Electrical Equipment for Measurement, Control, and Laboratory Use, Part 1: General Requirements

UL Standards:

UL Std. No. 61010-1 (3rd Edition) - Safety Requirements for Electrical Equipment for Measurement, Control, and Laboratory Use - Part 1: General Requirements

CONDITIONS OF ACCEPTABILITY

- (1) Equipment is intended to be used with power supply FSP Group Inc, Model FSP030-DGAN3 or Sinpro Electronics Co Ltd, Model SPU31-106 or PSFD rated output 15Vdc, 2A. The equipment can also be used with any other power supply approved for Canada and USA under the 60950-1 or 61010-1 or equivalent standards and which provides Reinforced insulation between mains and secondary circuits. It must be rated for 3000m and up to 40°C and must provide an output of 15Vdc LPS with a minimum of 1A
- (2) Detachable cord set, to be delivered with the product, consisting of minimum NEMA 5-15 Plug, 3 x 18AWG cable and C13 Appliance coupler. For countries outside Canada and the USA the cable must be equivalent and must fulfill the national requirements for detachable cord sets.

18.3 FCC Supplier's Declaration of Conformity

FCC Supplier's Declaration of Conformity

Device type Electronical Precision, Milligram, Analytical, Semi Micro, Micro-Small and High-Capacity Balance

Type series **MCAvw-2x-y, MCEvw-2x-y**

v = 2.7, 3.6, 6.6, 10.6, 124, 125, 224, 225, 323, 324, 524, 623, 1202, 1203, 2202, 2203, 3203, 4202, 5201, 5202, 5203, 6202, 8201, 8202, 10202, 11201, 12201, 14202, 20201, 32202, 36200, 36201, 50201, 70200, 70201

w = S, P

x = S00, S01, CEU, CFR, CCN, OBR, OIN, ORU, OJP

y = A, E, F, I, M, O, R, U

**Party issuing Supplier's Declaration of Conformity /
Responsible Party – U.S. Contact Information**

Sartorius Corporation
5 Orville Dr Suite 200
11716 Bohemia, NY
USA
Telephone: +1.631.254.4249

FCC Compliance Statement

This device complies with Part 15 of the FCC Rules. Operation is subject to the following two conditions: (1) This device may not cause harmful interference, and (2) this device must accept any interference received, including interference that may cause undesired operation.

Information to the user

This equipment has been tested and found to comply with the limits for a **class B** digital device, pursuant to part 15 of the FCC Rules. These limits are designed to provide reasonable protection against harmful interference in a residential installation. This equipment generates, uses and can radiate radio frequency energy and if not installed and used in accordance with the instructions, may cause harmful interference to radio communications. However, there is no guarantee that interference will not occur in a particular installation. If this equipment does cause harmful interference to radio or television reception, which can be determined by turning the equipment off and on, the user is encouraged to try to correct the interference by one or more of the following measures:

- Reorient or relocate the receiving antenna.
- Increase the separation between the equipment and receiver.
- Connect the equipment into an outlet on a circuit different from that to which the receiver is connected.
- Consult the dealer or an experienced radio/TV technician for help.

Connections between the device and peripherals must be made using shielded cables in order to maintain compliance with FCC radio frequency emission limits.

Any modifications made to this device that are not approved by Sartorius may void the authority granted to the user by the FCC to operate this equipment.

Doc: 2384181-00 SLI18FCC001-00.en 1 / 1 PMF: 2369813 OP-113_fo1_2015.10.12

Sartorius Lab Instruments GmbH & Co. KG
Otto-Brenner-Strasse 20
37079 Goettingen, Germany

Phone: +49.551.308.0
www.sartorius.com

The information and figures contained in these instructions correspond to the version date specified below.

Sartorius reserves the right to make changes to the technology, features, specifications and design of the equipment without notice.

Masculine or feminine forms are used to facilitate legibility in these instructions and always simultaneously denote the other gender as well.

Copyright notice:

This instruction manual, including all of its components, is protected by copyright.

Any use beyond the limits of the copyright law is not permitted without our approval.

This applies in particular to reprinting, translation and editing irrespective of the type of media used.

© Sartorius Germany

Last updated:

11 | 2018