

micro^{TS}

(Micro Temperature Sealer)



Instructions for Use



This Manual Copyright © 2013 ITL

All rights reserved. No part of this manual may be reproduced, stored in a retrieval system, or transmitted, by any means or in any form, without the prior permission of Integrated Technologies Limited (ITL).

The information contained in this manual is subject to change without notice. ITL assumes no responsibility for any errors that may appear in this or related documentation.

Document: V501004
Revision: 6-1311

Vitl is the brand name for Integrated Technologies' own range of laboratory products. For further details please visit our Vitl web site.

www.vitl.co.uk









All sales and technical enquiries should be addressed to:

VITL Customer Services
Integrated Technologies Limited
Viking House
Ellingham Way
Ashford
Kent
TN23 6NF
United Kingdom

+44 (0)1233 638383
sales@vitl.co.uk

1 Symbols Used in this Instruction Manual

The following advisory symbols are used in this manual.

Table 1: Advisory Symbol Meanings	
 DANGER	Indicates a Risk of Electric Shock which could, if not avoided, result in severe injury or death.
 DANGER	Indicates a Burn Hazard which could, if not avoided, result in severe injury or death.
 DANGER	Indicates a Risk of Explosion which could, if not avoided, result in severe injury or death.
 WARNING	Indicates a hazardous situation which could, if not avoided, result in severe injury or death; or severely damage the unit.
 CAUTION	Indicates a hazardous situation which could, if not avoided, result in minor or moderate injury; or degrade or impair the functionality of the unit.
 CAUTION	Indicates a Risk of Crush hazard due to moving parts which could, if not avoided, result in minor or moderate injury.
	Advisory note or other useful information.
	Refer to “section NN” for more details.

2 Safety Precautions and Limitations of Use

It is essential that all users of this equipment have fully read and understood the following safety precautions and limitations of use before installing or operating the Micro^{TS} unit.

IMPORTANT



WARNING

The protection provided by this equipment may be impaired if it is not used in a manner described in this manual.



WARNING

It is essential that the user of this equipment is aware of the potential hazards associated with the unit and its accessories.

All operators should be familiar with the safety precautions and warnings given in these instructions before attempting to operate the unit.

Improper use of this unit or its accessories may impair their functionality and invalidate the manufacturer's warranty.

Unit Handling Precautions



CAUTION

Care should be taken not to drop the unit or subject it to rough physical handling, both during normal use and during transportation and storage.



WARNING

The unit should be held by the handle when being lifted or moved. Do not lift the unit by any other part of the casework.

Care should be taken when lifting due to the unit's weight.

Unit Installation and Operating Environment



DANGER

The Micro^{TS} unit is designed for indoor laboratory use only.

The acceptable operating temperature range is 18°C to 30°C, with a relative humidity of 20% to 80% non-condensing, at a maximum altitude of 2200m above sea level.



WARNING

If the unit is stored in conditions outside of these ranges, it must be left to stand unpowered until it has acclimatised to within these environmental limits before being powered.

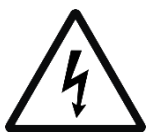

DANGER

Use only the AC mains power cord provided with the unit or as specified section 9.

The unit must be connected to a suitably earthed mains supply, with appropriate earth-leakage and over-current protection.



WARNING

Always ensure that the mains power connector is securely inserted into the rear of the unit, and any excess power cord does not pose a potential trip or pull hazard.



DANGER

Do not operate the unit in any area which is, or has been, or is thought to have been exposed to explosive or flammable gases, vapours or liquids.



WARNING

The unit must be installed and operated on a solid, stable and level working surface.

General Operating Precautions**DANGER**

Ensure that the power is switched off at both the AC mains supply outlet and at the back of the unit before inserting or removing the mains power cord.

**DANGER**

The heater plate reaches a temperature of 170°C and will remain hot for a considerable time after being turned off.

Extreme care must be taken not to touch the heater plate as it will cause a severe burn injury.

**DANGER**

The unit is intended for use with plates containing biological samples only.

Never use the unit to seal any explosive, volatile or highly reactive substances or chemicals.

**CAUTION**

There is a possible finger crush hazard due to the moving parts of the handle and plate carrier.

Care should be taken when operating the handle.

Unit Maintenance and Serviceability



DANGER

There are no user or operator serviceable parts inside the unit.

Do not remove the unit casework.



WARNING

Removal of the unit's casework will void the manufacturer's warranty and may expose the user to a Risk of Electric Shock resulting in serious injury or death.



DANGER

Once installed, the externally accessible unit fuse will only blow under a fault condition. This fuse should only be changed after the unit has been thoroughly inspected by a qualified engineer. See section 7.1 for details.



DANGER

Always switch off the unit and disconnect the power cord before performing any cleaning or decontamination procedure.

If liquid is spilt into or over the unit, switch off and disconnect the power from the AC mains outlet before attempting to deal with the spillage.



CAUTION

Ensure that the heater plate has cooled down to room temperature before performing any cleaning operation and before moving or storing the unit.



CAUTION

The use of harsh chemicals and cleaning agents may damage the unit and degrade its performance.

Always follow the cleaning and decontamination procedures specified in sections 7.3 and 7.4 of this instruction manual.



CAUTION

Do not autoclave any part of the unit or its accessories.

3 Regulatory Limitations of Use

Declaration of Conformity



ELECTRICAL SAFETY
E113628

Integrated Technologies Limited (ITL) affirm that this product fulfils the essential requirements of the Low Voltage Directive (LVD) 2006/95/EC and the EMC Directive 2004/108/EC, when installed and operated in accordance with the instructions in this manual.

The Micro^{TS} unit has been type tested by Trac Global (UKAS approved test facility and UK appointed Notified Body) against the EMC Requirements listed below, and issued Certificate No 6660/10 and 6661/10.

Safety and EMC Requirements

SAFETY

- EN 61010-1:2010, EN 61010-2-051:2003
- UL 61010-1:2001 2nd Edition (CAN C22.2 CSA 61010-1)

EMC

- EN 61326:2006, Class B
- FCC CFR 47 Parts 15.107 and 15.109, Class B

WEEE Directive Compliance



WEEE

Where applicable, the Micro^{TS} unit should be disposed of in accordance with the European Union WEEE Directive 2002/96/EC on Waste Electrical and Electronic Equipment.

Do not dispose of this product into unsorted municipal waste or public landfill. Please refer to section 7.6 for details of how to correctly dispose of this product.

The Micro^{TS} unit is designed and manufactured under ISO 9001 by:

Integrated Technologies Limited

Viking House, Ellingham Way, Ashford, Kent, TN23 6NF
United Kingdom

4 Unit Description

The Micro^{TS} fixed temperature sealer provides a safe and controlled method for sealing plastic sample plates to protect the samples from evaporation and contamination during storage.

The unit has the following external features:

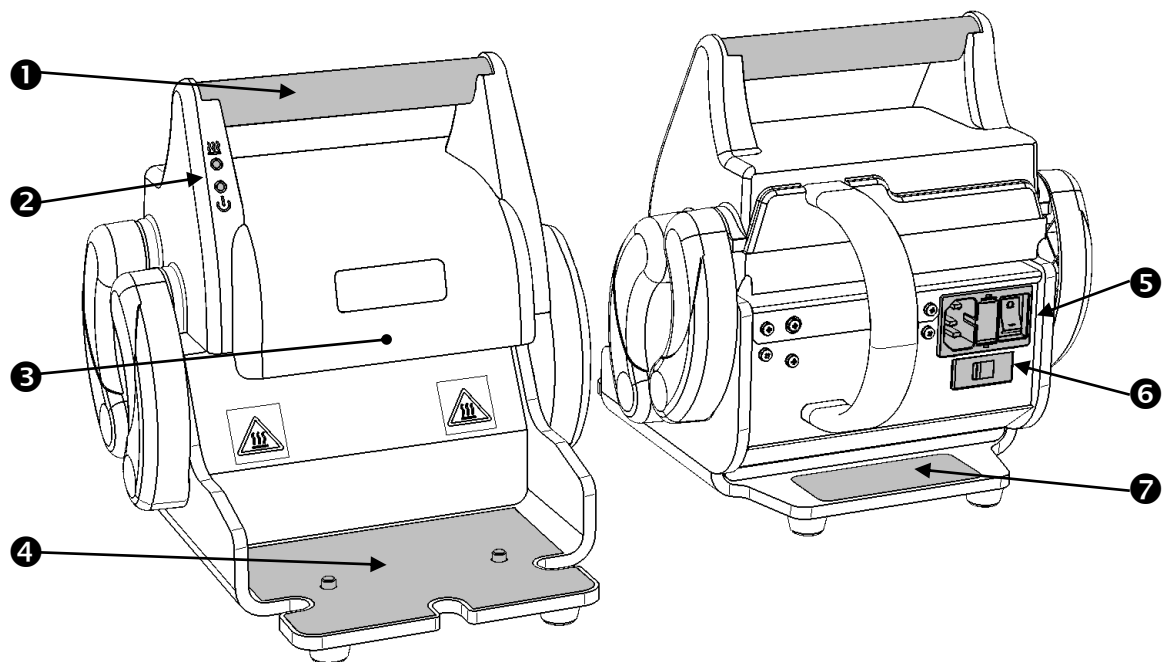
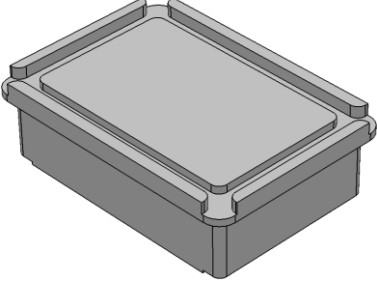
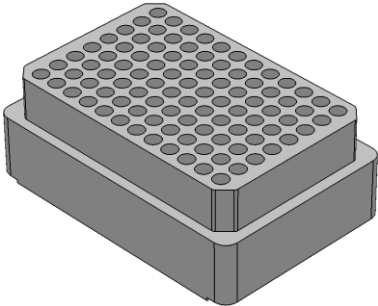
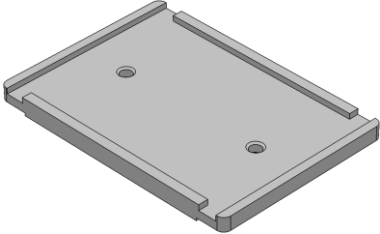

Table 2: Unit Features

1	Seal Activation Handle	⇒ 6.2
2	Status Indicator LEDs	⇒ 6.1
3	Heater Plate (Internal)	⇒ 6.2
4	Adaptor Plate Carrier	⇒ Table 3
5	Power Inlet, On/Off Switch and Fuse Holder	⇒ 5
6	Mains Voltage Selector	⇒ 5
7	Product Information Label	⇒ 9

The Micro^{TS} unit is designed to be used with a range of sample plates and consumables – some of which are listed below:

Table 3: Plate and Adaptor Types	
Adaptor Type	Suitable Plate Types
	96 Well Microtiter Plate 384 Well Microtiter Plate PCR 96 Well Skirted Plate
	PCR 96 Well Semi-skirted Plate PCR 96 Well Unskirted Plate
	Deepwell Plates
Plate Material Types	Polypropylene, Polyethylene or Polystyrene

Other specialist adaptor plates may be available on request. Please contact your distributor for details.

Table 4: Recommended Film and Foil Types	
Films	Clear Polyester/Polypropylene Laminate Clear Polymer Thin Clear Polymer
Foils	Foil Polypropylene Laminate Foil Laminate Foil

A comprehensive range of VITL clear films and foils are available. Please contact your distributor for details.

5 Unit Installation

Before installing the Micro^{TS} unit, please check that the delivery is complete and that the unit and any accessory parts are intact and free from any signs of transportation damage. Also ensure that all external and internal packaging has been removed from the unit before installation.



Please retain all packaging for future transportation and storage of the unit and its accessories.

The Micro^{TS} unit should be installed in a location which meets the following requirements:



- Safe and suitable operating environment (see section 2)
- Solid, stable, level working surface
- At least 10cm clearance around the unit to adjacent objects and walls
- Earthed AC mains power connection (see section 9)



WARNING

Please also observe and abide by the **Unit Installation and Operating Environment** safety precautions and preconditions listed in section 2.

It is important the check that the Mains Voltage Selector switch on the rear of the unit has been set to the correct position for the desired operating voltage, and the correct value of fuse has been fitted (see Table 5).

Table 5: Mains Voltage Selection		
Operating Voltage	110 to 120 VAC	220 to 230 VAC
Voltage Selection See Section 4 for switch location (ⓐ) on unit rear panel.	115 	230 
Fuse Rating	3.15AH	1.6AH

**WARNING**

Ensure that the correct fuse type has been fitted in the mains inlet fuse holder for the desired voltage selector switch value. See Table 5 for details.

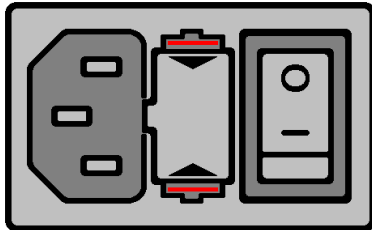

1. Remove the AC plug from the power inlet module
2. Use a small flat bladed screwdriver to push the two securing tabs inwards (highlighted in red) and pull out the fuse holder
3. Fit the correct fuse in the lower position only
4. Push fuse holder back into mains inlet module

Install and test the Micro^{TS} unit using the following procedure:

- 1) Place the unit on the suitably selected working surface (as specified above).
- 2) Connect the unit to the AC mains power outlet using the mains power cord supplied or as specified in section 9.
- 3) Switch the mains power on at supply outlet first, and then switch the unit on using the power switch located at the rear of the unit.
- 4) Check that the unit is stable and safe by performing a trial sealing operation, as described in section 6.2.

**DANGER**

If the unit has been stored in a cool environment, it must be left to stand unplugged until it has acclimatised to the new room temperature before being powered.

6 Unit Operation



WARNING

Please ensure that you have read and fully understood all of the **Safety Precautions and Limitations of Use** listed in section 2 before attempting to operate the Micro^{TS} unit.

6.1 Status Indicator LEDs

The Micro^{TS} unit operates at a fixed sealing temperature and requires no user set-up or controls. Hence, there are just two status indicator LEDs on the front of the unit with the functions listed in Table 6.

Table 6: Status Indicator LEDs	
	<p>Amber Heater Indicator</p> <p>On or Off – Heater Plate is warming up</p> <p>Flashing – Heater Plate at 170°C ±2°C</p>
	<p>Green Power Indicator</p> <p>On – Unit switched on</p> <p>Off – Unit switched off (or no power)</p>

When the unit is switched on, the green **Power** LED will illuminate and the unit will automatically start heating to 170°C. This is indicated by the amber **Heater** LED being on.

Once the heater plate has reached the correct temperature to perform sealing (within 2°C of the 170°C set-point) the **Heater** LED will start flashing, and the Micro^{TS} is ready for use.

6.2 Performing a Sealing Operation

Various types of plastic sample plates may be loaded onto a plate carrier and thermal sealed using a suitable foil or clear film. See section 4 for details.

A typical operating sequence is:

- 1) Switch the Micro^{TS} on at the rear of the unit and allow sufficient time for it to reach temperature (the **Heater** LED will start flashing).
- 2) Using a suitable adaptor plate (listed in Table 3), load the sample plate onto the plate carrier and add the sealing film on top, the correct way up.

	Care should be taken not to touch the surface of the heater plate whilst loading the sample plate.
---	--

- 3) Grasp the handle with one or two hands, as appropriate, and pull the handle forward and down until the heater plate contacts the sample plate.

	Do not to apply more force to the handle than is necessary to keep the heater in contact with the sample.
---	---

- 4) When the required amount of time has passed, return the handle to its upmost.

	Leaving the handle down for too long could damage the sample plate and degrade the seal quality.
---	--

- 5) Remove the sealed plate from the unit and review the seal integrity.

	The sample plate and film/foil may remain hot for several seconds after being removed from the unit.
---	--

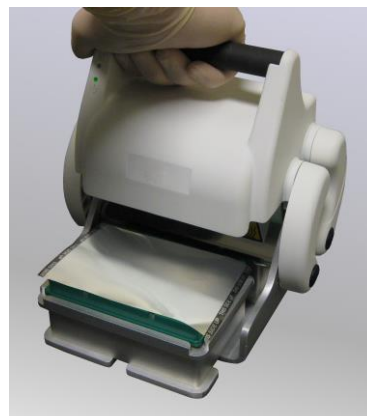
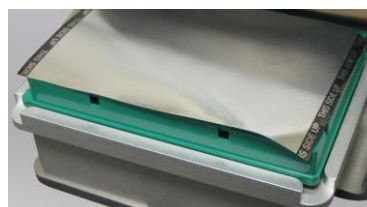
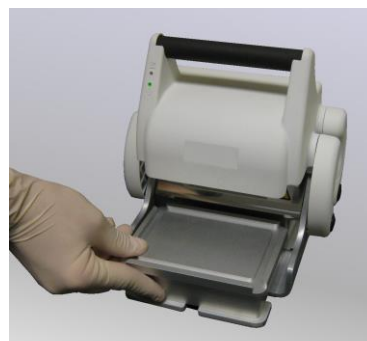

The time taken to successfully seal a sample plate may vary with both plate and film/foil type. For optimum seal integrity, the sealing time may need to be adjusted empirically to achieve the desire seal quality.

7 Maintenance and Servicing

Although the Micro^{TS} unit does not require scheduled maintenance or servicing, the operator should regularly clean and inspect the unit for any detects, as described in section 7.3 below.



DANGER

Please observe and comply with all of the **Unit Maintenance and Serviceability** precautions listed in section 2.



WARNING

Never removed the unit casework. There are no user or operator serviceable parts inside the unit.

Always switch off and unplug the unit before performing any cleaning or disinfecting tasks.

For technical and service related enquiries, please contact your distributor or ITL at the address given on page 2 of this manual.

7.1 Replacing the Unit Fuse

The unit fuse should only be replaced by a suitably qualified technician.



DANGER

The unit fuse will only blow as a result of an internal unit fault or if the voltage selector switch has been incorrectly set (see section 5). This fuse should only be changed after the unit has been thoroughly inspected, and must be replaced with the exact type specified in section 9.

Thoroughly inspect the unit for any signs of damage, loose components or liquid spillage or ingress. If in doubt, please contact ITL on the number given on page 2 of this manual.



DANGER

The fuse holder is removed by disconnecting the mains cord and then using a small flat bladed screwdriver to carefully unclip and pull open the fuse holder (see section 5).

After replacing the fuse with the corrected rated one for the operating voltage being used (see Table 5), push the fuse holder firmly back into the inlet module.

The unit must be electrically safety tested for excess leakage current before being repowered from the mains supply.

7.2 Over Temperature Safety Cut-out

The unit is fitted with a non-resettable thermal fuse which blows if the heater plate temperature exceeds 195 °C.

In the unlikely event of a fault condition, this fuse will permanently disable the heater to protect the user and unit from injury and damage. If this occurs, the Heater indicator will light but heater plate will remain cold and the Micro^{TS} will need to be returned for repair.

7.3 Routine Cleaning and Inspection

The unit casework should be cleaned and inspected at regulator internals, and whenever contamination or spillage occurs, as follows:

1. Switch off the unit and disconnect the power before performing any inspection checks or cleaning.
2. Before cleaning, always inspect the unit casework, heater plate and moving parts for any signs of wear, damage, cracks or other defects.
3. Clean the casework using a damp cloth soaked with a disinfectant solution (such as Virkon), whilst wearing suitable PPE.
4. Carefully clean the heater plate surface to remove any debris or sealing material.
5. Remove any debris or fluff from around or between the moving parts of the handle mechanism.
6. Check and clean the adaptor blocks.



DANGER

After cleaning, ensure that the unit is thoroughly dry, especially around the mains power inlet, before reconnecting the power cord and switching the unit on.

7.4 Decontamination Procedure

The unit and accessories should be decontaminated using the following procedure before being stored or transported.

Certificate of Decontamination

We respect the health and safety of our clients and employees, and request that any products or accessories being returned are decontaminated in accordance with the procedure below.

1. Decontamination Procedure

Thoroughly clean all outside surfaces of the product (including any accessories, power cords, manuals, packaging, etc) with a damp cloth soaked with suitable disinfectant solution (such as Virkon).

Allow to dry fully before packing.

2. Decontamination Declaration

Company Name: _____

Address: _____

Product Code: 958 Micro^{TS}

Serial Number: _____

Reason For Return: _____

Where Product Used: _____

Please tick the appropriate option(s) below:

I certify that I have decontaminated the product as per the above procedure.

Decontaminant Used: _____

I certify that the product has not been exposed to any chemical or biological materials.

Title: _____

Name: _____

Signature: _____

Date: _____

Telephone: _____

Email: _____

7.5 Transportation and Storage

The Micro^{TS} unit and its accessories should be thoroughly decontaminated using the procedure detailed in section 7.4 before being placed in its original packaging for transportation or storage.



WARNING

Refer to section 9 for the acceptable range of Storage and Transportation environmental conditions.

Always ensure that the unit and accessories are completely dry and free of any condensation before being packed.

7.6 Product Disposal

At end-of-life, this product must be disposed of in accordance with your local authority regulations for the disposal of potentially hazardous waste and electronic equipment.

The unit and its accessories should be decontaminated using the procedure detailed in section 7.4 before disposal or shipping.



Do not dispose of this product into unsorted municipal waste or public landfill.

Please contact your distributor (or ITL at the address on page 2 of this manual) for details of how to correctly dispose of this product.

8 Warranty and Returns

Integrated Technologies Limited (ITL) warrants the Micro^{TS} product, when purchased new and installed and operated in accordance with the instructions of this manual, to be free from defects in materials and workmanship, and will repair or replace, at their discretion, any unit or accessory which exhibits such defects.

In no event will ITL be liable for any indirect, incidental or consequential damages resulting from any defect or warranty claim.

**NOTE**

Unspecified use or unauthorised modification of any part of the Micro^{TS} unit or its accessories or the use or attachment of any adaptor or peripheral not supplied, specified or sanctioned by ITL will invalidate this warranty.

This warranty is provided to the original purchaser of the product for one year from the date of purchase.

Under the terms of this warranty, the product must be returned in its original packaging, transportation prepaid by the sender, with a copy of the Proof of Purchase and a detailed description of the problem.

**WARNING**

The product must be decontaminated using the procedure detailed in section 7.4 and a Certificate of Decontamination supplied with any return. If the product is considered too hazardous to be shipped, please contact ITL on the number given on page 2 of this manual for further instructions.

Please contact your distributor (or ITL on the number given on page 2 of this manual) to receive authorisation to return the product.

9 Technical Specification

Model Type

Model Name	Micro ^{TS} (Micro Temperature Sealer)
Modal No	958

Physical Unit Properties

Dimensions (W x D x H)	220 mm x 250 mm x 230 mm
Weight (without adaptor)	4 kg

Mains Supply

Power Cord Rating	IEC C13, 3-Core, 5A min
Inlet Module Type	IEC C14, DPST, Single Fuse
Supply Voltage Selections	<input type="checkbox"/> 115 110 to 120 VAC ±10%
	<input type="checkbox"/> 230 220 to 230 VAC ±10%
Supply Frequency Range	50 to 60 Hz ±5%
Power Consumption	350 W max
Fuse Ratings and Sizes	<input type="checkbox"/> 115 T3.15AH 250V 20x5mm
	<input type="checkbox"/> 230 T1.6AH 250V 20x5mm

Operating Environment

Temperature Range	+18 to +30 °C
Relative Humidity Range	20% to 80% non-condensing
Maximum Operating Altitude	2200 m above sea-level

Storage and Transportation

Temperature Range	-10 to +50 °C
Relative Humidity Range	20% to 95% non-condensing

Sealing Parameters

Temperature Set-point	170 °C (Non-adjustable)
Temperature Accuracy	±2 °C

10 Glossary of Terms and Abbreviations

ANSI	American National Standards Institute
Deepwell Plate	Plate with an SBS footprint featuring 48, 96 or 384 wells with a larger volume than microplates
DWP	Deepwell plate
EMC	Electro-Magnetic Compatibility
Microtiter Plate	Plate with an SBS footprint featuring 24, 48, 96 or 384 wells
MTP	Microtiter plate
PCR	Polymerase Chain Reaction
PPE	Personal Protective Equipment
SBS	Society for Bio molecular Screening
Semi-skirted PCR Plate	PCR plate with an outer surrounding half edge
Skirted PCR Plate	PCR plate with an outer surrounding edge
Un-skirted PCR Plate	PCR plate without an outer surrounding edge
Well	A single sample cavity in a Microtiter plate, PCR plate or Deepwell plate

Contents

1	Symbols Used in this Instruction Manual.....	3
2	Safety Precautions and Limitations of Use	4
3	Regulatory Limitations of Use	8
4	Unit Description	9
5	Unit Installation	11
6	Unit Operation.....	13
6.1	Status Indicator LEDs	13
6.2	Performing a Sealing Operation	14
7	Maintenance and Servicing.....	15
7.1	Replacing the Unit Fuse	15
7.2	Over Temperature Safety Cut-out	16
7.3	Routine Cleaning and Inspection.....	16
7.4	Decontamination Procedure	17
7.5	Transportation and Storage	18
7.6	Product Disposal.....	18
8	Warranty and Returns.....	19
9	Technical Specification	20
10	Glossary of Terms and Abbreviations.....	21

Tables

Table 1: Advisory Symbol Meanings	3
Table 2: Unit Features	9
Table 3: Plate and Adaptor Types	10
Table 4: Recommended Film and Foil Types.....	10
Table 5: Mains Voltage Selection	11
Table 6: Status Indicator LEDs.....	13

Notes