

# Refrigerators

Pass-Thru



i.Series®  
Horizon Series™

# Pass-Thru Refrigerators

## Pharmacy & Blood Bank

Helmer has provided high-quality laboratory equipment and refrigerated products for over 30 years. Our experience and attention to detail allow us to provide a product that offers superior uniformity, outstanding reliability, and exceptional benefits that bring value every day. In addition, our commitment to service and support ensures satisfaction throughout the life of your product. Whether storing blood products, reagents, vaccines, or medication, a Helmer product offers TrueBlue™ protection.

### Helmer Refrigerators Deliver

#### High-Quality Craftsmanship

- Superior chamber temperature uniformity and quick recovery with heavy-duty, forced-air refrigeration system
- Temperature uniformity of +/- 1°C (Blood Bank)
- Operating temperature range from +2°C to +10°C
- Helps meet USP797 Clean Room Requirements
- Bacteria-resistant powder coated exterior and interior for added security
- Sure-Seal self-closing door with magnetic closure eliminates broken door latches
- Drawer mid-stop catch ensures proper closure to maximize airflow, maintain temperature uniformity, and protect glass doors from slide throughs
- Adjustable LED lighting provides energy-efficient illumination with auto-on feature and ON/OFF switch
- Hospital grade plug enhances electrical safety/serviceability

#### Secure Monitoring for a Safe Storage Environment

- i.C<sup>3</sup>® with 7" (177mm) full-color touchscreen (i.Series®)
- Microprocessor temperature controller with built-in alarm monitor (Horizon Series™)
- Key lock
- Password protected settings (i.Series)
- Chart recorder (Blood Bank)
- Meets AABB, ARC, FDA, EU Blood Directive 2004/33/EC, and Part 4 of the Blood Safety and Quality Regulation 2005 standards for blood storage at 4°C

#### Designed for Convenience and Performance

- Single and double door models 26.5 cf (750 L) and 58 cf (1642 L)
- ADA compliant door handles
- Position flush with a countertop, cabinet, or other equipment with no additional clearance required
- Recessed floor and liquid-tight drawers contain spills for easy clean-up and maintain the integrity of other products stored in the refrigerator
- Rechargeable battery backup (i.C<sup>3</sup>)

### Reduced Humidity Levels Create Dry Storage Environment

Helmer has developed a proprietary approach to refrigeration for Laboratory and Pharmacy Refrigerators resulting in reduced condensation on boxes and other containers.

## i.Series® and Horizon Series™ Lines

Helmer has two distinct refrigerator lines. The i.Series offers many unique features not found on other refrigerator models. The i.C<sup>3</sup>® anchors this top-of-the-line series. It offers constant temperature monitoring and control, multiple information logs, event acknowledgement and downloading via a 7" (177mm) full-color touchscreen. (See page 5 for more information.)

The Horizon Series offers a temperature controller with a built-in alarm. It features an LED digital temperature display, programmable high and low temperature alarms, manual alarm checks, and a programmable operating range.

Both the i.Series and Horizon Series offer high quality construction and attention to detail throughout.



## Pass-Thru Models

- i.Series and Horizon Series lines.
- Capacity of 26.5 cf and 58 cf (750 L and 1642 L)

## Blood Bank Models

- Double door with 12 two-way drawers
- Single door with 6 two-way drawers
- Blood bag capacity from 432 to 864 bags
- Door-mounted, eye-level controls (i.Series)

## Pharmacy Models

- Double door with 6 two-way drawers and 6 shelves
- Single door with 3 two-way drawers and 3 shelves
- Door-mounted, eye-level controls (i.Series)





# Pass-Thru Refrigerators

## Temperature Control and Monitoring

### i.Series®

- i.C<sup>3</sup>®, with 7" (177mm) full-color touchscreen monitor described on page 5
- Two stainless steel monitoring probes in product simulation bottles
- Temperature display in °C or °F

### Horizon Series™

- Digital microprocessor temperature controller with a built-in alarm/monitor factory set to 4°C
- Single, stainless steel monitoring probe in product simulation bottle
- Digital offset adjustment for calibration

### i.Series® and Horizon Series™

- Chart recorder with 4" (102mm), 7-day circular charts (Blood Bank):
  - Inkless, pressure-sensitive chart paper with a range of -5°C to +20°C
  - Battery backup
  - Touch button controls for chart changes and calibration

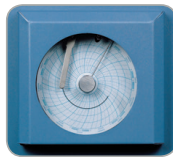

## Cabinet Construction

- Bacteria-resistant powder coated interior, exterior, and door handles
- Covered top for placement in clean room
- Superior engineered frame for maximum rigidity
- Dual-pane glass door(s) with ADA compliant full-length handles
- Innovative self-closing Sure-Seal door system with magnetic seal
- Key lock
- LED lighting with control panel mounted switch
  - Auto ON/OFF (i.Series)
- Minimum of 2" (51mm) non-CFC foamed urethane insulation
- Dual, swivel locking casters
- Access port located in top of cabinet for external monitoring probe(s)
- Integrated evaporation tray in base of unit
- Rechargeable battery is environmentally friendly and long-lasting (i.C<sup>3</sup>)
- Recessed floor for easy clean-up
- Hospital grade plug and cord



## Refrigeration System

- Heavy-duty, air-cooled refrigeration system with non-CFC R-134A refrigerant provides high efficiency and is environmentally friendly
- Forced-air circulation maintains chamber uniformity and provides quick recovery after door openings
- Auto condensate evaporation.
- Evaporator fan(s) shut off during door openings to maintain stable temperatures
- Low humidity levels with reduced condensation (Pharmacy)

## Storage

### Pharmacy Models

- Adjustable, epoxy coated wire shelves
- Side and rear guards prevent items from falling off the shelf

### Pharmacy & Blood Bank Models

- Adjustable, two-way, solid stainless steel pull out drawers
- Sure-Grip coordinated drawer handles with built-in ledge for labels (i.Series)
- Durable, liquid-tight construction for containment of spills
- Stainless steel standards guard against rust and corrosion
- Drawer mid-stop catch ensures proper closure to maximize airflow, maintain temperature uniformity, and protect glass doors from slide throughs
- Easy access to inventory with fully extendable drawer slides
- Scratch-Guard edge protectors keep glass door from being scratched by drawers
- Tube-Guard drawer shields minimize the risk of tube damage in the drawer

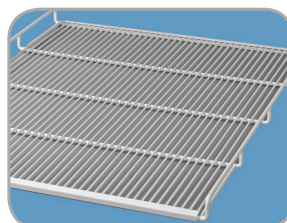
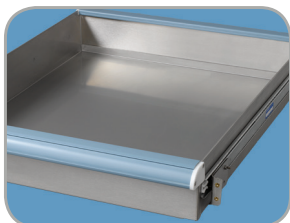

## i.C<sup>3</sup> Monitor · Acknowledge · Download Exclusively on i.Series<sup>®</sup> Models

i.Series refrigerators are monitored with Helmer's exclusive i.C<sup>3</sup> User Interface. The i.C<sup>3</sup> provides constant temperature monitoring and control, and multiple information logs with historical data that can be downloaded and saved.

i.Act™ event acknowledgement allows users to immediately record corrective actions on-screen at the time of the event. Once downloaded, this information will be available to maintain quality control data for auditing purposes.

This icon driven monitoring system features a door mounted 7" (177mm) full-color touchscreen ergonomically placed at eye-level on upright models and angled on undercounter models. The i.C<sup>3</sup> includes sound and visual indicators, and touch navigation. An interactive temperature graph, home screen customization, password protection, and modular design for future options are also included.

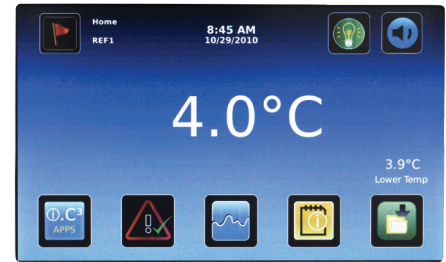

Home

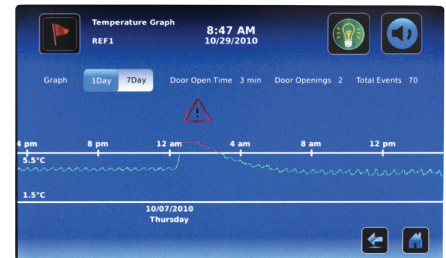

Temperature Graph

## i.Act™ Event Acknowledgement

Enter Event Cause, Action Taken, and Signature directly on-screen and download for audits

HI Temp	Start Date	End Date	Start Time	End Time
	2/6/2010	2/6/2010	6:00A	6:10A

  

	Start Temp	End Temp	Max Temp	Min Temp
Upper Probe	5.2°C	4.0°C	5.8°C	4.8°C
Lower Probe	5.2°C	3.8°C	5.3°C	3.9°C
Compressor Probe	25°C	23°C	27.0°C	26.0°C

**Event Acknowledgement**

Event Cause	Action Taken	Signature
Door Open	Door Closed	Marilyn McElroy 1-7-11 4:36 PM

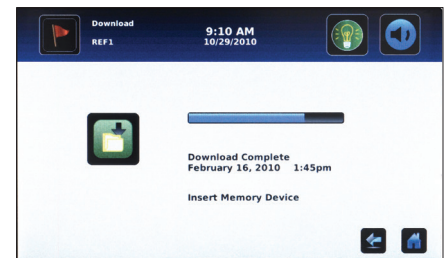

Download

## i.Series<sup>®</sup> / Horizon Series™ Monitoring

### i.Series<sup>®</sup>



### Horizon Series™



#### Exclusive i.C<sup>3</sup> User Interface

- 7" (177mm) full-color, door-mounted touchscreen
- Automatic high/low alarm testing (Peltier based)
- USB ports (2) for download/upload/upgrade
- Optional RS-232 data port
- Dry contact alarm connection
- Password protected settings
- Dual alarm probes
- Digital display of upper and lower chamber temperatures
- Event log displays date, time, and temperature data
- Compressor log displays compressor temperature performance
- Interactive temperature graph
- Digital calibration
- Rechargeable battery backup
- Date and time display
- Alarm mute with adjustable ring-back interval
- Adjustable alarm volume
- Four alarm tones
- High and low temperature alarms
- Door ajar alarm
- Power failure alarm
- Condenser temperature alarm
- RJ45 hub\*

#### Microprocessor-based controller with alarm/monitor

- LED digital display, top bezel mounted
- Manual alarm test
- Dry contact alarm connection
- Single alarm probe
- LED display of chamber temperature
- Digital calibration
- Battery backup
- Alarm mute with 5-minute ring-back interval
- Alarm silence with key switch
- High and low temperature alarms
- Door ajar alarm
- Power failure alarm

\* For special applications

## Specifications

Model/Series	Operating Range	Doors	Volume (cu ft / liter) Bag Capacity*	Interior Dimensions (w x h x d) (in/mm)	Exterior Dimensions (w x h x d) (in/mm)	Shelves	Drawers	Compressor	Electrical	Net Weight
<b>Single Door</b>										
<b>iPR225</b> i.Series	2° to 10°C	2	26.5 / 750	24.75 x 58.25 x 32 629 x 1480 x 813	29.5 x 80 x 36 750 x 2032 x 915	3	3	.33 HP Air-Cooled R134A Non-CFC	115V 60Hz 9.25FLA 230V 50Hz 5.1FLA 230V 60Hz 5.8FLA	534 lb / 243 kg
<b>HPR225</b> Horizon Series	2° to 10°C	2	26.5 / 750	24.75 x 58.25 x 32 629 x 1480 x 813	29.5 x 80 x 36 750 x 2032 x 915	3	3	.33 HP Air-Cooled R134A Non-CFC	115V 60Hz 9.25FLA 230V 50Hz 5.1FLA 230V 60Hz 5.8FLA	523 lb / 238 kg
<b>iB225</b> i.Series	2° to 10°C	2	26.5 / 750 432 bags	24.75 x 58.25 x 32 629 x 1480 x 813	29.5 x 80 x 36 750 x 2032 x 915	0	6	.33 HP Air-Cooled R134A Non-CFC	115V 60Hz 9.25FLA 230V 50Hz 5.1FLA 230V 60Hz 5.8FLA	579 lb / 263 kg
<b>HB225</b> Horizon Series	2° to 10°C	2	26.5 / 750 432 bags	24.75 x 58.25 x 32 629 x 1480 x 813	29.5 x 80 x 36 750 x 2032 x 915	0	6	.33 HP Air-Cooled R134A Non-CFC	115V 60Hz 9.25FLA 230V 50Hz 5.1FLA 230V 60Hz 5.8FLA	568 lb / 258 kg
<b>Double Door</b>										
<b>iPR456</b> i.Series	2° to 10°C	4	58 / 1642	55 x 58.25 x 32 1397 x 1480 x 813	59.25 x 80 x 36 1505 x 2032 x 915	6	6	.5 HP Air-Cooled R134A Non-CFC	115V 60Hz 13.25FLA 230V 50Hz 7.8FLA 230V 60Hz 8.2FLA	797 lb / 362 kg
<b>HPR456</b> Horizon Series	2° to 10°C	4	58 / 1642	55 x 58.25 x 32 1397 x 1480 x 813	59.25 x 80 x 36 1505 x 2032 x 915	6	6	.5 HP Air-Cooled R134A Non-CFC	115V 60Hz 13.25FLA 230V 50Hz 7.8FLA 230V 60Hz 8.2FLA	786 lb / 357 kg
<b>iB456</b> i.Series	2° to 10°C	4	58 / 1642 864 bags	55 x 58.25 x 32 1397 x 1480 x 813	59.25 x 80 x 36 1505 x 2032 x 915	0	12	.5 HP Air-Cooled R134A Non-CFC	115V 60Hz 13.25FLA 230V 50Hz 7.8FLA 230V 60Hz 8.2FLA	852 lb / 387 kg
<b>HB456</b> Horizon Series	2° to 10°C	4	58 / 1642 864 bags	55 x 58.25 x 32 1397 x 1480 x 813	59.25 x 80 x 36 1505 x 2032 x 915	0	12	.5 HP Air-Cooled R134A Non-CFC	115V 60Hz 13.25FLA 230V 50Hz 7.8FLA 230V 60Hz 8.2FLA	841 lb / 382 kg

\* Capacity based on blood bag volume of 450ml · Meets AABB, ARC, and FDA standards for blood storage  
Specifications subject to change · Certified to applicable UL and CSA standards by a NRTL  
Product Data Sheets for all Pharmacy & Blood Bank Pass-Thru Refrigerators are available at [www.helmerinc.com](http://www.helmerinc.com)  
Published interior volumes are nominal; usable cu ft (liters) capacity may be offset by protrusions into cabinet.



## Placement

Pass-Thru refrigerators can be placed between two rooms. The opening should be sized to fit the width of the cabinet. The header above the opening can be built so that it is flush with the top of the cabinet. The refrigerator should be located front to back so that the header resides above the covered portion of the top of the unit. Minimum overhead clearance of 8" (204mm) is required on the open "non-clean room" side of the cabinet.

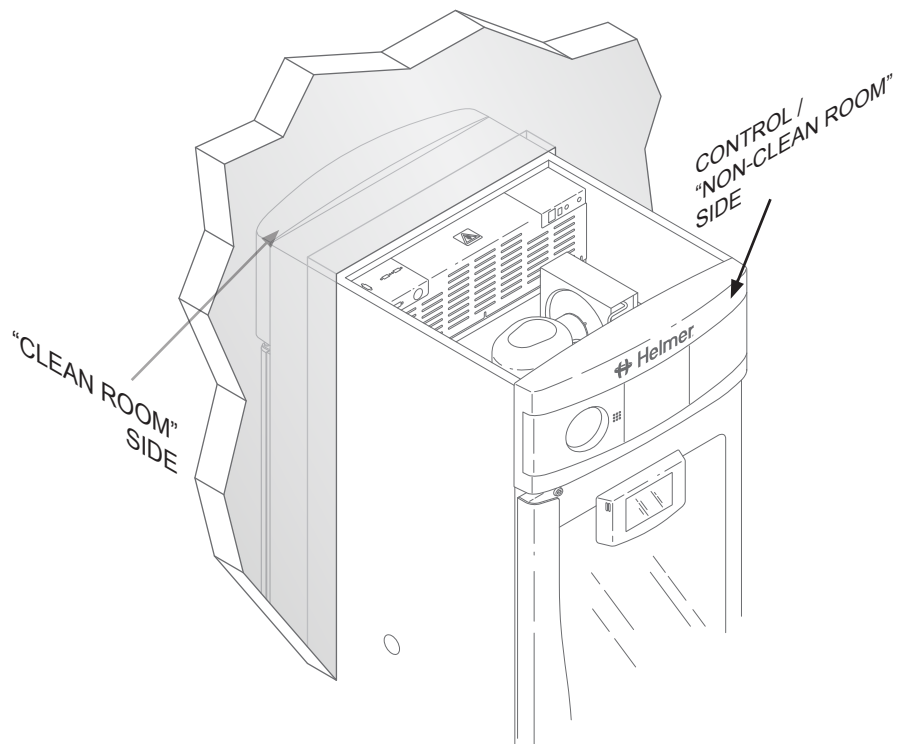
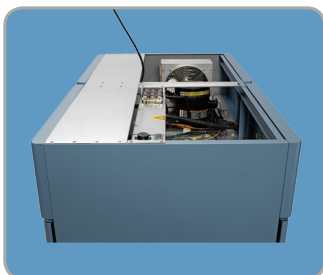

## Custom Storage Options

### Roll Out Baskets

Epoxy coated wire baskets are 4" (102mm) high and adjustable in 1" (26mm) increments. Maximum load 100 lb (46 kg) per basket.



### Solid Stainless Steel Drawer with Hardware

Pull out drawers are 4" (102mm) high and adjustable in 1" (26mm) increments. Maximum load 100 lb (46 kg) per drawer.

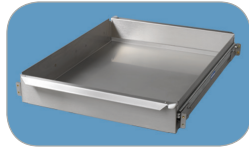

### Full-Size Shelf with Hardware

Epoxy coated wire shelves are adjustable in 1" (26mm) increments. Maximum load 100 lb (46kg) per shelf.

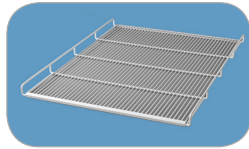

### Half-Size Shelf with Hardware

Epoxy coated wire shelves are adjustable in 1" (26mm) increments. Maximum load 30 lb (14 kg) per shelf. (20-56 cu ft / 572-1586 liters only)



Pass-Thru Refrigerator shown with shelves, roll out baskets, and storage trays

## Cabinet Options



### Custom Access Port

1.75" (45mm). Specify location when ordering.

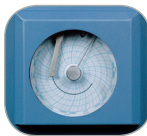

### Temperature Chart Recorder

4" (102mm), 7-day inkless chart recorder. Includes battery backup and a supply of 52 charts. Factory installed

### Left-Hinged Single Door

Factory installed

### Heated Glass Door

Removes fogging and condensation in humid environments

### Solid Door

Ideal for storage of light-sensitive products

### Stainless Steel Interior

Specify when ordering

### Chart Recorder Deduction

Blood Bank Refrigerators may be ordered without chart recorder. Specify when ordering.



## Accessories

### Finish Trim Kit

The Finish Trim Kit provides a perimeter frame around the Pass-Thru Refrigerator.

### Skirt

Mounts to bottom of refrigerator on clean room side, sealing space between refrigerator and floor

### Storage Trays

Simplify and organize your storage needs. Each tray comes with dividers and rails so that individual storage areas can be customized. Great for storage of medication and vaccines.

### Chart Recorder Paper

4" (102mm) diameter, -5°C to +20°C, package of 52

### i.C<sup>3</sup>® Screen Protectors

Package of 3 clear screen protectors for use on i.C<sup>3</sup> User Interface

### USB Flashdrive

Used to download and upload information from/to the i.C<sup>3</sup>

### Remote Alarms (RA1 and RA4)

Extends existing alarms to remote locations within the facility. The RA1 offers monitoring of one device or zone and the RA4 provides monitoring of up to four devices or zones. Operational up to 3000 ft / 915m away (wiring not included).

### Floor Bracket Kit

Secures refrigerator to the building floor. The unit has factory threaded mounting holes. Heavy-gauge, powder coated steel floor mounting brackets and cabinet anchor hardware are provided. Customer to provide floor anchor hardware and onsite assembly.

### Temperature Validation

Package certifies the temperature performance of the refrigerator. This option must be ordered at the time the unit is purchased. Contact Helmer for additional details.

### Certificate of Calibration

Certifies that monitor was calibrated with NIST traceable thermometer before it left Helmer facility.

## Warranty

### i.Series® / Rel.i™ Plus

7 years compressor / 2 years parts / 1 year labor at Helmer

### Horizon Series™ / Rel.i™

5 years compressor / 2 years parts / 1 year labor at Helmer

Warranties applicable in the U.S. and Canada. For international warranty information, contact your local distributor.

