

## Operating Instructions

# Entris

Laboratory Balances

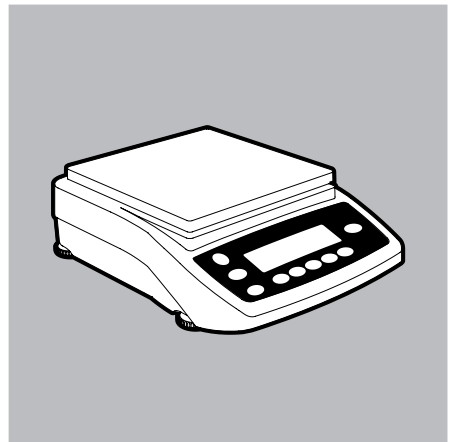
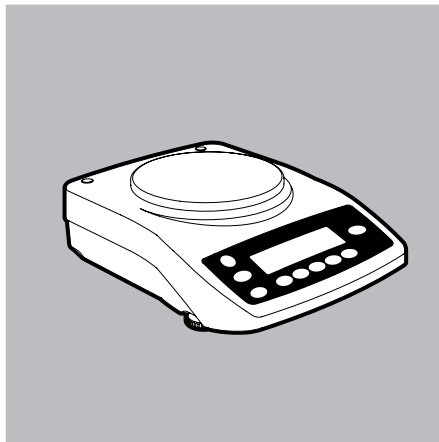
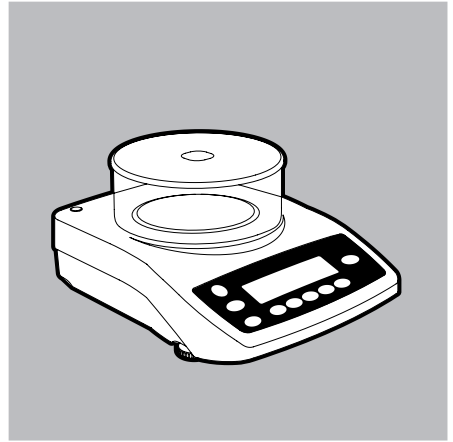
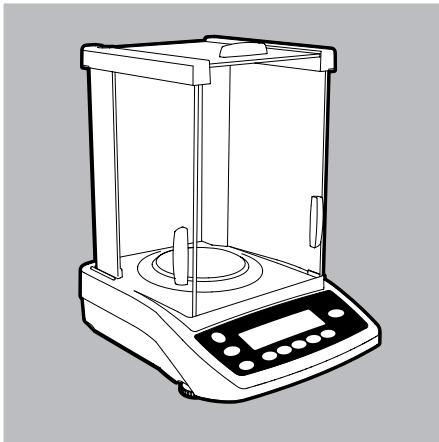

---

# User Information

## Warning | Danger Symbols used in these Instructions:



These notes identify hazards which have a high probability of resulting in death or serious physical injury if not avoided.



These notes identify hazards that can result in moderate or mild injuries if not avoided.



These notes identify hazards associated with the risk of material damage.

---

### Explanation of Symbols

The following symbols are used in these instructions:

- ▶ Indicates a required action
- ▷ Describes what happens after you have performed a particular step

Perform steps in the specified order:

1. First action
  2. Second action
  3. ...
- Indicates an item in a list

Conventions for this User Manual:

- The illustrations in these instructions are based on “Standard” balances.

### Applications Advice | Technical Support

Addresses for applications advice and technical support can be found on the website at:

<http://www.sartorius.com>

---

# Contents

<b>User Information</b> . . . . .	2
Explanation of Symbols. . . . .	2
Applications Advice   Technical Support. . . . .	2
<b>Contents.</b> . . . . .	3
Intended Use. . . . .	3
<b>Safety Instructions.</b> . . . . .	4
<b>Getting Started</b> . . . . .	5
<b>Installation.</b> . . . . .	6
<b>Operation.</b> . . . . .	11
Overview of Display and Control Panel. . . . .	11
Basic Weighing Function. . . . .	12
Calibration and Adjustment. . . . .	13
<b>Configuration (Operating Menu)</b> . . . . .	16
Functions of the Keys during Configuration . . . . .	16
Menu Navigation . . . . .	17
Example: Setting the Language . . . . .	17
Parameter Settings (Overview) . . . . .	18
<b>Application Programs.</b> . . . . .	24
Counting . . . . .	24
Weighing in Percent . . . . .	26
Animal Weighing   Averaging . . . . .	28
Toggling between Weight Units. . . . .	30
Density Determination. . . . .	32
<b>Data Interface</b> . . . . .	35
<b>Status and Error Messages.</b> . . . . .	36
<b>Care and Maintenance.</b> . . . . .	37
<b>Recycling</b> . . . . .	38
<b>Technical Data</b> . . . . .	39
<b>Accessories.</b> . . . . .	44
<b>EC Declaration of Conformity</b> . . . . .	46
<b>FCC Supplier's Declaration of Conformity.</b> . . . . .	47
<b>CSA Certificate of Compliance</b> . . . . .	48

## Intended Use

This high-precision balance is designed to be used exclusively indoors under normal atmospheric conditions.

It was developed specifically for the exact determination of the mass of materials in liquid, paste, powder, or solid form. Appropriate containers must be used for each type of sample material.

# Safety Instructions

## Guidelines and General Information

- The balance complies with EU Directives and standards for electrical safety and electromagnetic compatibility\*. Improper use or handling can, however, result in damage and | or injury.

Any improper use or operation of the balance, i.e., that is not consistent with the instructions, will result in forfeiture of all claims under the manufacturer's warranty.

- Personnel need to have read and understood these installation instructions, including the safety instructions.
- In the event of use in systems and ambient conditions which have greater safety requirements, you must observe the requirements and provisions applicable in your country.
- Always keep the equipment and balance freely accessible.

Any installation work or balance operation that does not conform to the instructions will result in forfeiture of all claims under the manufacturer's warranty.

\* = see "Specifications"



### Danger of Explosion

Do not use this equipment in hazardous areas in which explosive materials are present.



Make sure that the voltage rating printed on the AC adaptor is identical to your local mains voltage.



### Installation Instructions

Do not operate the device if the housing or AC adaptor is damaged. Immediately disconnect the damaged device from the power by pulling the plug.



Do not expose the balance, its power supply or accessories supplied by Sartorius to extreme temperatures, aggressive chemical vapors, moisture, shock, vibrations or strong electromagnetic fields.

Observe the conditions of operation described in the "Technical Data"!



Note on Installation:

The operator shall be solely responsible for any modifications to the equipment and for connecting any cables or equipment not supplied by Sartorius. Information on operational quality is available upon request from Sartorius. Only use original Sartorius accessories!

Note the IP protection class of the balance and its power supply! Do not allow liquid penetration. The protection class specifies the suitability of equipment for various environmental conditions (moisture, foreign bodies).



Before cleaning the AC adapter or the balance: Unplug the power cord.

The balance may only be opened by specialized personnel trained by Sartorius.  
Do not open the AC adaptor.



If glass breaks, there is a risk of injury posed by cuts on glass edges.



Lay the cables where they pose no risk of causing someone to trip.

Observe the additional safety and danger information in the following chapters.

---

# Getting Started

## Storage and Shipping Conditions

- Do not expose the balance to extreme temperatures, moisture, shocks, blows, or vibration.

## Unpacking the Equipment

- ▶ After unpacking the device, check it immediately for any external damage.
- ▷ If you detect any damage, proceed as directed in the “Care and Maintenance” chapter, “Safety Inspection” section.
- ▷ Save all parts of the original packaging for any future transportation. During shipment, please do not leave cables plugged in!

## Equipment Supplied

- Balance
- Weighing pan
- Pan support (only for models with a round weighing pan)
- AC adapter with replaceable, country-specific power plug adapters

Additional equipment on the following models:

- Entris64-1S, Entris124-1S, Entris224-1S, Entris64i-1S, Entris124i-1S, Entris224i-1S
- Sliding panel draft shield
- Shield disk
- Shield plate
- Dust cover

Additional equipment on the following models:

- Entris153-1S, Entris323-1S, Entris423-1S, Entris623-1S, Entris153i-1S, Entris323i-1S, Entris423i-1S, Entris623i-1S
- Round glass draft shield (with shield plate and cover)

## Setup

Choose a location that is not subject to the following negative influences:

- Heat (heater or direct sunlight)
- Drafts from open windows and doors
- Extreme vibrations during weighing
- Extreme humidity

## Conditioning the Balance

Moisture in the air can condense on cold surfaces whenever the equipment is moved to a substantially warmer place. Allow the device to acclimatize for about 2 hours at room temperature, leaving it unplugged from the power supply.

# Installation

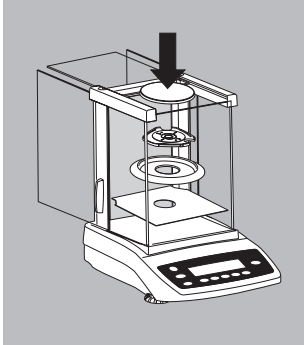

## Setting up the Balance

Balances with Sliding Panel Draft Shield

- ▶ Place the components listed below inside the weighing chamber in the order given:
  - Shield plate
  - Shield disk
  - Pan support
  - Weighing pan

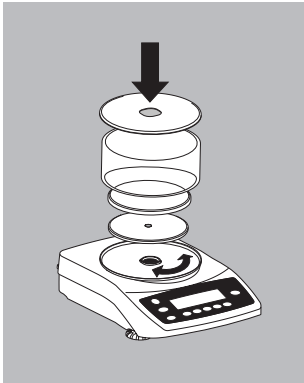

Balances with Round Glass Draft Shield

- ▶ Position the components listed below in the order given:
  - Place lid on top of the balance with the rim facing upwards and rotate until it is securely in place
  - Pan support
  - Weighing pan
  - Glass cover
  - Cover with the rim facing downwards

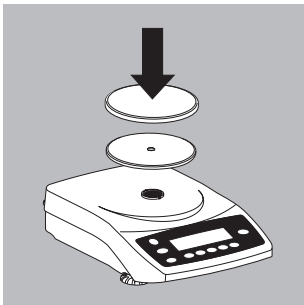

Balances with Round Weighing Pan

- ▶ Position the components listed below in the order given:
  - Pan support
  - Weighing pan

Balances with Rectangular Weighing Pan

- ▶ Place the weighing pan on the balance





## AC Power Supply

### AC Adapter Assembly



**Fatal electric shocks can be caused by use of the incorrect power plug adapter or improper use of the power plug adapter.**

- ▶ Attach the country-specific power plug adapter to the AC adapter. The power plug adapter must be suitable for the wall outlet at the installation location.
- ▶ Do not insert the power plug adapter into the socket without an AC adapter.

Item number on packaging	Power supply/country-specific power plug adapter (packed in PE bag with printed country code, e.g. EU)	Illustration (from left to right)
YEPS01-15V0	Power supply with connection cable	
YEPS01-PS1	USA and Japan (US+JP) Europe (EU) United Kingdom (UK)	
YEPS01-PS2	India (IN) South Africa (ZA) Argentina (AR) Brazil (BR)	
YEPS01-PS3	Australia (AU) Korea (KR) China (CN)	

- ▶ Select the country-specific power plug adapter. The power plug adapter must be suitable for the wall outlet at the installation location.

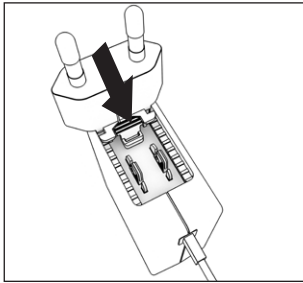

- ▶ Push the power plug adapter into the AC adapter's holder. The ribbed button must be facing forward.
- ▶ Push the power plug adapter all the way in until it audibly engages.
- ▶ Check that the power plug adapter is firmly locked in place. To do this, gently pull on the power plug adapter.
- ▷ If the power plug adapter cannot be moved then it is locked in place.

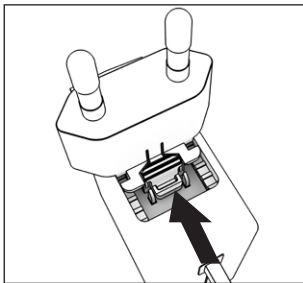

#### Removing the power plug adapter

- ▶ Press on the ribbed button from above and slide the power plug adapter backward.
- ▶ Push the power plug adapter out of the AC adapter and remove it.

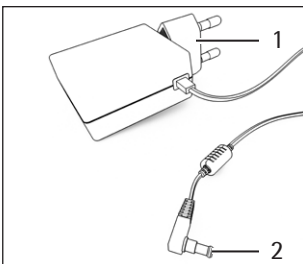

#### Connecting the AC Adapter

- ▶ Check the voltage rating on the AC adapter's type plate. Make sure that the voltage rating printed on this unit matches the local supply voltage at the place of installation.
- ▶ If the stated supply voltage does not comply with the local supply voltage or there is no suitable AC adapter available: Do not use the AC adapter. Contact Sartorius Service.
- ▶ Only use original Sartorius AC adapters.
- ▶ Connect the angle plug (2) to the power supply socket on the back of the device.
- ▶ Connect the power cable (1) to the wall outlet (supply voltage) at the installation location.



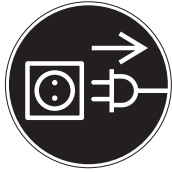

### Connecting Electronic Peripheral Devices

- ▶ Make sure that the balance is unplugged from the power supply before connecting | disconnecting a peripheral device (printer or PC) to or from the interface port.

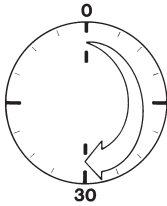

### Warm-up Time

In order to provide accurate results, the instrument must warm up for 30 minutes. Only after this time will the required operating temperature have been reached.

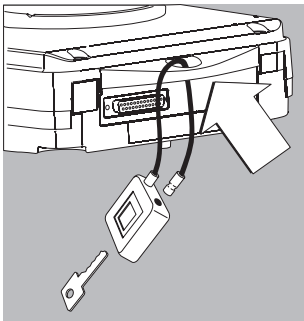

### Anti-theft Locking Device

To fasten an anti-theft locking device, use the lug located on the back of the balance.

- ▶ Secure the balance at the place of location, e.g., with a chain or a lock.

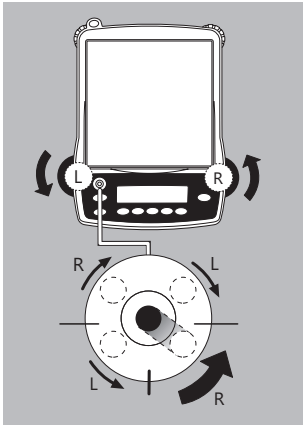

### Levelling the Balance

Purpose:

- To compensate for unevenness at the place of installation

Always level the balance again any time after it has been moved to a different location. Only the 2 front feet are used for leveling.

- ▶ Screw in both rear support feet (only on models with a rectangular weighing pan).
- ▶ Turn the front levelingfeet as shown in the illustration until the air bubble is centered within the circle of the level indicator.
- > Normally, several leveling steps are required.
- ▶ On models with a rectangular weighing pan: Screw out both back leveling feet until they touch the setup surface.

### Underfloor Weighing

A port for a below-cell weighing hook is located on the bottom of the balance.

- ▷ Not permitted for applications in legal metrology.
- ▶ Lift cover plate out of the bottom of the balance. Attention: Place the balance on its side, do not turn over completely!
- ▶ Secure hook 1: Use a wire, for example, to suspend the sample on the hook.
- ▷ Install a draft shield if necessary.

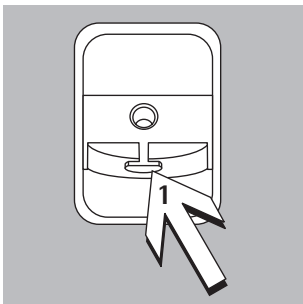
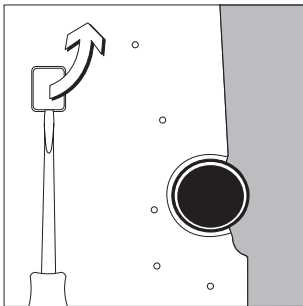

# Operation

## Overview of Display and Control Panel

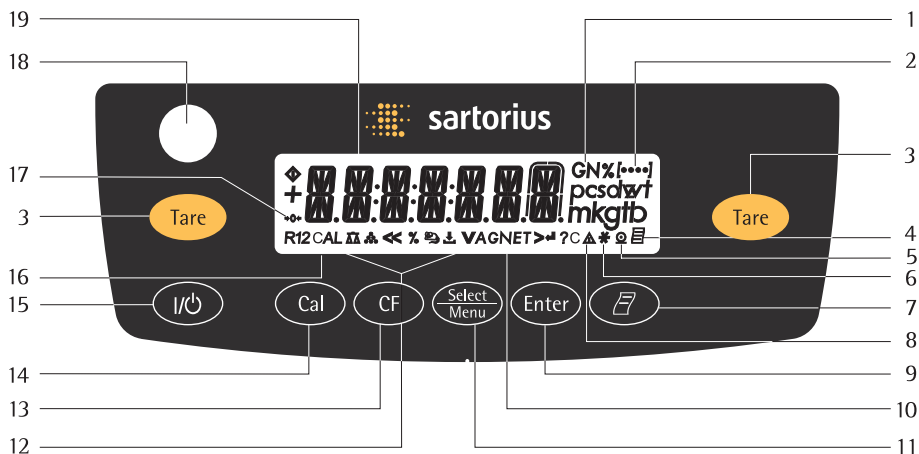



Item	Description	Item	Description
1	Weight units	13	Delete (Clear Function) This key is generally used to cancel functions:
2	Displays the menu level		– Quit application program
3	Taring		– Cancel calibration   adjustment routine   Exit menu
4	Symbol for "GLP printing mode active"	14	Start calibration   adjustment routine
5	Symbol for "Printing mode active"	15	On   Off
6	Application program active	16	Symbol: Calibration   adjustment function
7	Data output: Press this key to send readout values to the built-in data interface.	17	Symbols for "zero range" (verified models only)
8	Calculated-value indicator: not a weight value	18	Level indicator
9	Start the application program	19	Weight value displayed in selected weight unit
10	Symbol: Gross or net		Symbol:
11	Select an application program   open the operating menu	<<	Exit the operating menu
12	Symbols for active application (Application icons)	<	One menu level higher
		V	Scroll through menu items
		>	Next item on current menu level
		↵	Select a parameter setting

# Basic Weighing Function

## Features

- Tare the balance
- Printing weights

## Preparation

- ▶ Switch on the balance:  
Press the  key
- ▶ Tare the balance, if necessary:  
Press the  key

▷ If necessary, change the configuration settings:  
see the chapter entitled “Configuration”





▷ If desired, load the factory settings:  
see the chapter entitled “Configuration”

## Additional Functions:

▷ Switching off the balance:  
Press 

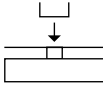
## Example

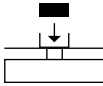
### Simple Weighing

Step	Press key	Display   Printout
1. Switch on the balance Self-test is performed, followed by automatic initial tare function		0.0 g
2. Place container on weighing pan (in this example 11.5 g)		+ 11.5 g
3. Tare the balance		0.0 g
4. Place sample in container (in this example: 132 g)		+ 132.0 g
5. Print weight		N + 132.0 g

---

## Calibration and Adjustment

### Purpose

Calibration is the determination of any difference between the measured value displayed and the true weight (mass) of a sample. Adjustment is the correction of this difference, or its reduction to an allowable level within maximum permissible error limits.

### Features

Calibration | adjustment can be performed only when

- there is no load on the balance
- the balance is tared
- the internal signal is stable
- the weight displayed for the sample on the balance must not differ from the nominal weight by more than 2%.

If these conditions are not met, an error message is displayed "ERR 02".

Following calibration | adjustment, the application program is cleared.

### Internal Calibration | Adjustment

Note:

Only for models with the label **Entris...i-1S** !

In the operating menu, select *CAL.JUST.* - *CAL.INT.* before beginning. The built-in motorized calibration weight located in the housing is applied and removed automatically for internal calibration.

► Select calibration | adjustment:  
Press 

- > The internal calibration weight is applied automatically
- > The balance is adjusted | calibrated
- > The built-in calibration weight is removed

---

## Internal Calibration | Adjustment



Note:

Only for models with the label **Entris.i-1S** !

Set the following parameters:

SETUP - BAL.SCAL. - CAL.JUST. - CAL.INT. (Code 1.1.9.4)

The built-in motorized calibration weight located in the balance housing is applied and removed automatically for internal calibration.



Step	Key (or instruction)	Display
1. Tare the balance		0.0 g
2. Start calibration		CAL.INT.
The internal calibration weight is applied automatically		CAL.RUN.
3. Adjustment carried out		CAL.END
4. The internal weight is defined automatically		0.0 g

## External Calibration

Set the following parameters:

SETUP - BAL.SCAL. - CAL.WUST. - CAL.EXT. (Code 1.1.9.1)



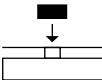
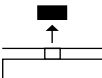



The required calibration weight is configured at the factory (see "Specifications").

Step	Key (or instruction)	Display
1. Tare balance		0.0 g
2. Start adjustment routine		CAL.EXT.  - 5000.0 g
3. Apply the prompted calibration weight (in this example 5000 g). Weight too low: a minus sign "-" is shown Weight too high: a plus sign "+" is shown		5000.0 g
The display stops flashing as soon as the weight value is within the defined limit.		
4. Calibration/adjustment executed; then the calibration weight is displayed		CAL.END + 5000.0 g
5. Remove the calibration weight		0.0 g

# Configuration (Operating Menu)

You can configure the balance; i.e., adapt it to individual requirements.











## Functions of the Keys during Configuration:

Symbol	Key	Function
V		Scroll through menu items
>		One menu level lower (use right cursor to scroll through up to 4 menu levels)
↵		Confirm menu item
	 (Press and hold)	Save settings and exit menu from any position
<<		At the top level: Save settings and exit menu:
<		One menu level higher (left cursor)
[••••]		Indicates menu level



## Menu Navigation

### Example: Setting the Language

Step	Key (or instruction)	Display
1. <b>Open the menu:</b> Open the menu in weighing mode	 hold	APPLIC.
2. Scroll upward within the menu level; After the last menu code, the first code is displayed again	Repeatedly 	INPUT ... LANGUAG.
3. Select the next menu level (scrolls to the right)	Repeatedly 	ENGLISH °
5. <b>Change setting:</b> Scroll until the desired setting is shown		GERMAN
6. <b>Confirm the menu code;</b> "o" indicates the active setting		GERMAN °
7. Return to the next higher menu level		LANGUAG.
▷ Set other menu items as desired	 , 	
8. <b>Save settings</b> and exit menu	Repeatedly: 	
or		
▷ Exit menu without saving changes		
> Restart your application		0.0 g

## Parameter Settings (Overview)







Level 1 [● ]	Level 2 [●● ]	Level 3 [●●● ]	Menu code
SETUP	BAL.SCAL. Balance   scale parameters	AMBIENT conditions	1. 1. 1.
		APP.FILT. Application filter	1. 1. 2.
		STAB.RNG.Stability range	1. 1. 3.
		TARING Taring (1)	1. 1. 5.
		AUT.ZER. Auto zero	1. 1. 6.
		WT.UNIT Basic weight unit	1. 1. 7.
		DISPLAY Display accuracy	1. 1. 8.
		CAL./ADJ. Function of the  key	1. 1. 9.
		CAL.UNIT. weight unit for calibration	1. 1.11.
	INTERF. Interface	BAUDrate	1. 5. 1.
		PARITY Parity	1. 5. 2.
		STOPBIT Number of stop bits	1. 5. 3.
		HANDSHK. Handshake mode	1. 5. 4.
		DATABIT Number of data bits	1. 5. 5.
		DAT.REC. Output: SBI (ASCII) or printout	1. 5. 6.
	PANT.OUT Settings for print function	PRINT (manual   automatic)	1. 6. 1.
		STOPAUT. Stop automatic printing	1. 6. 2.
		AUT.CYCL. Time-dependent autom. printing	1. 6. 3.
		TAR./PRIT. Tare bal./balance after ind. print	1. 6. 4.
		PRT.INIT. Printout of appl. parameters	1. 6. 5.
FORMAT Line format for printout		1. 6. 6.	
EXTRAS (Additional functions)		MENU Menu read only   can edit	1. 8. 1.
	SIGNAL Acoustic signal (beep)	1. 8. 2.	
	KEYS (Keypad)	1. 8. 3.	
	EXT.KEY External switch function	1. 8. 4.	
	ON.MODE Power-on mode	1. 8. 5.	
	BACKLIT Display backlighting	1. 8. 6.	
RESET	MENU Factory settings	1. 9. 1.	
APPLIC.ation programs	WEIGH	2. 1.	
	UNIT Toggle wt. unit	2. 2. 2.	
	COUNT.ing	RESOLUT. Resolution	2. 3. 1.
	PERCENT Weighing in percent	REF.UPDT. Autom. ref. sample updating	2. 3. 2.
		DEC.PLCS Decimal places	2. 4. 1.
	ANIMAL Weighing	ACTIVITY. Animal activity	2. 7. 1.
		START	2. 7. 2.
CALC.ulation	METHOD (Operator)	2. 8. 1.	
	DEC.PLCS Decimal places	2. 8. 2.	
DENSITY determination	DEC.PLCS Decimal places	2. 9. 1.	
INPUT Input	IDNO.	ID input; max. 7 characters, e.g. as Inventory no.	3. 1.
INFORMATION	VERSION, SER.NO., MODEL	Display software ver., serial no., model	4. 1. 2. 3.
LANGUAG. (LANGUAG.)	ENGLISH (factory setting)	5. 1.	
	DEUTSCH (German)	5. 2.	
	FRANÇ.çais (French)	5. 3.	
	ITAL.iano (Italian)	5. 4.	
	ESPAÑOL (Spanish)	5. 5.	
	РУССКИЙ (Russian)	5. 6.	
	POLSKI (Polish)	5. 7.	
	CODES Menu shows codes (not texts)	5. 8.	

## Parameter Settings (Overview)

o = Factory setting; ✓ = User-defined setting



Level 1 [• ]	Level 2 [•• ]	Level 3 [••• ]	Level 4 [•••• ]	Menu code		
SETUP	BAL.SCAL.	AMBIENT conditions (Filter adaptation)	o VERY STABLE	1. 1. 1. 1		
			o STABLE	1. 1. 1. 2		
			o UNSTABL	1. 1. 1. 3		
			o VERY UNSTABLE	1. 1. 1. 4		
		APP.FILT.	Application filter	o FINAL RD	1. 1. 2. 1	
				o FILLING	1. 1. 2. 2	
		STABILITY range	1/4 DIG. (digit)	1. 1. 3. 1		
			1/2 DIG. (digit)	1. 1. 3. 2		
			1 - DIGIT (digit)	1. 1. 3. 3		
			o 2 - DIGIT (digit)	1. 1. 3. 4		
			o 4 - DIGIT (digit)	1. 1. 3. 5		
			o 8 - DIGIT (digit)	1. 1. 3. 6		
		TARING	Taring	o W/O STB (W/o stability)	1. 1. 5. 1	
				o W/ STAB (After stability)	1. 1. 5. 2	
		AUT.ZERO	Auto zero	o OFF	1. 1. 6. 1	
				o ON	1. 1. 6. 2	
		WT.UNIT	Basic weight through unit	For list of units, see Chapter "Toggling between weight units"		1. 1. 7. 1
						1. 1. 7.23
		DISP.DIG.	Display accuracy	o ALL	1. 1. 8. 1	
				o MINUS 1	1. 1. 8. 2	
				o DIVIS. 1 1 interval	1. 1. 8. 6	
CAL./ADJ.	Function of the of the (Cal)	o CAL. EXT. External cal. adj.	1. 1. 9. 1			
		o CAL. INT Internal cal. adj.	1. 1. 9. 2			
		o KEY BLOCKED (Cal) blocked	1. 1. 3. 3			
CAL.UNIT	Unit for calibration weight	o GRAMS	1. 1.11. 1			
		o KILOGR.ams	1. 1.11. 2			
		o POUNDS	1. 1.11. 3			

Level 1 [• ]	Level 2 [•• ]	Level 3 [••• ]	Level 4 [•••• ]	Menu code
SETUP	INTERF. Interface	BAUDrate	600	1. 5. 1. 3
			<input type="radio"/> 1200	1. 5. 1. 4
			<input type="radio"/> 2400	1. 5. 1. 5
			<input type="radio"/> 4800	1. 5. 1. 6
			<input type="radio"/> 9600	1. 5. 1. 7
			<input type="radio"/> 19200	1. 5. 1. 8
		PARITY Parity	<input type="radio"/> ODD	1. 5. 2. 3
			<input type="radio"/> EVEN	1. 5. 2. 4
			<input type="radio"/> NONE	1. 5. 2. 5
		STOPBIT No. of stop bits	<input type="radio"/> 1 STOP BIT	1. 5. 3. 1
			<input type="radio"/> 2 BITS	1. 5. 3. 2
	HANDSHK. Handshake mode	<input type="radio"/> SOFTWARE	1. 5. 4. 1	
		<input type="radio"/> HARDWARE.	1. 5. 4. 2	
		<input type="radio"/> NONE	1. 5. 4. 3	
	DATABIT No. of data bits	<input type="radio"/> 7 BITS	1. 5. 5. 1	
		<input type="radio"/> 8 BITS	1. 5. 5. 2	
	DAT.REC. Com- munication mode	<input type="radio"/> 5 BI (ASCII)	1. 5. 6. 1	
		<input type="radio"/> PRINTER	1. 5. 6. 2	
	PRNT.OUT Printing fct.	PRINT (manual   automatic)	<input type="radio"/> MAN.W/O stability	1. 6. 1. 1
			<input type="radio"/> MAN.WITH. stability	1. 6. 1. 2
			<input type="radio"/> AUT.W/O stability	1. 6. 1. 3
<input type="radio"/> AUT.WITH. stability			1. 6. 1. 4	
STOPAUT. Stop automatic printing		<input type="radio"/> OFF Not possible	1. 6. 2. 1	
		<input type="radio"/> ON Use print key 	1. 6. 2. 2	
AUT.CYCL. Time-dependent autom. printing		<input type="radio"/> EACHVAL (1 display update)	1. 6. 3. 1	
		<input type="radio"/> AFTER 2 (2 display updates)	1. 6. 3. 2	
TAR./PRT. Tare the balance after individual printout		<input type="radio"/> OFF	1. 6. 4. 1	
		<input type="radio"/> ON	1. 6. 4. 2	

Level 1 [• ]	Level 2 [•• ]	Level 3 [••• ]	Level 4 [•••• ]	Menu code	
SETUP	PRNT.OUT Printing fct.	PRT.INIT. Printing applica- tion parameters	OFF	1. 6. 5. 1	
			o ALL parameters	1. 6. 5. 2	
				o MAINPAR.ameters	1. 6. 5. 2
		FORMAT Line for- mat for printout	16.CHAR.(digit not identified)	1. 6. 6. 1	
	o 22.CHAR.acters (w/ ID)		1. 6. 6. 2		
	EXTRAS (Additional functions)	MENU	CANE.DIT.le	1. 8. 1. 1	
			o RD.ONLY read only	1. 8. 1. 2	
		SIGNAL Acoustic signal	OFF	1. 8. 2. 1	
			o ON	1. 8. 2. 2	
		KEYS (keypad)	o FREE	1. 8. 3. 1	
			LOCKED	1. 8. 3. 2	
		EXT.KEY External switch function	o PRINT Key 	1. 8. 4. 1	
			Z I TARE Key 	1. 8. 4. 2	
			CAL. Key 	1. 8. 4. 3	
			SELECT Key 	1. 8. 4. 4	
	CF Key 		1. 8. 4. 5		
		ENTER Key 	1. 8. 4. 6		
	ON-MODE Power-on mode	o OFF/ON Off   on   stand-by	1. 8. 5. 1		
		o STANDBY On   Stand-by	1. 8. 5. 2		
		o AUTO-ON Automatic on mode	1. 8. 5. 3		
BACKLIT Display backlighting	OFF	1. 8. 6. 1			
	o ON	1. 8. 6. 2			
RESET Menu reset	MENU factory settings	YES restore factory settings	1. 9. 1. 1		
		o NO Do not restore factory settings	1. 9. 1. 2		

Level 1 [• ]	Level 2 [•• ]	Level 3 [••• ]	Level 4 [•••• ]	Menu code
APPL. ication programs	WEIGHING toggling between weight UNITS	CONFIG. display accuracy	o ALL	2. 1.
			MINUS 1	2. 2. 2. 1
			DIV. 1 1 interval	2. 2. 2. 2 2. 2. 2. 6
	COUNTING	RESOLUT.	o DISP.DIG. Display accuracy	2. 3. 1. 1
			10 FOLD 10 times > display	2. 3. 1. 2
		REF.UPDT. Auto Reference- updating	o OFF	2. 3. 2. 1
			AUTOM.atic	2. 3. 2. 2
	PERCENT Weighing in percent	DEC.PLCS. Decimal places	NONE no decimal places	2. 4. 1. 1
			o 1 DEC.PL. 1 decimal place	2. 4. 1. 2
			2 DEC.PL. 2 decimal places	2. 4. 1. 3
			3 DEC.PL. 3 decimal places	2. 4. 1. 4
	ANIMALW. Animal weighing	ACTIVITY Animal activity	CALM (fluct.: 2% of test obj.)	2. 7. 1. 1
			o ACTIVE (fluct.: 5% of test obj.)	2. 7. 1. 2
			V.ACTIVE (fluct.: 20% of test obj.)	2. 7. 1. 3
		START	MANUAL	2. 7. 2. 1
o AUTOM.atic			2. 7. 2. 2	
DENSITY determination	DEC.PLCS. decimal places	NONE no decimal places	2. 9. 1. 1	
		o 1 DEC.PL. 1 decimal place	2. 9. 1. 2	
		2 DEC.PL. 2 decimal places	2. 9. 1. 3	
		3 DEC.PL. 3 decimal places	2. 9. 1. 4	

## Device-Specific Information

Level 1 [• ]	Level 2 [•• ]	Level 3 [••• ]	Example	Code
INFO mation	VER.NO.	Show software version	REL.32.09	4. 1.
	SER.NR.	Show serial number, e.g.: (To toggle focus between upper and lower display sections: Press  )	297 12345	4. 2.
	MODEL	Show model designation (to change focus from upper to middle to lower display section and back: Press  )	ENTRIS 124- 15	4. 3.

## Display of Menu Items: Selecting Languages or Codes

LANGUAG. (LANGUAG.)	ENGLISH (factory setting)	5. 1.
	DEUTSCH (German)	5. 2.
	FRANÇ.çais (French)	5. 3.
	ITAL.iano (Italian)	5. 4.
	ESPAÑOL (Spanish)	5. 5.
	PYCCCK (Russian)	5. 6.
	POLSKI (Polish)	5. 7.
	CODES Menu shows codes (not texts)	5. 8.

# Application Programs

## Counting

Display symbol: 

### Purpose

With the Counting application, you can determine the number of parts that each have approximately equal weight. To do this, a known number of parts (the reference sample quantity) is weighed first, and the individual piece weight (reference weight) is calculated from this result. Thus the number of parts subsequently placed on the balance can be determined from their weight.

### Changing the Reference Sample Quantity

Activate function:

Press the  key

Select the desired reference sample quantity (1 to 100):

In increments of 1: Press the  key briefly

In increments of 10:

Press and hold the  key.

The quantity is stored in battery-backed

memory.

### Reference Sample Updating

Automatic reference sample updating optimizes the counting accuracy. You can activate or deactivate this function in the menu.

Automatic reference sample updating is performed when the requirements, including the specified stability criterion, have been met.

The abbreviation *OPT* for “optimizing”, is displayed briefly with the new reference sample quantity.

### Preparation

- ▶ Select the Counting application in the menu:  
see “Configuration”

- ▶ Set the following parameters:

APPLICATION programs

└─ COUNT.

└─ RESOLUTION

└─ 0 *DISP.ACC.* Display accuracy  
└─ 10-FOLD 10-fold higher

└─ REF.UPDT. Autom. ref. sample  
└─ updating

└─ 0 *OFF* Off  
└─ *AUTOM.* Automatic

0 = Factory setting









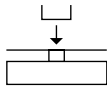

### Printout: Counting

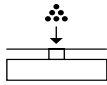
nRef	10	:	Ref. sample quantity
wRef	21.14 g	:	Reference weight for 1 unit
Qnt	+ 500 pcs	:	Calculated quantity

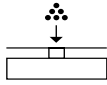

**Example:** Counting parts of equal weight

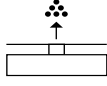
Parameter settings: *APPLIC.* - *COUNT.* (menu code 2. 3.)

Step	Key (or instruction)	Display	Data output
1. Place empty container on the balance		+ 22.6 g	
2. Tare the balance		0.0 g	
3. Add reference sample quantity to container (in this example: 20 pcs)			
4. Changing the reference sample quantity			REF 10 pcs
5. Select reference sample quantity: In increments of 1 (1, 2, 3, ..., 100) In increments of 10 (10, 20, ..., 100)	Repeatedly: Press briefly press and hold	 	REF 20 pcs
6. Confirm selected reference sample quantity and start the application. The current reference weight remains saved until a new reference is set or the power supply is interrupted		+ 20 pcs nRef wRef	* 20 pcs 1.07 g
7. Add desired number of pieces		+ 500 pcs	
8. If desired, print quantity		Qnt +	500 pcs
9. Toggle display between mean piece weight, weight, quantity	Repeatedly: 	+ 1.07 g + 535.0 g + 500 pcs	Δ* * *
10. Unload the balance		- 2 pcs	*
11. Repeat as needed, starting from Step 7			
12. End "Counting"		0.0 g	

# Weighing in Percent

Display symbol: %

## Purpose

This application allows you to obtain weight readouts in percent which are in proportion to a reference weight.

## Changing the Reference Percentage

Activate function:

Press the  key

Select the desired reference (1 to 100):

In increments of 1: Press the  key briefly

Increments of 10: Press and hold the  key.

The percentage is stored in battery-backed memory.

## Preparation

► Select the Weighing in percent application in the menu:  
see “Configuration”

► Set the following parameters:

APPL IC.ation programs

└ PERCENT Weighing in percent

└ DEC.PLACES Decimal places

└ NONE Decimal places

└ 0 DEC.PL. 1 decimal place

└ 2 DEC.PL. 2 decimal places

└ 3 DEC.PL. 3 decimal places

o = Factory setting









## Printout: Weighing in percent

pRef	100	: Reference percentage
Wxx%	111.6 g	: Reference weight for selected reference percentage xx%
Prc	+ 94.9 %	: Calculated reference percentage

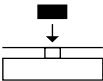
**Example:** Determining residual weight in percent

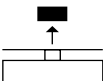
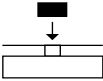
Parameter settings: *APPLIC. - PERCENT* (menu code 2. 4.)

Reference percentage: *REF 100%*

Step	Key (or instruction)	Display   Data output
1. Tare the balance		0.0 g
2. Changing the reference: (see the previous page)		REF 100 %
3. Place sample equal to 100% on the balance (in this example: 111.6 g)		
4. Start the application. The current reference weight remains stored until a new reference is set or power to the power supply is interrupted		+ 100.0 % * pRef 100 % Wxx% + 111.6 g
5. Remove sample (e.g. for drying)		
6. Place weight on the balance (in this example 322.5 g)		+ 94.9 % *
7. If desired, print percentage		Prc + 94.9 %
8. Toggle display between weight and percentage	Repeatedly: 	+ 105.9 g * + 94.9 % *
9. Clear display of residual weight and reference percentage Exit application		+ 105.9 g
10. If desired, print net residual weight		N + 105.9 g

# Animal Weighing | Averaging

Display symbol: 

## Purpose

This application is used to determine the weights of unstable samples (e.g., live animals) or to determine weights under very unstable ambient conditions. With this program, the balance calculates the weight as the average of a defined number of individual weighing operations (also referred to as “subweighing operations”).

## Changing the Number of Subweighing Operations

Activate function:

Press the  key

Select the desired number of measurements (1 to 100):

In increments of 1: Press the  key briefly

Increments of 10: Press and hold the  key.

The selected number of measurements is stored in battery-backed memory.

## Preparation

► Select the Animal weighing application in the menu:  
see “Configuration”

► Set the following parameters:

APPLI.cation programs

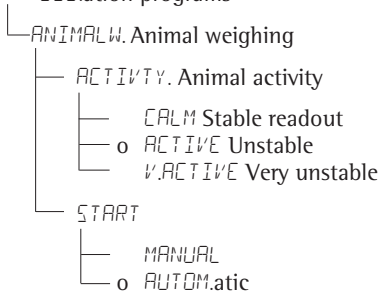







o = Factory setting

## Printout: Animal weighing

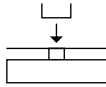
mDef	20	: Number of subweighing operations
x-Net +	410.1 g	: Calculated average

**Example:** Determining animal weight with automatic start and 20 subweighing operations (measurements)

Parameter settings: *APPLIC. - ANIMALW.* (menu code 2. 7.)

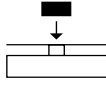
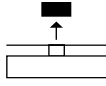
Step	Key (or instruction)	Display   Data output
1. Place animal weighing bowl on the balance		22.6 g
2. Tare the balance		0.0 g
3. Change the number of subweighing operations:		REF 30
4. Select number of measurements: In increments of 1 (1, 2, 3, ..., 100) In increments of 10 (10, 20, ..., 100)	Repeatedly: Press briefly  press and hold 	REF 20
5. Confirm number of measurements and start automatic animal weighing. The number of measurements remains stored in battery-backed memory until the setting is changed		+ 0.0 g *
6. Place first animal in bowl. The balance delays the start of measurements until the difference between 2 measurements meets the criterion		888 19 20 ... 1
7. Read off the result. The result is displayed with the "*" symbol (= calculated value) and remains displayed until the sample (animal) is removed from the load plate (bowl)		+ 410.1 g Δ* mDef 20 x-Net + 410.1 g
8. Unload the balance		+ 0.0 g *
9. Weigh next animal (if des.)		

Next weighing series begins automatically

## toggling between Weight Units

### Purpose











With this application program you can change the weight value displayed from the basic weight unit to any of 4 application weight units (see table on next page).

### Features

- Set the basic unit and display accuracy in the Setup menu: see "Configuration".
- Set the application weight units and display accuracies in the Application menu.
- These settings are stored in battery-backed memory.
- The basic unit is active when the balance is powered up.

**Example:** Change display from the basic unit (in this example, grams [g]) to pounds [lb] and Troy ounces [ozt].

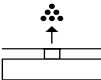
Set the following parameters: *APPLIC. - UNIT* (code 2. 2.)

Step	Press key	Display   Printout
<b>Preparation:</b>		
1. Begin selection of an application weight unit		NONE ° [• ]
2. Select an application weight unit, in this example "pounds" (see table on next page)	Repeatedly: 	POUNDS
3. Confirm the weight unit (pounds)		POUNDS °
4. Select the next application weight unit, in this example: Troy ounces (see table on next page)	 , Repeatedly: 	NONE ° [•• ] TROY.OZ.
5. Confirm weight unit (Troy ounces)		TROY.OZ. °
6. Select other application units if desired (max. 4 total) (otherwise, confirm "NO" by pressing  )		[••• ]
7. Store selection		0.00 g
<b>Conversion:</b>		
8. Place sample on balance		+ 100.00 g
9. Toggle unit for weight value	Repeatedly: 	+ 0.22046 lb + 3.5275 ozt

Depending on the country-specific model version, not all weight units listed may be available.

Menu item	Unit	Conversion factor	Display symbol
1) <i>USERDEF.</i>	Grams	1.00000000000	o
2) <i>GRAMS</i> (Factory setting)	Grams	1.00000000000	g
3) <i>KILOGR.</i>	Kilograms	0.00100000000	kg
4) <i>CARRATS</i>	Carats	5,00000000000	o
5) <i>POUNDS</i>	Pounds	0.00220462260	lb
6) <i>OUNCES</i>	Ounces	0.03527396200	oz
7) <i>TROY.OZ.</i>	Troy ounces	0.03215074700	ozt
8) <i>HKTAEI</i>	Hong Kong taels	0.02671725000	tl
9) <i>SING.TAEI.</i>	Singapore taels	0.02645544638	tl
10) <i>TWN.TAEI.</i>	Taiwanese taels	0.02666666000	tl
11) <i>GRAINS</i>	Grains	15.4323583500	GN
12) <i>PENY.WT.</i>	Pennyweights	0.64301493100	dwt
13) <i>MILLIGR.</i>	Milligrams	1000.000000000	mg
14) <i>PT.P.LB.</i>	Parts per pound	1.12876677120	o
15) <i>CHINA.TAEI</i>	Chinese taels	0.02645547175	tl
16) <i>MOMMES</i>	Mommes	0.26670000000	m
17) <i>AUST.CT.</i>	Austrian carats	5.00000000000	Kt
18) <i>TOLA</i>	Tola	0.08573333810	o
19) <i>BAHT</i>	Baht	0.06578947436	b
20) <i>MESGHAL</i>	Mesghal	0.21700000000	o
21) <i>TONS</i>	Tons	0.0000100000	t
22) <i>LB / OZ 1)</i>	Pounds : ounces	0.03527396200	lb oz
23) <i>NEWTON</i>	Newton	0.00980665000	N

1) = The format for display of pounds: ounces is xx:yy.yyy; x=lb, y=oz

---

# Density Determination

Display symbol:  $\bar{\Delta}\bar{\Delta}$

## Purpose

This application program lets you determine the density of solid substances using the buoyancy method.

## Features

To enter the density of the buoyancy liquid(g/cm<sup>3</sup>) at the corresponding temperature, press . See the next page for a table of density values for water. The factory setting is 1 g/cm<sup>3</sup>.

The following formula is applied:

Density of sample =

$$\frac{\text{Weight in air}}{\text{(Weight in air - weight in water)}} + \text{density of liquid}$$

When you start the density determination routine, the density of the liquid is displayed briefly.

Positive and negative values can be stored for weight in air and weight in water.

The weight in water must be less than the weight in air; otherwise, an error message is displayed.

The results can be displayed with 0 to 3 decimal places: see "Configuration". Not part of the scope of delivery: sample holder and suspension wire.

## Preparation

- ▶ Select the Density Determination application in the menu: see "Configuration"
- ▶ Set the following parameters:

APPLIC. ation programs

DENSITY determination

DEC.PLCS Decimal places

NONE No decimal places

o 1 DEC.PL. 1 decimal place

2 DEC.PL. 2 decimal places

3 DEC.PL. 3 decimal places

o = Factory setting

Note on using 3 decimal places:  
Using three decimal places for density can result in a high measurement error rate because corrections to the air density and the density calculation sets are not taken into account, for example.



### Printout for Density Determination

RhoFL	0.99823	o	: Density of liquid (g/cm <sup>3</sup> )
Wa	+	20.0	g : Weight in air
WfL	+	15.0	g : Weight in liquid
Rho		4.0	o : Result: density of the sample

**Table:**  
Density of H<sub>2</sub>O at Temperature T (in °C)













T/°C	0.0	0.1	0.2	0.3	0.4	0.5	0.6	0.7	0.8	0.9
10.	0.99973	0.99972	0.99971	0.99970	0.99969	0.99968	0.99967	0.99966	0.99965	0.99964
11.	0.99963	0.99962	0.99961	0.99960	0.99959	0.99958	0.99957	0.99956	0.99955	0.99954
12.	0.99953	0.99951	0.99950	0.99949	0.99948	0.99947	0.99946	0.99944	0.99943	0.99942
13.	0.99941	0.99939	0.99938	0.99937	0.99935	0.99934	0.99933	0.99931	0.99930	0.99929
14.	0.99927	0.99926	0.99924	0.99923	0.99922	0.99920	0.99919	0.99917	0.99916	0.99914
15.	0.99913	0.99911	0.99910	0.99908	0.99907	0.99905	0.99904	0.99902	0.99900	0.99899
16.	0.99897	0.99896	0.99894	0.99892	0.99891	0.99889	0.99887	0.99885	0.99884	0.99882
17.	0.99880	0.99879	0.99877	0.99875	0.99873	0.99871	0.99870	0.99868	0.99866	0.99864
18.	0.99862	0.99860	0.99859	0.99857	0.99855	0.99853	0.99851	0.99849	0.99847	0.99845
19.	0.99843	0.99841	0.99839	0.99837	0.99835	0.99833	0.99831	0.99829	0.99827	0.99825
20.	0.99823	0.99821	0.99819	0.99817	0.99815	0.99813	0.99811	0.99808	0.99806	0.99804
21.	0.99802	0.99800	0.99798	0.99795	0.99793	0.99791	0.99789	0.99786	0.99784	0.99782
22.	0.99780	0.99777	0.99775	0.99773	0.99771	0.99768	0.99766	0.99764	0.99761	0.99759
23.	0.99756	0.99754	0.99752	0.99749	0.99747	0.99744	0.99742	0.99740	0.99737	0.99735
24.	0.99732	0.99730	0.99727	0.99725	0.99722	0.99720	0.99717	0.99715	0.99712	0.99710
25.	0.99707	0.99704	0.99702	0.99699	0.99697	0.99694	0.99691	0.99689	0.99686	0.99684
26.	0.99681	0.99678	0.99676	0.99673	0.99670	0.99668	0.99665	0.99662	0.99659	0.99657
27.	0.99654	0.99651	0.99648	0.99646	0.99643	0.99640	0.99637	0.99634	0.99632	0.99629
28.	0.99626	0.99623	0.99620	0.99617	0.99614	0.99612	0.99609	0.99606	0.99603	0.99600
29.	0.99597	0.99594	0.99591	0.99588	0.99585	0.99582	0.99579	0.99576	0.99573	0.99570
30.	0.99567	0.99564	0.99561	0.99558	0.99555	0.99552	0.99549	0.99546	0.99543	0.99540

Parameter settings:

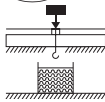
APPLIC. - DENSITY - DEC.PLCS. - 1 DEC.PL. (menu code 2. 9. 1. 2)

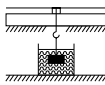
**Example:** Determining the density of a solid using water as the buoyancy liquid.

The density of water at 20°C is 0.99823 g/cm<sup>3</sup>.

Step	Key (or instruction)	Display   Data output
1. Attach sample holder and suspension wire		
2. Tare the balance		0.0 g
3. Edit the stored density value		_ 1.00000
4. Enter the density of the liquid (in this example: 0.99823)	Repeatedly:  , briefly or press and hold ;  , etc.	_ 0.99823
5. Save density value and start application. The density value is stored in battery-backed memory until the setting is changed		
6. Confirm "AIR" display		AIR ?
7. Determine the weight of sample in the air: Place sample on the balance		+ 20.0 g ?*
8. Store value for weight in air		
9. Remove sample from the balance		WATER ?
10. Determine weight in liquid: Place sample in holder		
11. Confirm "WATER" display		0.0 g ?*
12. Immerse sample in liquid		+ 15.0 g ?*
13. Store value for weight in liquid, view and print result		+ 4.0 <sup>0</sup> ?*
		RhoFL 0.6237 o
		Wa + 20.0 g
		WfL + 15.0 g
14. Delete result		Rho 4.0 o
15. Repeat as needed, starting from Step 5		

# Data Interface

## Purpose

Your balance comes equipped with an interface port for connection to a computer or other peripheral device. You can use an on-line computer to change, start and/or monitor the functions of the balance and the application programs.

## Female interface connector

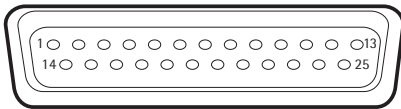

Pin Assignment Chart, 25-pin, RS-232:

- Pin 1: Shield
- Pin 2: Data output (TxD)
- Pin 3: Data input (RxD)
- Pin 4: Internal ground (GND)
- Pin 5: Clear to Send (CTS)
- Pin 6: Not connected
- Pin 7: Internal ground (GND)
- Pin 8: Internal ground (GND)
- Pin 9: Not connected
- Pin 10: Not assigned
- Pin 11: + 12 V (operating voltage for Sartorius printer)
- Pin 12: Reset \_ Out
- Pin 13: + 5 V
- Pin 14: Internal ground (GND)
- Pin 15: Universal remote switch
- Pin 16: Not connected
- Pin 17: Not connected
- Pin 18: Not connected
- Pin 19: Not connected
- Pin 20: Data Terminal Ready (DTR)
- Pin 21: Not connected
- Pin 22: Not connected
- Pin 23: Not connected
- Pin 24: Not connected
- Pin 25: + 5 V

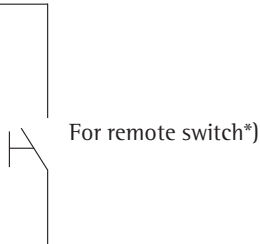

## Preparation

You can set these parameters for other devices in the Setup menu: see “Configuration”.

You will also find a detailed description

of the available data interface commands in the file “Data Interface Descriptions for Entris Models”, which you can download from the Sartorius website:

([www.sartorius.com](http://www.sartorius.com)  
”Download Center”).

\*) = Hardware restart

# Status and Error Messages

Error codes are shown on the main display for approx. 2 seconds. The program then returns automatically to the previous mode.

Display	Cause	Solution
No segments appear on the display	No AC power is available The power supply is not plugged in	Check the AC power supply Plug in the power supply
HIGH	The load exceeds the balance capacity	Unload the balance
LOW or ERR 54	Something is touching the weighing pan	Move the object that is touching the weighing pan
APP.ERR.	Cannot store data: Load on weighing pan too light or no sample on pan while application is active	Increase load
DIS.ERR.	Display error: Data output not compatible with output format	Change the configuration in the operating menu
PRT.ERR.	Interface port for printer output is blocked	Reset the menu factory settings or Contact your local Sartorius Service Center
ERR 02	Calibration parameter not met, e.g.: – Press <b>Tare</b> to tare the balance – load on weighing pan	Calibrate only when zero is displayed  Unload the balance
ERR 10	The <b>Tare</b> key is blocked for active application programs; Only 1 tare function can be used at a time	After the tare memory has been deleted using the <b>CF</b> key, the <b>Tare</b> key can be used again
ERR 11	Tara memory not allowed	Press <b>Tare</b>
The weight readout changes constantly	Unstable ambient conditions (excessive vibration or draft) A foreign object is caught between weighing pan and housing	Set up balance in another area Adjust Setup configuration Remove the foreign object
The weight readout is obviously wrong	The balance was not calibrated/adjusted Balance not tared before weighing	Calibrated   adjust the balance

If any other errors occur, contact your local Sartorius Service Center.

Contact information: <http://www.sartorius.com>

---

# Care and Maintenance

## Service

On request, Sartorius can offer you an individual service contract.

## Repairs

Repair work must only be carried out by trained service technicians. Repairs performed by untrained persons may result in considerable hazards for the user.

## Cleaning



Unplug the AC adapter from the wall outlet (mains supply). If you have an interface cable connected to the balance port, unplug it from the port. Make sure that no liquid enters the balance housing.

- ▶ Clean the balance with a cloth lightly moistened with soap solution.
- ▷ The plastic top and bottom parts of the balance housing have a special coating that allows acetone to be used to clean these parts.



Do not clean the following parts with acetone or aggressive cleaning agents: foil-covered keypad, power connector port, data interface, or any other plastic parts.

- ▶ Wipe the balance with a soft, dry cloth.

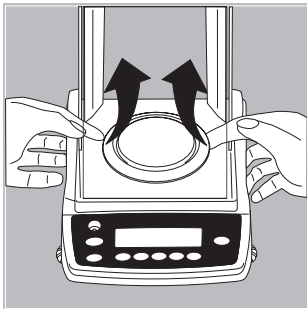

On analytical balances remove and clean the weighing pan as follows:



Reach beneath the shield disk and lift it up carefully together with the weighing pan to avoid damaging the weighing system. Make sure that no liquid enters the balance housing.

---

### Cleaning Stainless Steel Surfaces

Clean all stainless steel parts regularly. Remove the stainless steel weighing pan and thoroughly clean it separately. Use a damp cloth or sponge to clean stainless steel parts on the balance.

You can use any household cleaning agent that is suitable for use on stainless steel. Clean stainless steel surfaces only by wiping them down. Then rinse the equipment thoroughly, making sure to remove all residues. Afterwards, allow the equipment to dry. If desired, you can apply oil to the cleaned surfaces as additional protection.

---

# Recycling

## Safety Inspections

If there is any indication that safe operation of the balance is no longer warranted:

- ▶ Disconnect the equipment from the AC power: Unplug the power cord.
- > Lock the balance in a secure place to ensure that it cannot be used for the time being.

## Recycling

The packaging is made of environmentally friendly materials that can be used as secondary raw materials. If you no longer need this packaging, bring it to your local recycling and waste disposal facility according to the regulations applicable in your country. (Contract number D-59101-2009-1129). Otherwise you should dispose of the material in accordance with the waste disposal regulations that are applicable in your area.



The equipment, including accessories and batteries, does not belong in your regular household waste. The EU legislation requires its Member States to collect electrical and electronic equipment and disposed of it separately from other unsorted municipal waste with the aim of recycling it.

For more information regarding disposal and recycling, please contact our local service representatives. Our partners listed on the following website will also be able to provide assistance within the EU:

- 1) Go to <http://www.sartorius.com>.
- 2) Select the “Services” tab.
- 3) Then select “Disposal Information”.
- 4) Addresses for the local Sartorius disposal contacts can be found in the PDF files available for download on this page.



Sartorius will not take back equipment contaminated with hazardous materials (ABC contamination) – either for repair or disposal.

---

## Service address disposal:

Please refer to our website ([www.sartorius.com](http://www.sartorius.com)) or contact the Sartorius Service Center for more detailed information regarding repair service addresses or the disposal of your device.

# Technical Data

## General Specifications

	Unit	Value
Int. weight circuit		
All models with the designation Entris ... i-1S are equipped with an internal calibration weight.		
Power consumption (including AC adapter)		
Maximum	VA	16
Typical	VA	8
Operating time with external battery YRB11Z (display backlighting on), approx.	h	35
Supply voltage		
Only via Sartorius AC adapter YEPS01-15V0 with country-specific power plug adapters (for country-specific power plug adapters see chapter "Installation")		
Electromagnetic Compatibility (EMC) as per EN61326-1:		
Transient emissions: Class B		
Defined immunity to interference: Industrial areas		

## Ambient Conditions

	Unit	Value
Temperature		
Storage and transport	°C	+10 to +40
Operation	°C	+10 to +40

## AC adapter

	Unit	Value
Power supply (primary)		
Voltage	$V_{AC}$	100 – 240 $\pm$ 10 %
Current	A	0.2
Frequency	Hz	50 – 60 $\pm$ 5 %
Power supply (secondary)		
At between 0°C and +40°C	$V_{DC}$   mA (max.)   W (max.)	15 $\pm$ 5 %   530   8
At between +40°C and +50°C	$V_{DC}$   mA (max.)   W (max.)	15 $\pm$ 5 %   330   5
Installation location, above sea level (NN)	m	3000
Protection class according to EN/IEC 60950-1		II
Protection class according to EN/IEC 60529		IP40
Dimensions (L x W x H)	mm	100 x 60 x 50
Weight	g	90,0



## Model-specific Specifications

<b>Modele: Entris</b>		<b>224-1x<sup>1)</sup></b> <b>224i-1x<sup>1)</sup></b>	<b>124-1x<sup>1)</sup></b> <b>124i-1x<sup>1)</sup></b>	<b>64-1x<sup>1)</sup></b> <b>64i-1x<sup>1)</sup></b>
Weighing capacity	g	220	120	60
Readability	g	0.0001	0.0001	0.0001
Tare range (subtractive)	g	220	120	60
Repeatability (standard deviation)	< ± g	0.0001	0.0001	0.0001
Linearity deviation	< ± g	0.0002	0.0002	0.0002
Typical stabilization time	s	2.5	2.5	2.5
Sensitivity drift within +10°C ... +30°C	< ± ppm/K	3	3	3
Adaptation to ambient conditions		By selection of 1 of 4 optimized filter levels; display update: 0.1–0.4 (depends on filter level selected)		
External calibration weight (of at least accuracy class...)	g	200 (E2)	100 (E2)	50 (E2)
Net weight, approx.	kg	4.4   4.8	4.4   4.8	4.4   4.8
Weighing pan size	mm	Ø 90	Ø 90	Ø 90
Weighing chamber height*	mm	230	230	230
Dimensions (W × D × H)	mm	230 × 303 × 330		

<b>Modele: Entris</b>		<b>623-1x<sup>1)</sup></b> <b>623i-1x<sup>1)</sup></b>	<b>423-1x<sup>1)</sup></b> <b>423i-1x<sup>1)</sup></b>	<b>323-1x<sup>1)</sup></b> <b>323i-1x<sup>1)</sup></b>
Weighing capacity	g	620	420	320
Readability	g	0.001	0.001	0.001
Tare range (subtractive)	g	620	420	320
Repeatability (standard deviation)	< ± g	0.001	0.001	0.001
Linearity deviation	< ± g	0.002	0.002	0.002
Typical stabilization time	s	1.0	1.0	1.1
Sensitivity drift within +10°C ... +30°C	< ± ppm/K	3	3	3
Adaptation to ambient conditions		By selection of 1 of 4 optimized filter levels; display update: 0.1–0.4 (depending on the set filter level)		
External calibration weight (of at least accuracy class...)	g	500 (E2)	200 (E2)	200 (E2)
Net weight, approx.	kg	3.2 3.6	3.2 3.6	3.2 3.6
Weighing pan size	mm	Ø 115	Ø 115	Ø 115
Weighing chamber height*	mm	45	45	45
Dimensions (W × D × H)	mm	230 × 303 × 136		

<sup>1)</sup> Possible terms for country-specific models:

x = S: Standard scales without country-specific additions

x = SUs: Standard scales with country-specific additions for USA

\* Upper edge of the weighing pan to the lower edge of the upper draft shield panel

<b>Model: Entris</b>		<b>153-1x<sup>1)</sup></b> <b>153i-1x<sup>1)</sup></b>	<b>822-1x<sup>1)</sup></b> <b>822i-1x<sup>1)</sup></b>
Weighing capacity	g	150	820
Readability	g	0.001	0.01
Tare range (subtractive)	g	150	820
Repeatability (standard deviation)	< ± g	0.001	0.01
Linearity deviation	< ± g	0.002	0.03
Typical stabilization time	s	1.3	1.5
Sensitivity drift within +10°C ... +30°C	< ± ppm/K	3	4
Adaptation to ambient conditions		By selection of 1 of 4 optimized filter levels; display update: 0.1–0.4 (depends on filter level selected)	
External calibration weight (of at least accuracy class...)	g	100 (E2)	500 (F1)
Net weight, approx.	kg	2.6 3.0	2.0 2.6
Weighing pan size	mm	∅ 115	∅ 150
Weighing chamber height*	mm	45	–
Dimensions (W×D×H)	mm	230×303×136	230×303×87

<b>Model: Entris</b>		<b>6202-1x<sup>1)</sup></b> <b>6202i-1x<sup>1)</sup></b>	<b>4202-1x<sup>1)</sup></b> <b>4202i-1x<sup>1)</sup></b>	<b>3202-1x<sup>1)</sup></b> <b>3202i-1x<sup>1)</sup></b>	<b>2202-1x<sup>1)</sup></b> <b>2202i-1x<sup>1)</sup></b>
Weighing capacity	g	6,200	4,200	3,200	2,200
Readability	g	0.01	0.01	0.01	0.01
Tare range (subtractive)	g	6,200	4,200	3,200	2,200
Repeatability (standard deviation)	< ± g	0.01	0.01	0.01	0.01
Linearity deviation	< ± g	0.03	0.03	0.03	0.03
Typical stabilization time	s	1.5	1.5	1.5	1.5
Sensitivity drift within +10°C ... +30°C	< ± ppm/K	4	4	4	4
Adaptation to ambient conditions selected)		By selection of 1 of 4 optimized filter levels; display update: 0.1–0.4 (depends on filter level selected)			
External calibration weight (of at least accuracy class...)	g	5,000 (E2)	2,000 (E2)	2,000 (E2)	2,000 (E2)
Net weight, approx.	kg	3.1 3.5	3.1 3.5	3.1 3.5	3.1 3.5
Weighing pan size	mm	180×180	180×180	180×180	180×180
Dimensions (W×D×H)	mm	230×303×91			

<sup>1)</sup> Possible terms for country-specific models:

x = S: Standard scales without country-specific additions

x = SUS: Standard scales with country-specific additions for USA

\* Upper edge of the weighing pan to the lower edge of the upper draft shield panel

<b>Modele: Entris</b>		<b>8201-1x<sup>1)</sup></b>	<b>5201-1x<sup>1)</sup></b>	<b>2201-1x<sup>1)</sup></b>
		<b>8201i-1x<sup>1)</sup></b>	<b>5201i-1x<sup>1)</sup></b>	<b>2201i-1x<sup>1)</sup></b>
Weighing capacity	g	8,200	5,200	2,200
Readability	g	0.1	0.1	0.1
Tare range (subtractive)	g	8,200	5,200	2,200
Repeatability (standard deviation)	< ± g	0.1	0.1	0.1
Linearity deviation	< ± g	0.3	0.3	0.3
Typical stabilization time	s	1.5	1.5	1.5
Sensitivity drift within +10°C ... +30°C	< ± ppm/K	8	8	8
Adaptation to ambient conditions	By selection of 1 of 4 optimized filter levels; display update: 0.1–0.4 (depends on filter level selected)			
External calibration weight (of at least accuracy class...)	g	5,000 (F1)	5,000 (F1)	2,000 (F2)
Net weight, approx.	kg	2.7 3.5	2.7 3.5	2.7 3.5
Weighing pan size	mm	180 × 180	180 × 180	180 × 180
Dimensions (W × D × H)	mm	230 × 303 × 91		

<sup>1)</sup> Possible terms for country-specific models:

x = S: Standard scales without country-specific additions

x = SUS: Standard scales with country-specific additions for USA

# Accessories

## External calibration weights

For Entris balance models	Accuracy class	Weight in grams	Order No.
224	E2	200	YCW522-AC-02
124	E2	100	YCW512-AC-02
64	E2	50	YCW452-AC-02
623	F1	500	YCW553-AC-02
423	F1	200	YCW523-AC-02
323	F1	200	YCW523-AC-02
153	F1	100	YCW513-AC-02
6202	F1	5000	YCW653-AC-02
4202	F1	2000	YCW623-AC-02
3202	F1	2000	YCW623-AC-02
2202	F1	2000	YCW623-AC-02
822	F2	500	YCW554-AC-02
8201	F2	5000	YCW654-AC-02
5201	F2	5000	YCW654-AC-02
2201	F2	2000	YCW624-AC-02

Item	Order No.
Data printer for reports with date, time, statistics evaluation, item counter functions and LCD display	YDP20-OCE
Additional display, reflective (for connection to data interface port)	YRD03Z
External rechargeable battery pack	YRB11Z
<p>With battery-level indicator (LED); can be recharged using the balance's AC adapter (charge time for completely discharged battery pack: 15 hours); see section "Technical Data" for operating time. To recharge the battery pack: Unplug the AC adapter from the balance and plug it into the battery pack</p>	
Density determination kit, for Entris 224, Entris 124, Entris 64	YDK03
Data cable	
RS232 25-pin (m)   USB type A, length approx. 1.8 m	YCC01-USBM2
RS232 25-pin (m)   25-pin (f), length approx. 1.5 m	7357312
RS232 25-pin (m)   9-pin (f), length approx. 2.0 m	7357314
RS232 25-pin (m)   9-pin (f), length approx. 0.5 m	6965619

<b>Item</b>	<b>Order No.</b>
Ionizing blower for eliminating static electricity	
220 V	YIB01-ODR
120 V	YIB01-OUR
Stat-pen, anti-static device for neutralizing static charges and samples (100 V to 230 V, 50/60 Hz)	YSTP01
Weighing table	
made from wood with natural stone	YWT09
made from natural stone, with vibration dampening	YWT03
Wall console	YWT04
Protective cover	
for models with rectangular weighing pan	6960ED01
for models with round weighing pan (Ø 150 mm)	6960ED02
Dust cover for models with sliding door draft shields	6960BP08
Weighing pan	
1000 ml, weight ~240 g, Ø 186 mm, h= 77 mm, stainless steel	641211
500 ml, weight ~113 g, Ø 151 mm, h= 60 mm, stainless steel	641212
270 ml, weight ~62 g, Ø 137 mm, h= 22 mm, stainless steel	YWP03G
350 ml, weight ~75 g, Ø 180 mm, h= 22 mm, stainless steel	YWP04G
85 ml, weight ~11 g, Ø 83 mm, h= 23 mm, aluminum	YWP06G
180 ml, weight ~32 g, Ø 90 mm, h= 48 mm, aluminum	YWP05G



Original



# EG-/EU-Konformitätserklärung EC / EU Declaration of Conformity

Hersteller  
Manufacturer Sartorius Lab Instruments GmbH & Co. KG  
37070 Goettingen, Germany

erklärt in alleiniger Verantwortung, dass das Betriebsmittel  
*declares under sole responsibility that the equipment*

Geräteart  
Device type Elektronische Laborwaage  
Electronically laboratory balance

Baureihe  
Type series ENTRISx-1S, ENTRISxl-1S  
x = 64, 124, 153, 224, 323, 423, 623, 822, 2201, 2202, 3202, 4202, 5201, 6202, 8201

in der von uns in Verkehr gebrachten Ausführung allen einschlägigen Bestimmungen der folgenden Europäischen Richtlinien – einschließlich deren zum Zeitpunkt der Erklärung geltenden Änderungen – entspricht und die anwendbaren Anforderungen folgender harmonisierter Europäischer Normen erfüllt:  
*in the form as delivered fulfils all the relevant provisions of the following European Directives – including any amendments valid at the time this declaration was signed – and meets the applicable requirements of the harmonized European Standards listed below:*

2014/30/EU Elektromagnetische Verträglichkeit | *Electromagnetic compatibility*  
EN 61326-1:2013

2011/65/EU Beschränkung der Verwendung bestimmter gefährlicher Stoffe in Elektro- und Elektronikgeräten (RoHS)  
*Restriction of the use of certain hazardous substances in electrical and electronic equipment (RoHS)*  
EN 50581:2012

2014/35/EU Elektrische Betriebsmittel zur Verwendung innerhalb bestimmter Spannungsgrenzen  
*Electrical equipment designed for use within certain voltage limits*  
EN 61010-1:2010

Statt 2014/35/EU für | *instead of 2014/35/EU for* ENTRISxl-1S:

2006/42/EG  
2006/42/EC Maschinen  
*Machines*  
EN ISO 12100:2010, EN 61010-1:2010

The Person, die bevollmächtigt ist, die technischen Unterlagen zusammenzustellen:

*The person authorised to compile the technical file:* Sartorius Lab Instruments GmbH & Co. KG  
International Certification Management  
37070 Goettingen, Germany

Jahreszahl der CE-Kennzeichenvergabe | *Year of the CE mark assignment:* 16

Sartorius Lab Instruments GmbH & Co. KG  
Goettingen, 2016-04-20

Dr. Reinhard Baumfalk  
Vice President R&D

Dr. Dieter Klausgrete  
Head of International Certification Management

Diese Erklärung bescheinigt die Übereinstimmung mit den genannten EG- und EU-Richtlinien, ist jedoch keine Zusicherung von Eigenschaften. Bei einer mit uns nicht abgestimmten Änderung des Produktes verliert diese Erklärung ihre Gültigkeit. Die Sicherheitshinweise der zugehörigen Produktdokumentation sind zu beachten.

*This declaration certifies conformity with the above mentioned EC and EU Directives, but does not guarantee product attributes. Unauthorised product modifications make this declaration invalid. The safety information in the associated product documentation must be observed.*

# FCC Supplier's Declaration of Conformity



**Device type** Electronically laboratory balance

**Model** ENTRISx-1S, ENTRISxl-1S  
x = 64, 124, 153, 224, 323, 423, 623, 822, 2201, 2202, 3202, 4202, 5201, 6202, 8201

**Party issuing Supplier's Declaration of Conformity /  
Responsible Party – U.S. Contact Information**

Sartorius Corporation  
5 Orville Dr Suite 200  
11716 Bohemia, NY  
USA  
Telephone: +1.631.254.4249

**FCC Compliance Statement**

This device complies with Part 15 of the FCC Rules. Operation is subject to the following two conditions: (1) This device may not cause harmful interference, and (2) this device must accept any interference received, including interference that may cause undesired operation.

**Information to the user**

Note: This equipment has been tested and found to comply with the limits for a **class B** digital device, pursuant to part 15 of the FCC Rules. These limits are designed to provide reasonable protection against harmful interference in a residential installation. This equipment generates, uses and can radiate radio frequency energy and if not installed and used in accordance with the instructions, may cause harmful interference to radio communications. However, there is no guarantee that interference will not occur in a particular installation. If this equipment does cause harmful interference to radio or television reception, which can be determined by turning the equipment off and on, the user is encouraged to try to correct the interference by one or more of the following measures:

- Reorient or relocate the receiving antenna.
- Increase the separation between the equipment and receiver.
- Connect the equipment into an outlet on a circuit different from that to which the receiver is connected.
- Consult the dealer or an experienced radio/TV technician for help.

Connections between the device and peripherals must be made using shielded cables in order to maintain compliance with FCC radio frequency emission limits.

Any modifications made to this device that are not approved by Sartorius may void the authority granted to the user by the FCC to operate this equipment.



# Certificate of Compliance

**Certificate:** 1720507 **Master Contract:** 167555  
**Project:** 2692851 **Date Issued:** January 17, 2014  
**Issued to:** Sartorius Lab Instruments  
GmbH & Co. KG  
94-108 Weender Landstrasse  
Goettingen, 37075  
Germany  
Attention: Dr. Dieter Klausgrete

*The products listed below are eligible to bear the CSA Mark shown with adjacent indicators 'C' and 'US' for Canada and US or with adjacent indicator 'US' for US only or without either indicator for Canada only.*



*Timothy Stafrace*  
Issued by: Timothy Stafrace, C.E.T.

## **PRODUCTS**

- CLASS 3862 11** - INFORMATION TECHNOLOGY EQUIPMENT - (CSA 60950-1-03, 1st ed)  
**CLASS 3862 91** - INFORMATION TECHNOLOGY EQUIPMENT(UL 60950-1 - First Edition) - Certified to US Standards

Scales, Models ENTRIS<sub>xxxxxy</sub>-IS, ED<sub>xxxxxy</sub>-zzzzzz, GK<sub>xxxxxy</sub>-zzzzzz, GW<sub>xxxxxy</sub>-zzzzzz (where x may be any number 0 to 9 or blank, y may be any letter A to Z or letter i and z may be any number 0 to 9, letter A to Z or blank), rated 12-30 Vdc SELV, for use with the following power supplies: FRIWO, type 153779 (Sartorius model 6971790) or type 153045 (Sartorius model 6971991) or Certified/Listed external LPS power supplies rated 12-30 Vdc, 0.22 A minimum output.

## **APPLICABLE REQUIREMENTS**

- CAN/CSA C22.2 No 60950-1-03 - Information Technology Equipment – Safety Part 1: General Requirements  
ANSI/UL 60950-1 1st Ed (2003) - Information Technology Equipment – Safety Part 1: General Requirements



Sartorius Lab Instruments GmbH & Co. KG  
Otto-Brenner-Strasse 20  
37079 Goettingen, Germany

Phone: +49.551.308.0  
www.sartorius.com

The information and figures contained in these instructions correspond to the version date specified below.

Sartorius reserves the right to make changes to the technology, features, specifications and design of the equipment without notice. Masculine or feminine forms are used to facilitate legibility in these instructions and always simultaneously denote the other gender as well.

Copyright notice:

This instruction manual, including all of its components, is protected by copyright. Any use beyond the limits of the copyright law is not permitted without our approval. This applies in particular to reprinting, translation and editing irrespective of the type of media used.

© Sartorius Germany

Last updated:  
10 | 2018