

# Thermo Scientific Solaris 2000 / 4000

## Instruction Manual

70900190-b • 04 / 2019

# Contents

<b>Preface</b> .....	<b>6</b>
<b>Intended Use</b> .....	<b>6</b>
<b>Signal Words and Symbols</b> .....	<b>6</b>
Symbols used on Shaker and Accessories .....	6
Symbols used in the Instruction Manual .....	7
<b>Safety Instructions</b> .....	<b>7</b>
<hr/>	
<b>1. Technical Specifications</b> .....	<b>11</b>
<b>1. 1. Technical Data</b> .....	<b>11</b>
Thermo Scientific Solaris 2000 Shaker .....	11
Thermo Scientific Solaris 4000 Shaker .....	12
<b>1. 2. Accessories</b> .....	<b>13</b>
1. 2. 1. Platforms .....	13
1. 2. 2. Clamps .....	14
1. 2. 3. Test Tube Racks .....	16
<b>1. 3. Directives and Standards</b> .....	<b>18</b>
<b>1. 4. Product Overview</b> .....	<b>19</b>
1. 4. 1. Solaris 2000 .....	19
1. 4. 2. Solaris 4000 .....	19
1. 4. 3. Connections .....	20
<hr/>	
<b>2. Transport and Set Up</b> .....	<b>21</b>
<b>2. 1. Unpacking</b> .....	<b>21</b>
Items Supplied .....	21
<b>2. 2. Location</b> .....	<b>22</b>
<b>2. 3. Transporting</b> .....	<b>23</b>
<b>2. 4. Leveling</b> .....	<b>23</b>
<b>2. 5. Mains Connection</b> .....	<b>24</b>
<b>2. 6. Initial Startup</b> .....	<b>24</b>
<b>2. 7. Storage</b> .....	<b>27</b>
<b>2. 8. Shipping</b> .....	<b>27</b>

---

<b>3. Operation</b> .....	<b>28</b>
<b>3. 1. Power on / off</b> .....	<b>28</b>
<b>3. 2. Graphical User Interface</b> .....	<b>28</b>
3. 2. 1. Status .....	28
3. 2. 2. Settings .....	30
3. 2. 3. Programs .....	33
<b>3. 3. Accessories</b> .....	<b>41</b>
3. 3. 1. Platform Installation .....	41
3. 3. 2. Clamp and Vessel Installation .....	44
3. 3. 3. Test Tube Rack Clamp Installation .....	46
3. 3. 4. Microplate / Deepwell-Plate Installation .....	47
<b>3. 4. Loading and Normal Use</b> .....	<b>48</b>
Loading .....	48
Normal Use .....	49

---

<b>4. Maintenance and Care</b> .....	<b>52</b>
<b>4. 1. Basics</b> .....	<b>53</b>
Inspection of Accessories .....	53
<b>4. 2. Cleaning</b> .....	<b>54</b>
Touchscreen .....	54
<b>4. 3. Disinfection</b> .....	<b>55</b>
<b>4. 4. Decontamination</b> .....	<b>55</b>
<b>4. 5. Autoclaving</b> .....	<b>56</b>
<b>4. 6. Service</b> .....	<b>57</b>
<b>4. 7. Shipping and Disposal</b> .....	<b>57</b>

---

<b>5. Troubleshooting</b> .....	<b>58</b>
---------------------------------	-----------

# List of Figures

Figure 1: Overview Solaris 2000 . . . . .	19
Figure 2: Overview Solaris 4000 . . . . .	19
Figure 3: Rear View (left: Solaris 4000, right: Solaris 2000) . . . . .	20
Figure 4: Set up clearance of 8 cm (3 in) . . . . .	22
Figure 5: How to carry a shaker . . . . .	23
Figure 6: Initial startup . . . . .	24
Figure 7: Initial startup - language . . . . .	25
Figure 8: Initial startup - unit name . . . . .	25
Figure 9: Initial startup - region . . . . .	25
Figure 10: Initial startup - set date display format . . . . .	26
Figure 11: Initial startup - set date . . . . .	26
Figure 12: Initial startup - set time . . . . .	26
Figure 13: Initial startup - installation instruction . . . . .	26
Figure 14: Home Screen of the Graphical User Interface (GUI) . . . . .	28
Figure 15: Settings . . . . .	30
Figure 16: Speed setpoint . . . . .	30
Figure 17: Orbit calculator . . . . .	31
Figure 18: Orbit calculated . . . . .	31
Figure 19: Calculate custom sized orbit . . . . .	31
Figure 20: Time Mode . . . . .	32
Figure 21: Menu Bar Customization . . . . .	33
Figure 22: Files and Info . . . . .	33
Figure 23: Programs . . . . .	34
Figure 24: Create program . . . . .	34
Figure 25: Add step . . . . .	35
Figure 26: Delete program . . . . .	35
Figure 27: Program quick view . . . . .	36
Figure 28: Program complete . . . . .	36
Figure 29: Select programs for import . . . . .	36
Figure 30: Program import complete . . . . .	37
Figure 31: Select programs for export . . . . .	37
Figure 32: Program export complete . . . . .	37
Figure 33: Event Log . . . . .	38
Figure 34: Filter event log . . . . .	38

Figure 35: Select event log for export . . . . .	39
Figure 36: Insert USB drive for export . . . . .	39
Figure 37: Charts . . . . .	40
Figure 38: Example of an universal platform . . . . .	42
Figure 39: Universal platform installed on a Solaris 2000 (left) and a Solaris 4000 (right) shaker . . . . .	42
Figure 40: Dual Stack Platform Assembly . . . . .	43
Figure 41: Dual stack platform on a Solaris 4000 shaker . . . . .	44
Figure 42: Clamp details with 2 springs. . . . .	45
Figure 43: Test Tube Rack Clamp Assembly . . . . .	46
Figure 44: Microplate / Deepwell-plate assembly . . . . .	47
Figure 45: Example for a well loaded platform . . . . .	48
Figure 46: Example for a poorly loaded platform. . . . .	49
Figure 47: Solaris 2000 – Normal Use . . . . .	50
Figure 48: Solaris 4000 – Normal Use . . . . .	51

## List of Tables

Table 1: Technical Data Solaris 2000 . . . . .	11
Table 2: Technical Data Solaris 4000 . . . . .	12
Table 3: Available platforms . . . . .	13
Table 4: Available clamps for Solaris 2000 platforms . . . . .	14
Table 5: Available clamps for Solaris 4000 platforms . . . . .	15
Table 6: Available test tube racks for Solaris 2000 platforms . . . . .	16
Table 7: Available test tube racks for Solaris 4000 platforms . . . . .	17
Table 8: Directives and Standards . . . . .	18
Table 9: Items Supplied . . . . .	21
Table 10: Autoclavability of materials . . . . .	56
Table 11: Troubleshooting . . . . .	59

# Preface

## Intended Use

A device used in research and manufacturing to shake solutions in a 2D orbit while controlling speed and time in applications.



This shaker must be operated by trained personnel only.

## Signal Words and Symbols

Signal Word	Degree of Hazard
<b>WARNING</b>	Indicates a hazardous situation that, if not avoided, could result in death or serious injury.
<b>CAUTION</b>	Indicates a hazardous situation that, if not avoided, could result in minor or moderate injury.
<b>NOTICE</b>	Indicates information considered important, but not hazard-related.







## Symbols used on Shaker and Accessories

Observe the information contained in this instruction manual to keep yourself and your environment safe.

	Refer to instruction manual
	Disconnect mains plug
	General hazard

## Symbols used in the Instruction Manual

Observe the information contained in the instruction manual to keep yourself and your environment safe.

	General hazard		Electrical hazard
	Biological hazard		Danger of cuts
	Hazard caused by flammable materials		Indicates information considered important, but not hazard-related.

## Safety Instructions



### WARNING

Not following these safety instructions can lead to hazardous situations that, if not avoided, could result in death or serious injury.

- Observe the safety instructions.
- The shaker is to be used for its intended use only. Improper use can cause damage, contamination, and injuries with fatal consequences.
- The shaker must be operated by trained personnel only.
- It is the obligation of the operator to make sure, that the proper personal protective equipment is used. Mind the “Laboratory Biosafety Manual” of the World Health Organization (WHO) and the regulations in your country.



### WARNING

**Damage from wrong power supply.**

Make sure that the shaker is plugged only into sockets which have been properly grounded.



**WARNING**

**Risk from handling hazardous substances.**

When working with corrosive samples (salt solutions, acids, bases), the accessories and the shaker have to be cleaned thoroughly.

- The shaker is neither inert nor protected against explosion. Never use the shaker in an explosion-prone environment.
- Do not shake toxic or radioactive materials or any pathogenic micro-organisms without suitable safety precautions.
- If shaking any hazardous materials mind the "Laboratory Biosafety Manual" of the World Health Organization (WHO) and any local regulations. When shaking microbiological samples from the Risk Group II (according to the "Laboratory Biosafety Manual" of the World Health Organization (WHO)), aerosol-tight biological seals have to be used. Look on the internet page of the World Health Organization ([www.who.int](http://www.who.int)) for the "Laboratory Biosafety Manual". For materials in a higher risk group, extra safety measures must be taken.
- If toxins or pathogenic substances have contaminated the shaker or its parts, appropriate disinfection measures have to be taken ("Decontamination" on page 55; „Disinfection" on page 55).
- If a hazardous situation occurs, turn off the power supply to the shaker and leave the area immediately.



**WARNING**

**Damage to health from infectious substances.**

If an accidental spill places liquids or other materials under the platform, immediately power off the shaker, unplug it, and remove the platform ("Platforms" on page 13).

Clean up the spill following your regular laboratory procedures. Use proper personal protective equipment.



**WARNING**

**Damage to health from shaking explosive or flammable materials or substances.**

Do not shake explosive or flammable materials or substances.



**CAUTION****Cutting injuries from glass shards.**

A disengaged platform and accessories, like clamps, can lead to broken glass if vessels fall off the shaker.

Make sure that the platform and accessories are installed properly by using the correct tools and screws. Make sure that the clamps are capable to hold the load of the vessel and sample at chosen speed. Clamps with your individually configured load may have lower speed capability than the stability limitation of the shaker. Refer to "3. 4. Loading and Normal Use" on page 48.

Pay attention to any unusual sound. This can indicate a disengaged platform or accessories.

---

**CAUTION****Damage to device or malfunction due to a damaged touchscreen.**

- Do not operate the device if the touchscreen is damaged.
  - Power off the shaker. Disconnect the mains plug. Have the touchscreen replaced by an authorized service technician.
- 

**CAUTION****Biological harm due to broken or leaking vessels.**

Improperly installed accessories can lead to spilled samples.

- Make sure that accessories are installed properly by using the correct tools and screws.
  - Make sure that accessories fit reasonably on the platform.
  - Always use a vessel with an accessory that fits its size.
  - Vessels must be intact and installed properly.
- 

**CAUTION****Safety can be impaired by improper loading and damaged accessories.**

- Always make sure that the load (accessories and samples) is distributed as equally as possible, especially when operating a dual stack platform.
- Do not use accessories which show signs of corrosion or cracks. Contact customer service for further information.
- Use only shakers which have been loaded properly.
- Never overload the shaker.
- Make sure the accessories are installed properly before operating the shaker. Follow the instructions in section „Accessories“ on page 41.

**CAUTION****Physical harm caused by ignoring operative basics.**

- Never operate the shaker without a properly installed platform.
- Never use the shaker if parts of its exterior are damaged or missing.
- Do not move the shaker while it is running.
- Do not lean on the shaker.
- Never load or unload the shaker until it has come to a complete stop and this has been confirmed on the touchscreen.
- Do not put anything on the shaker while it is running.
- Do not touch the platform or any accessories on the shaker while it is running.
- The shaker housing is not to be opened by the operator.

**NOTICE****Protection may be impaired by incompatible accessories.**

Use only accessories for this shaker which have been approved by Thermo Fisher Scientific. For updated lists check [www.thermofisher.com](http://www.thermofisher.com).

**NOTICE****To shut down the shaker:**

Press the STOP key. Turn off the shaker at the main switch. Pull out the power supply plug. In an emergency disconnect the power supply.

# 1. Technical Specifications

## 1.1. Technical Data

### Thermo Scientific Solaris 2000 Shaker



Speed Range	15–525 rpm
Running Time	99 h 59 min (1 min increment) or continuous mode
Noise Level at max. Speed	62 dB (A) (1 m in front of the unit at 1.6 m height)
Maximum Load (incl. Platform, Accessories and Samples)	25 kg (55 lbs)
Electrical Connection	100–240 V, 50 / 60 Hz
Power Consumption	60 W

### Environmental Conditions

For Storage and Shipping	Temperature: -10 °C to 55 °C Humidity: 15% to 85%
For Operation	Use in interior spaces Altitudes of up to 3 000 m above sea level Temperature: 5 °C to 40 °C Humidity: 20% to 80%, non-condensing.
Pollution Degree	2
Overvoltage Category	II
IP	20

### Interfaces

#### USB

#### Ethernet

2x USB-A 2.0

RJ45

### Dimensions

#### Length

#### Width

#### Height

47 cm  
(18.5 in)

37 cm  
(14.5 in)

15 cm  
(5.5 in)

### Weight

20.9 kg (46,0 lbs)

Table 1: Technical Data Solaris 2000

# Thermo Scientific Solaris 4000 Shaker



Speed Range	15–525 rpm
Running Time	99 h 59 min (1 min increment) or continuous mode
Noise Level at max. Speed	62 dB (A) (1 m in front of the unit at 1.6 m height)
Maximum Load (incl. Platform, Accessories and Samples)	43 kg (95 lbs)
Electrical Connection	100–240 V, 50 / 60 Hz
Power Consumption	80 W

## Environmental Conditions

For Storage and Shipping	Temperature: -10 °C to 55 °C Humidity: 15% to 85%
For Operation	Use in interior spaces Altitudes of up to 3000 m above sea level Temperature: 5 °C to 40 °C Max. relative humidity 80% up to 31 °C; decreasing linearly to 50% relative humidity at 40 °C
Pollution Degree	2
Overvoltage Category	II
IP	20

## Interfaces

### USB

### Ethernet

2x USB-A 2.0

RJ45

## Dimensions

### Length

### Width

### Height

65 cm  
(25.6 in)

58 cm  
(22.8 in)

18 cm  
(7 in)

## Weight

75.1 kg (165.5 lbs)

**Table 2:** Technical Data Solaris 4000

## 1. 2. Accessories



### CAUTION

Protection may be impaired by incompatible accessories.  
Use only accessories for this shaker which have been approved by Thermo Fisher Scientific.

For updated lists check [www.thermofisher.com](http://www.thermofisher.com).

### 1. 2. 1. Platforms

Platform	Art. No.
<b>Solaris 2000</b>	
Thermo Scientific Solaris 12x14 Universal Platform	SK1214
Thermo Scientific Solaris 12x14 Dual Stack Universal Platform	SK1214D
Thermo Scientific Solaris 12x14 Dual Stack Universal Platform Upgrade Kit	SK1214DK
Thermo Scientific Solaris 18x18 Universal Platform	SK1818
Thermo Scientific Solaris 18x18 Dual Stack Universal Platform	SK1818D
Thermo Scientific Solaris 18x18 Dual Stack Universal Platform Upgrade Kit	SK1818DK
Thermo Scientific Solaris 18x24 Universal Platform	SK1824
<b>Solaris 4000</b>	
Thermo Scientific Solaris 18x30 Universal Platform	SK1830
Thermo Scientific Solaris 18x30 Dual Stack Universal Platform	SK1830D
Thermo Scientific Solaris 18x30 Dual Stack Universal Platform Upgrade Kit	SK1830DK
Thermo Scientific Solaris 36x24 Universal Platform	SK3624
<b>Spare Kits</b>	
Clamp Spare Kit (Screws)	SK1001
Platform Spare Kit for SK2000 (Platform Screws, Tool, Thread Locker)	SK0100
Platform Spare Kit for SK4000 (Platform Screws, Tool, Thread Locker)	SK0101

Table 3: Available platforms

## 1. 2. 2. Clamps



### For Solaris 2000 Platforms

	Art. No.	Universal			Dual Stack	
		12x14	18x18	18x24	12x24	18x18
Microplate / Deep-Well Plate	30175	5	10	14	8	20
10 ml Erlenmeyer	30150BI	72	113	157	140	226
25 ml Erlenmeyer	30151	42	64	80	80	124
50 ml Erlenmeyer	30152BI	42	64	80	80	124
125 ml Erlenmeyer	30153	15	32	40	30	52
250 ml Erlenmeyer	30154BI	9	16	24	16	32
300 ml Erlenmeyer	30155	9	16	20	16	32
500 ml Erlenmeyer	30156BI	9	16	20	16	32
1 l Erlenmeyer	30157BI	4	9	10	8	16
2 l Erlenmeyer	30158	3	5	6	–	–
4 l Erlenmeyer	30159	1	4	4	–	–
6 l Erlenmeyer	30160	1	2	2	–	–
2800 ml Fernbach Flask	30162	1	4	4	–	–
Low form culture Flask 2,5 l	30161	1	1	2	–	–
Adhesive mat 9x9	300349	–	–	–	–	–
Adhesive mat 14x14	88881126	–	–	–	–	–

**Table 4:** Available clamps for Solaris 2000 platforms

## For Solaris 4000 Platforms

	Art. No.	Universal		Dual Stack
		18x30	36x24	18x30
Microplate / Deep-Well Plate	30175	18	24	34
10 ml Erlenmeyer	30150BI	203	187	402
25 ml Erlenmeyer	30151	112	187	220
50 ml Erlenmeyer	30152BI	112	187	220
125 ml Erlenmeyer	30153	46	83	92
250 ml Erlenmeyer	30154BI	28	40	56
300 ml Erlenmeyer	30155	28	40	56
500 ml Erlenmeyer	30156BI	28	40	56
1 l Erlenmeyer	30157BI	14	20	28
2 l Erlenmeyer	30158	6	11	12
4 l Erlenmeyer	30159	6	8	–
6 l Erlenmeyer	30160	3	6	–
2800 ml Fernbach Flask	30162	6	8	12
Low Form Culture Flask 2,5 l	30161	3	6	6
Adhesive Mat 9x9	300349	–	–	–
Adhesive mat 14x14	88881126	–	–	–

**Table 5:** Available clamps for Solaris 4000 platforms

## 1. 2. 3. Test Tube Racks



### For Solaris 2000 Platforms

	Art. No.	Universal			Dual Stack	
		12x14	18x18	18x24	12x24	18x18
<b>Half Size</b>						
10–13 mm, Red, 6 x 6 Array	30181	8	12	15	14	24
14–16 mm, Orange, 6 x 6 Array	30183	5	9	11	9	17
17–20 mm, White, 4 x 5 Array	30185	7	11	14	13	21
21–25 mm, Blue, 4 x 4 Array	30187	6	9	11	10	17
26–30 mm, Green, 3 x 3 Array	30189	6	9	12	11	18
Micro Centrifuge, 1.5 ml, Blue, 4 x 6 Array	30191	6	10	13	11	19
<b>Full Size</b>						
10–13 mm, 6 x 12 Array	30180BI	3	7	10	6	13
14–16 mm, 6 x 12 Array	30182	3	4	6	6	8
17–20 mm, 4 x 10 Array	30184	3	5	7	6	8
21–25 mm, 4 x 10 Array	30186	2	3	5	4	6
26–30 mm, 3 x 8 Array	30188	3	4	6	5	8
1.5 mL Micro Centrifuge, 8 x 12 Array	30190	3	5	7	6	9

**Table 6:** Available test tube racks for Solaris 2000 platforms



## For Solaris 4000 Platforms

	Art. No.	Universal		Dual Stack
		18x30	36x24	18x30
<b>Half Size</b>				
10–13 mm, Red, 6 x 6 Array	30181	21	32	40
14–16 mm, Orange, 6 x 6 Array	30183	14	20	26
17–20 mm, White, 4 x 5 Array	30185	18	20	34
21–25 mm, Blue, 4 x 4 Array	30187	14	22	25
26–30 mm, Green, 3 x 3 Array	30189	15	24	30
1.5 ml Micro Centrifuge, Blue, 4 x 6 Array	30191	18	24	34
<b>Full Size</b>				
10–13 mm, 6x12 Array	30180BI	14	20	26
14–16 mm, 6x12 Array	30182	9	12	16
17–20 mm, 4x10 Array	30184	9	15	18
21–25 mm, 4x10 Array	30186	7	9	13
26–30 mm, 3x8 Array	30188	7	10	13
1.5 ml Micro Centrifuge, 8x12 Array	30190	9	12	17

**Table 7:** Available test tube racks for Solaris 4000 platforms

### 1. 3. Directives and Standards

Region	Directive	Standards
Europe	2006/42/EC Machinery Directive 2014/35/EU Low Voltage (Protective Goals) 2014/30/EC Electromagnetic Compatibility (EMC) 2011/65/EC RoHS Directive on the Restriction of the use of certain Hazardous Substances in electrical and electronic equipment	EN 61010-1 3rd Edition IEC 61010-2-051 3rd Edition EN 61326-1 Class B EN ISO 14971 EN ISO 9001
North America		ANSI/UL 61010-1 3rd Edition IEC 61010-2-051 3rd Edition IEC 61326-1 Class B CFR 47 FCC 15 EMC EN ISO 14971 EN ISO 9001
Japan		IEC 61010-1 3rd Edition IEC 61010-2-051 3rd Edition IEC 61326-1 Class B EN ISO 14971 EN ISO 9001

**Table 8:** Directives and Standards

NOTE: This equipment has been tested and found to comply with the limits for a Class A digital device, pursuant to part 15 of the FCC Rules. These limits are designed to provide reasonable protection against harmful interference when the equipment is operated in a commercial environment. This equipment generates, uses, and can radiate radio frequency energy and, if not installed and used in accordance with the instruction manual, may cause harmful interference to radio communications. Operation of this equipment in a residential area is likely to cause harmful interference in which case the user will be required to correct the interference at his own expense.

# 1. 4. Product Overview

## 1. 4. 1. Solaris 2000

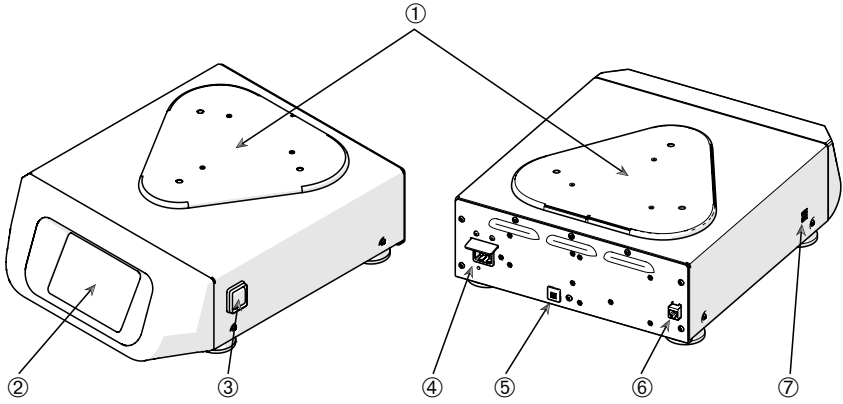

- ① Platform Mounting Plate; ② Graphical User Interface (GUI) Display;
- ③ Power Supply Switch; ④ Mains Connection; ⑤ Fuse; ⑥ Ethernet; ⑦ USB

Figure 1: Overview Solaris 2000

## 1. 4. 2. Solaris 4000

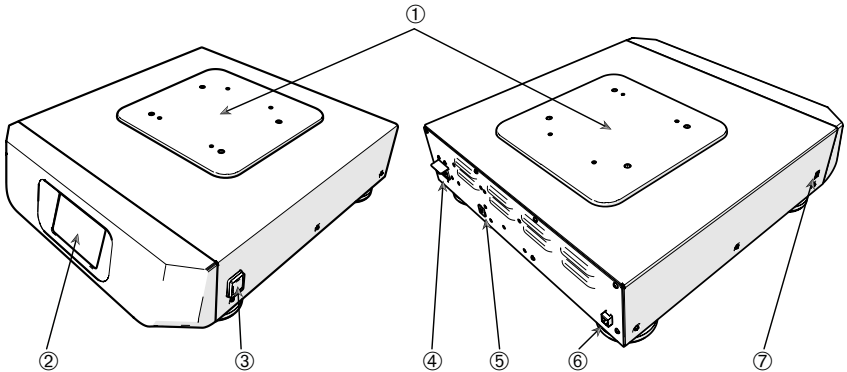

- ① Platform Mounting Plate; ② Graphical User Interface (GUI) Display;
- ③ Power Supply Switch; ④ Mains Connection; ⑤ Fuse (resettable); ⑥ Ethernet; ⑦ USB

Figure 2: Overview Solaris 4000

### 1. 4. 3. Connections



① Mains Connection; ② Fuse; ③ Ethernet

Figure 3: Rear View (left: Solaris 4000, right: Solaris 2000)

#### **Mains Connection**

The shaker requires a 100–240 V, 50 / 60 Hz power source. Power supply cables are supplied.

**WARNING** Damage from wrong mains supply or power supply plug. Make sure that the shaker is plugged only into sockets which have been properly grounded. Do not operate the shaker with a damaged or an inadequately rated power supply cable.

The mains plug must be freely accessible at all times.

To eliminate hazard of electrical shock, make sure the surface around the shaker is dry. In the event of accidental spilling or splashing of liquids, disconnect the shaker from the power source, clean up and neutralize the spilled liquids before continuing. Disconnect the shaker from the power source when not in use.

#### **Fuse**

The fuse can be resetted if it has tripped. The fuse will trip if overvoltage occurs. The shaker will not operate again until the fuse is pushed back in its proper position.

#### **Ethernet**

The shaker has a RJ45 ethernet connection, which can be used to connect to a Local Area Network (LAN). Use only equipment conform to the IEC 60950-1 standard with the RJ45 ethernet connection. The RJ45 ethernet connection is prepared for future use when an according update of the software will be available.

#### **USB**

The shaker has 2 USB-A 2.0 ports, which can be used with an USB drive. Use only equipment conform to the IEC 60950-1 standard with the USB ports.

## 2. Transport and Set Up



It is your responsibility to make sure that the shaker is set up properly.

### NOTICE

The shipping carton should be inspected upon delivery. When received, carefully examine for any shipping damage before unpacking. If damage is discovered, the delivering carrier should specify and sign for the damage on your copy of the delivery receipt.

Open the carton carefully making certain that all parts (“Table 9: Items Supplied”) are accounted for before packaging materials are discarded. After unpacking, if damage is found, report it to the carrier and request a damage inspection.

Important: Failure to request an inspection of damage within a few days after receipt of shipment absolves the carrier from any liability for damage. You must call for a damage inspection.

### 2. 1. Unpacking

Use the packing list when unpacking to verify that the complete unit has been received. Do not discard packing materials until all is accounted for.

#### Items Supplied

Item	Quantity
Shaker	1
Power Supply Cable	1
Universal Platform	1
Screws for Platform	3
Thread Locker	1
Manuals print en	1
Manuals on USB	1

Table 9: Items Supplied

If any items are missing, contact Thermo Fisher Scientific.

## 2. 2. Location

**CAUTION** Protection can be impaired due to reduced stability of plastic exposed to ultraviolet rays. Do not subject the shaker and plastic accessories to direct sunlight or other sources of ultraviolet rays.

Put the shaker on a level table or bench capable of supporting the weight of the shaker with any accessories and samples while in operation. Place the shaker near an electrical outlet that matches the nameplate requirements. Allow clearance around the unit for free air convection, accessory attachments and user convenience.

Mind the following requirements for setting up the unit:

- The shaker requires a clear area of 8 cm (3 in) for proper ventilation on all sides.

**WARNING** Hazardous substances must be kept out of this zone while shaking.

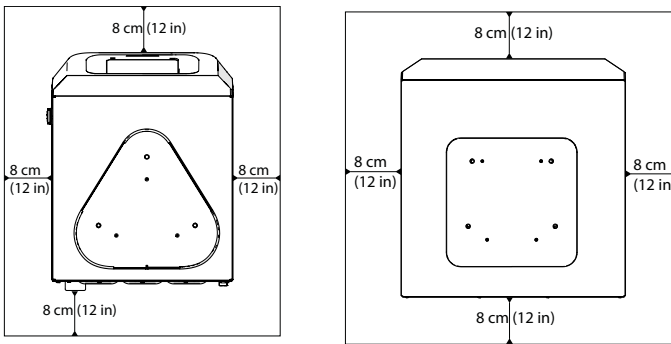

Figure 4: Set up clearance of 8 cm (3 in)

- The supporting surface must:
  - » be clean,
  - » be stable, solid, rigid and free of resonance,
  - » be suitable for horizontal set up of the shaker,
  - » hold the weight of the shaker.
- The shaker is to be operated only indoors.
- The shaker is not to be exposed to heat and strong sunlight.
- The set up location must be well ventilated at all times.
- The mains plug must be freely accessible at all times.

## 2. 3. Transporting

**CAUTION** Physical harm caused by dropping the shaker. Always lift the shaker from both sides. Never lift the shaker by its front panel or an installed platform.

**CAUTION** Safe use of the shaker is impaired after transport or storage in humid conditions. Let the equipment dry out for at least 2 h before operating.

**NOTICE** Always remove the platform and other accessories before moving the shaker. If you do not remove the platform, you might damage the platform mounting plate or the shaking mechanism.

Impact can damage the unit.

Transport the shaker in an upright position and if possible in original packaging.

Due to its weight, the Solaris 4000 shaker must be carried by two people.

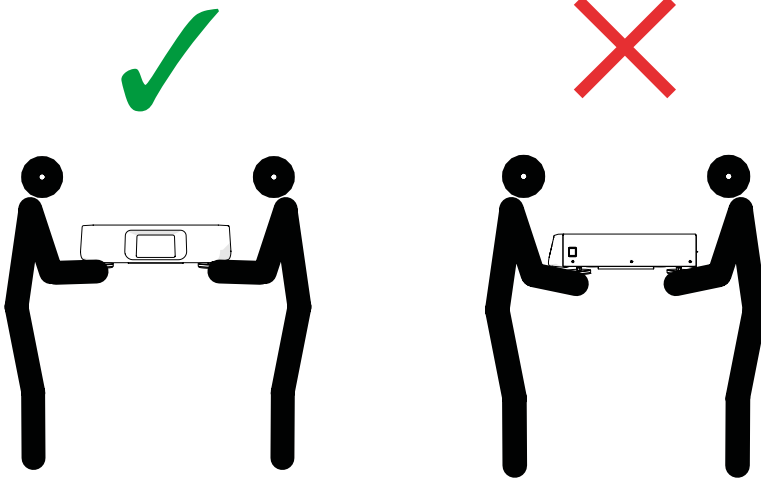

Figure 5: How to carry a shaker

## 2. 4. Leveling

The shaker cannot be leveled by itself. The shaker requires a leveled supporting surface for proper setup.

**NOTICE** Do not put anything between the shaker feet and the supporting surface to level the shaker.

## 2. 5. Mains Connection

The shaker requires a 100–240 V, 50 / 60 Hz power source. Power supply cables are supplied.

**WARNING** Damage from wrong mains supply or power supply plug. Make sure that the shaker is plugged only into sockets which have been properly grounded. Do not operate the shaker with a damaged or an inadequately rated power supply cable.

To connect the shaker to the power supply follow this procedure:

1. Turn off the power supply switch located on the right side.
2. Make sure that the cable specification agrees with the safety standards of your country.
3. Make sure that the voltage and frequency are the same as the figures on the rating plate.

The mains plug must be freely accessible at all times.

To eliminate hazard of electrical shock, make sure the surface around the shaker is dry. In the event of accidental spilling or splashing of liquids, disconnect the shaker from the power source, clean up and neutralize the spilled liquids before continuing.

Disconnect the shaker from the power source when not in use.

## 2. 6. Initial Startup

Complete the following steps before using the unit:

1. Power on the unit, the thermo scientific logo is displayed. Tap **Start Setup**.



Figure 6: Initial startup



2. Select the desired language on the Language screen. Tap **Next**.



Figure 7: Initial startup - language

3. Enter the unit name on the Unit Name dialog box. Tap **Next**.

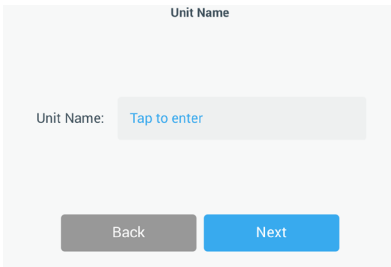

Figure 8: Initial startup - unit name

4. Enter city and country in the text field. You can also select from a list of suggestions displayed while making your entry. Tap **Next**.

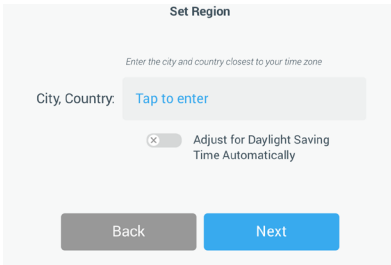

Figure 9: Initial startup - region

5. Select the desired date format. Tap **Next**.

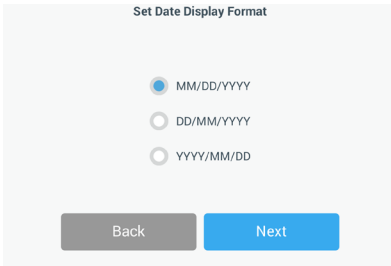

Figure 10: Initial startup - set date display format

6. Select the current date. Tap **Next**.

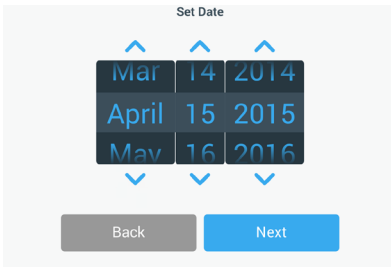

Figure 11: Initial startup - set date

7. Select the desired time format and set the current time. Tap **Next**.

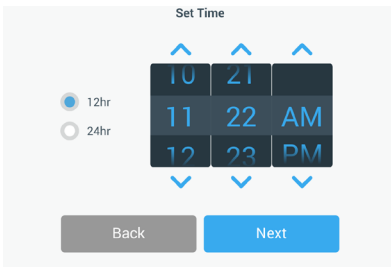

Figure 12: Initial startup - set time

8. An Installation Instruction window is displayed. Tap **Next**.

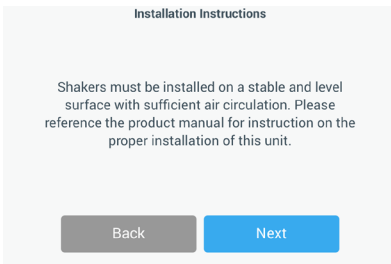

Figure 13: Initial startup - installation instruction

9. Setup is complete. Tap **Finish**.

## 2.7. Storage



### CAUTION

When you remove the shaker and accessories from use, clean and, if necessary, disinfect or decontaminate the full system. Do not leave the shaker and accessories in an undefined state of contamination. If you are unsure of the process contact the Thermo Fisher Scientific customer service (“Cleaning” on page 54, “Disinfection” on page 55 and “Decontamination” on page 55).

- Before storing the shaker and the accessories, it must be cleaned and, if necessary, disinfected and decontaminated.
- Shaker and accessories must be completely dry before storage.
- Keep the shaker in a clean, dust-free location.
- Keep the shaker on its feet.
- Do not store the shaker in direct sunlight.

## 2.8. Shipping



### CAUTION

Before shipping the shaker and accessories you must clean and, if necessary, disinfect or decontaminate the full system. Do not leave the shaker and accessories in an undefined state of contamination. If you are unsure of the process contact the Thermo Fisher Scientific customer service (“Cleaning” on page 54, “Disinfection” on page 55 and “Decontamination” on page 55).

Before shipping the shaker:

- The shaker must be clean and decontaminated.
- You must confirm the decontamination with a decontamination certificate. A decontamination certificate can be retrieved from the Thermo Fisher Scientific customer service.

# 3. Operation

## 3. 1. Power on / off

Push the power switch at the right side to power the shaker on (I) or off (O).

The touchscreen shows the Thermo Scientific logo while booting.

When ready, the touchscreen shows the current status of the shaker.

## 3. 2. Graphical User Interface

The Home Screen below is the default screen:

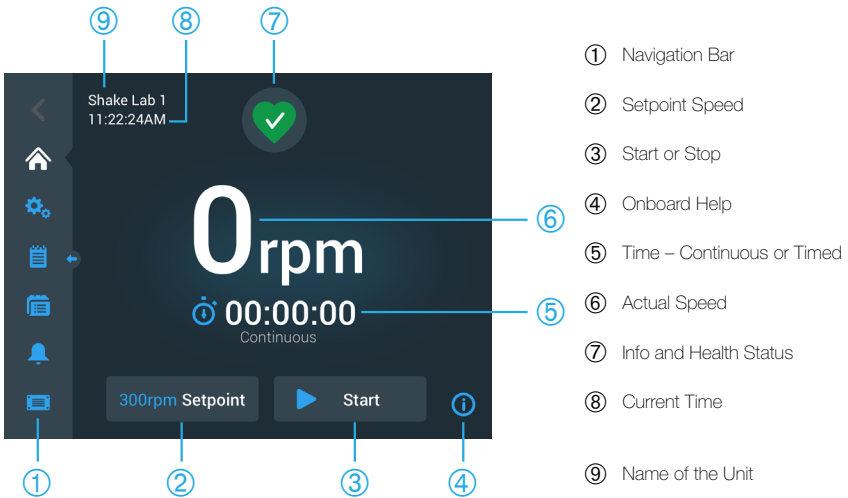

Figure 14: Home Screen of the Graphical User Interface (GUI)

To start the shaker with the set parameter press the **▶ Start** button. To stop the shaker at any time press the **■ Stop** button.

### 3. 2. 1. Status

When the shaker is in good health, the touchscreen display shows a green heart icon in the Info and Health Status area (⑦ in Figure 14). Tapping the green heart icon opens the status screen. The status screen provides a full set of information on the shaker.

## Alert

When an alert is issued, the touchscreen display shows a yellow bar on top of the current screen. After a short time, the yellow alert bar goes away. Only the yellow triangle indicates that alerts exist for the shaker. The triangle icon has a blue circle with a white border that shows the number of active alerts. Tapping the triangle icon in the Info & Health Status area (⑦ in Figure 14) opens a screen listing all alerts that are currently active. The latest alert appears expanded to let you view the full details. You can scroll through the list and tap on any list item to expand it and read more.



## Alarm

When an alarm is issued, the shaker stops immediately to avoid damage to the samples and/or the unit itself. You must acknowledge the message on the touchscreen before you can continue operation.



When an alarm is issued, the touchscreen display shows a red bar on top of the current screen. The Info & Health Status area (⑦ in Figure 14) displays a red alarm bell enclosed by sound waves. Additionally, an audible alarm tone constantly sounds. This can be configured to be silent. (“Alarms and Alerts” on page 30)

Beneath the red alarm bar, a ticker-style message explains the root cause of the problem and provides instructions on how to handle the alarm. A Snooze button appears, allowing you to temporarily silence the alarm. When the alarm condition is not cleared within the snooze period, the audible alarm returns. The duration of the snooze period can be chosen in the settings

## Error

When an error occurs, the shaker stops immediately to avoid damage to the samples and/or the unit itself. The screen is completely filled with a red error message.

You must correct the root cause and restart the shaker by powering it off and on before you can start operation again. Refer to “Troubleshooting” on page 58 for the list of error messages.

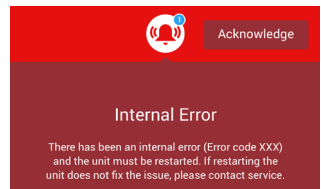

### 3. 2. 2. Settings

The second tab on the navigation panel is the Settings icon. The following screen appears when you select Settings:

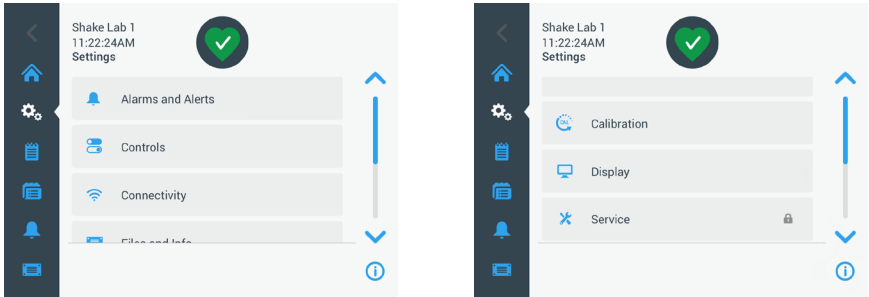

Figure 15: Settings

#### Alarms and Alerts

The Alarm Settings screen provides an option to set the high and low alarm setpoints.

**Volume:** You can change the volume of an alarm by dragging the slider to the left or right. This volume setting will affect alarms, alerts.

**Snooze Timeout:** You can set the snooze timer for 5 minutes, 10 minutes or 15 minutes. The default option is 10 minutes. Tap **Save** to save the changes.

#### Controls

**Speed Setpoint:** The speed setpoint must be between 15–525 rpm. Select the speed and tap **Save**.

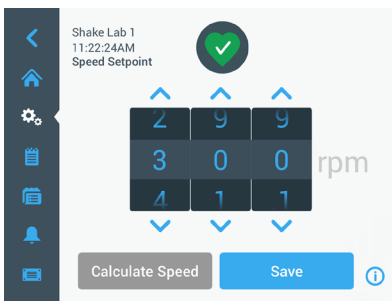

Figure 16: Speed setpoint

**Orbit Calculator:** The calculator enables you to determine the suggested set speed based on the changes to the orbit size when transitioning from one shaker to another.

1. Select the unit of measure in millimeters or inches.

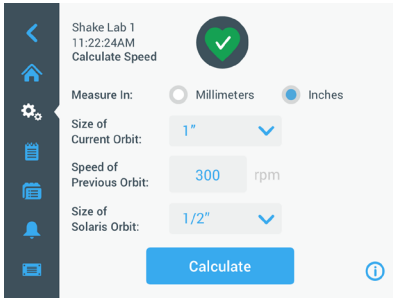

Figure 17: Orbit calculator

2. Select the size of the previous orbit. Tap **Calculate**. The following window appears calculating the speed.

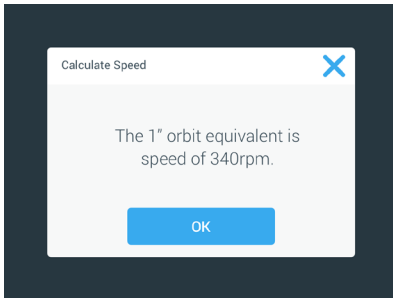

Figure 18: Orbit calculated

3. Tap **OK**.
4. You can calculate the suggested speed for a custom size of the orbit. To calculate custom speed, select Other. Enter the size of the orbit.

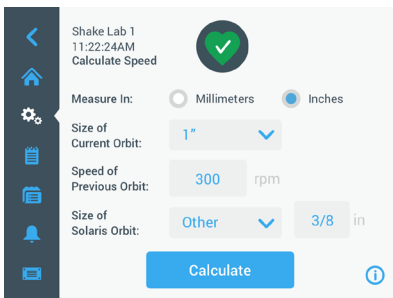

Figure 19: Calculate custom sized orbit

The Calculate Speed window appears displaying the speed for the size entered.

**Time Mode:** This feature allows you to display time in Continuous or Timed mode. If you select timed mode, you can choose to display the elapsed time or remaining time.

Enter the hours and minutes box in the Set Time. Tap **Save**.

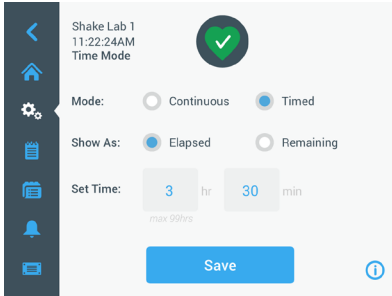

Figure 20: Time Mode

**Auto Restart:** This feature restarts the unit after a power outage. If the Auto Restart is set to **No**, the unit will not restart after a power outage.

## Display

The display settings allows you to change various display options.

**Brightness:** To adjust the brightness level of the display use the slide control or the +/- buttons.

**Language:** To change the display language, tap the Language button and select the desired language.

**Date:** To set the date, tap the Date button.

**Date Format:** To set the date format, tap the Date Format button.

**Time:** To set the time and time format, tap the Time button.

**Region:** This is used to set the region the unit is operated.

**Unit Name:** To enter or change the unit name, tap the Unit Name button.

**Menu Bar Customization:** This is used to customize the bottom 2 icons in the main navigation bar.



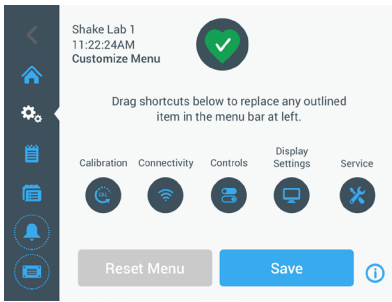

Figure 21: Menu Bar Customization

**Sleep Mode:** This is used to put the display to sleep after 15 minutes of inactivity.

### Files and Info

This provides information of the serial number, H.M.I. (Human-Machine Interface), main controller and parameter. You can **factory reset** your settings from this screen. Resetting to factory defaults will erase all settings except event log and usage.

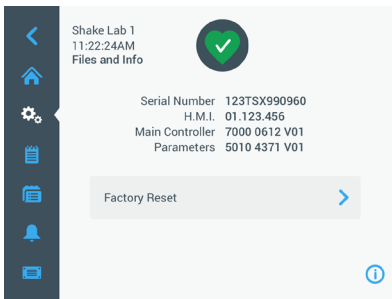

Figure 22: Files and Info

### Service

The service settings are restricted and can be accessed by authorized service technicians. The authorized service technician can update the firmware.

### **3. 2. 3. Programs**

Programs displays the list of programs. You can create, edit, delete, import and export a program. The following screen displays the programs created:

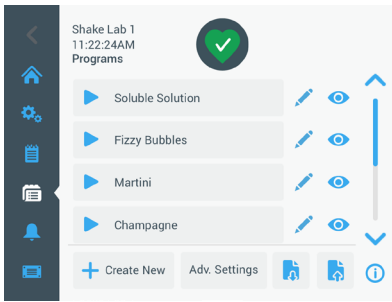

Figure 23: Programs

The eye icon allows you to view the program.

### Creating a Program

You can create and store up to 99 programs.

1. Select **Create New** button.
2. Enter the name of the program.

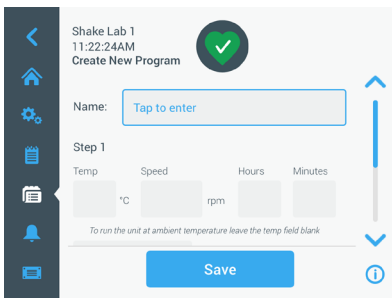



Figure 24: Create program

3. Enter the time and the speed. Enter the duration of the program in hours and minutes.

To add an extra step in your program, scroll down and tap on the **Add Step** button

4. Tap **Save** to save the program.

### Editing a Program

1. Tap the pencil icon  beside the program you want to edit.
2. Edit the required fields. Tap **Save**. The program is saved with the new changes.
3. You can add a step by selecting **Add Step** at the bottom of the screen. Scroll the screen to see the **Add Step** button if there are more than 3 steps.

**NOTICE** If during shaking operation with several steps an alarm or an error message occurs the shaker will automatically stop. If an alert occurs shaking operation will continue.

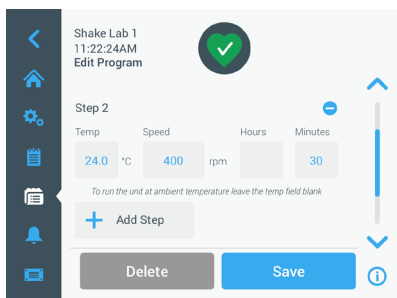

Figure 25: Add step

## Deleting a Program

1. Tap the pencil icon beside the program you want to edit.
2. Tap **Delete**. A window appears asking for confirmation.

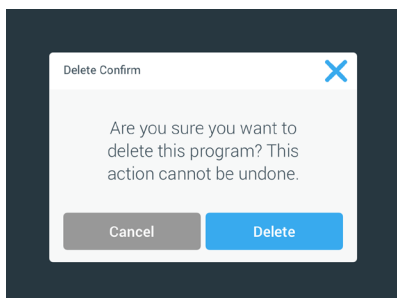



Figure 26: Delete program

3. Tap **Delete**. The selected program is deleted.

## Run a Program

1. To run an existing program, select the program you want to run.
2. If you want to see the Quick view of the program, Tap on the eye icon  beside the program.

3. A Program Quick view window appears.

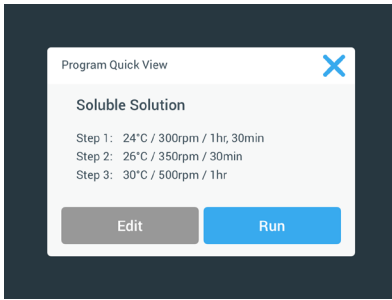

Figure 27: Program quick view

4. Tap **Run** to load the program on the Home screen.

Depending on your chosen **Auto Run** settings the program starts immediately or will start when the **Start** button is tapped on the home screen.

5. When the program is complete, the following window appears. Tap **OK**.

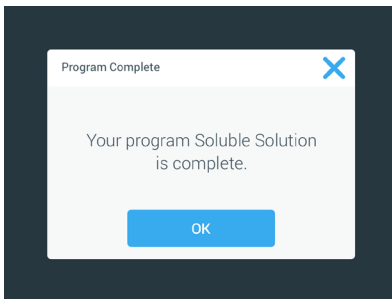

Figure 28: Program complete

## Importing Programs

You can import the programs created in one shaker to another shaker. Ensure that a USB drive is connected.

The following screen shows all the programs saved.

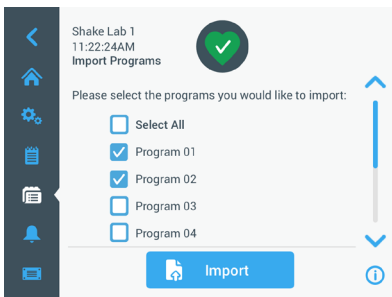

Figure 29: Select programs for import

Select the programs you want to import. Tap **Import**.

After the programs have been imported successfully, the following window appears. Tap **OK**. You may now remove the USB.

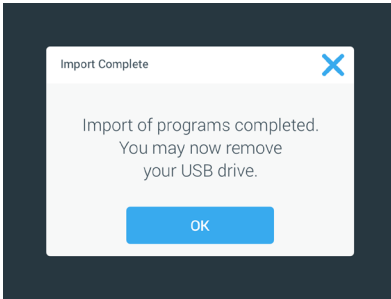

Figure 30: Program import complete

## Exporting Programs

You can export programs from one shaker to another shaker. Ensure that a USB drive is connected.

The following screen is displayed if the USB is connected:

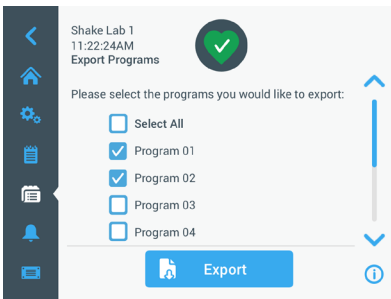

Figure 31: Select programs for export

Select the programs you want to export. Tap **Export**.

The following window appears when the export is completed. Tap **OK**. You may now remove the USB.

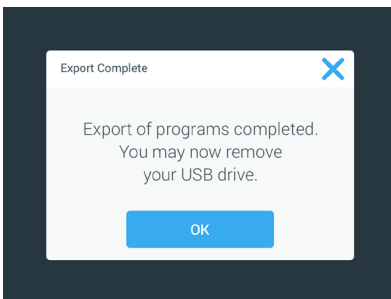

Figure 32: Program export complete

## Event Log

The third tab on the navigation panel is the event log that contains a record of user and system events. The Event Log screen will be displayed once the Event Log icon is tapped.

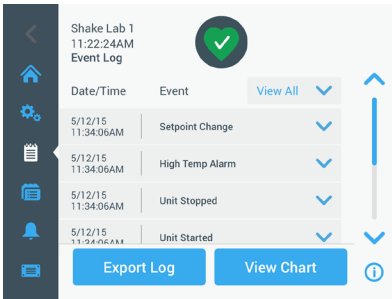

Figure 33: Event Log

This screen displays up to 50 recent events, with date time stamps for each event. Additional information of an individual event can be viewed by selecting the event. Select the dropdown to choose an event type.

The event types can be filtered and categorized into: Alarm, Alerts, Settings, Start/Stop and Programs. When a filter is selected, the View All button on the right changes to Filter ON.

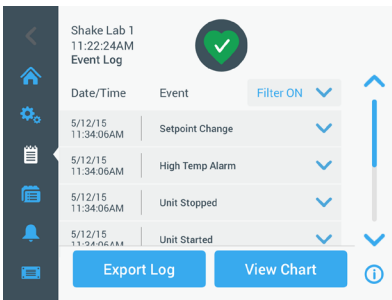

Figure 34: Filter event log

## Export an event

1. Choose an event to be exported from Export dropdown list. Select the export format of the log or report.

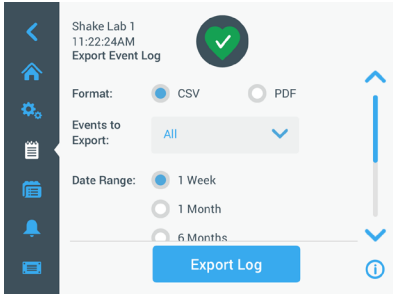

Figure 35: Select event log for export

2. A predefined or custom date range may be selected.
3. Export can be done using a USB drive. An USB drive must be inserted to store the log or report. Tap the **Export Log** button to download the log or report.

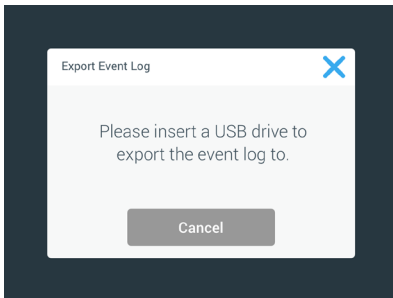

Figure 36: Insert USB drive for export

## Charts

Charts display speed data in graphs. The X-axis displays the time and Y-axis displays the speed.

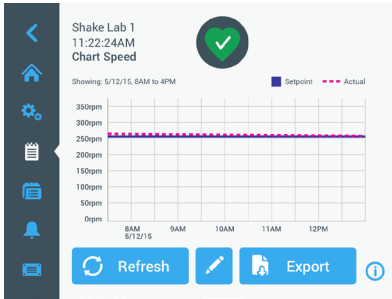

Figure 37: Charts

### Editing the Chart

1. Tap **Edit** if you want to edit the chart.
2. You can select the date range and the time range.
3. Tap **Save** to save the changes or custom settings
4. Tap Export Chart Data to download speed chart. Export can be done using an USB drive. Ensure that an USB drive is inserted to export the data.



### 3. 3. Accessories



#### Physical and biological harm due to broken vessels.

Improperly installed accessories can lead to broken glass and spilled samples.

#### CAUTION

Make sure that accessories are installed properly by using the correct tools and screws.

Make sure that accessories fit reasonably on the platform.

Always use a vessel with the accessory that fits its size.



#### Cutting injuries from sharp edges.

Be cautious while handling with platforms and other accessories.

#### CAUTION



#### Fingers can be pinched by moving platform.

Never put your fingers on or below a platform while it is moving.

#### CAUTION

#### NOTICE

It is your responsibility to make sure that the accessories are installed properly.

Installation procedures described apply to all shaker models listed in this instruction manual until otherwise stated.

Always use the tools and screws supplied with the accessory. If you lose some of these items you can re-order spare part kits listed ("Accessories" on page 13). Do not use tools or screws not supplied.

#### 3. 3. 1. Platform Installation

**CAUTION** Cutting injuries from sharp edges. When changing a platform, grasp under the platform. Do not lift a platform by clamps mounted on it. Be cautious while handling with platforms and other accessories.

**CAUTION** Use only the screws and the locking tool supplied with the platform. Using other screws or wrong locking tools will lead to improper installation and therefore possibly can damage the shaker and accessories.

Always install a platform with **all** screws.

Always use the proper locking tool:

- 3/16" locking tool (GT530066) for all Solaris 2000 platforms
- 7/32" locking tool (GT530080) for all Solaris 4000 platforms

## Universal Platforms

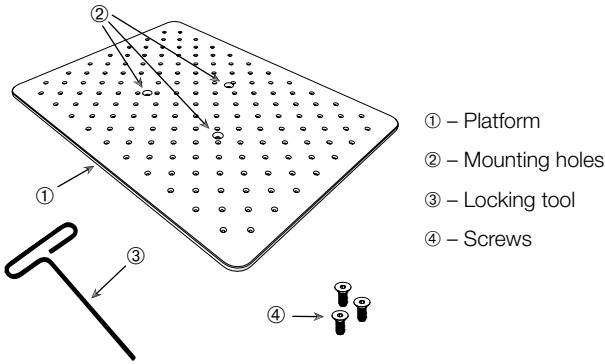

Figure 38: Example of an universal platform

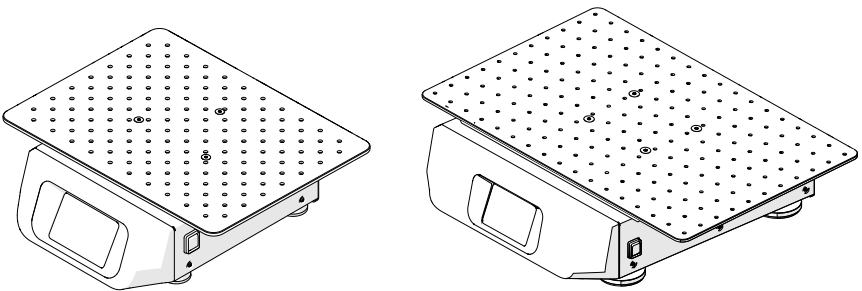

Figure 39: Universal platform installed on a Solaris 2000 (left) and a Solaris 4000 (right) shaker

1. Carefully position the platform horizontally over the shaker and its mounting points.  
Platforms for Solaris 2000 have 3 mounting holes, Platforms for Solaris 4000 have 4 mounting holes.
2. Put a drop of the thread locker to each screw thread before tightening.
3. Tighten the screws gently to secure the platform to the shaker. When the locking tool starts bending, stop tightening.

## Dual Stack Platforms

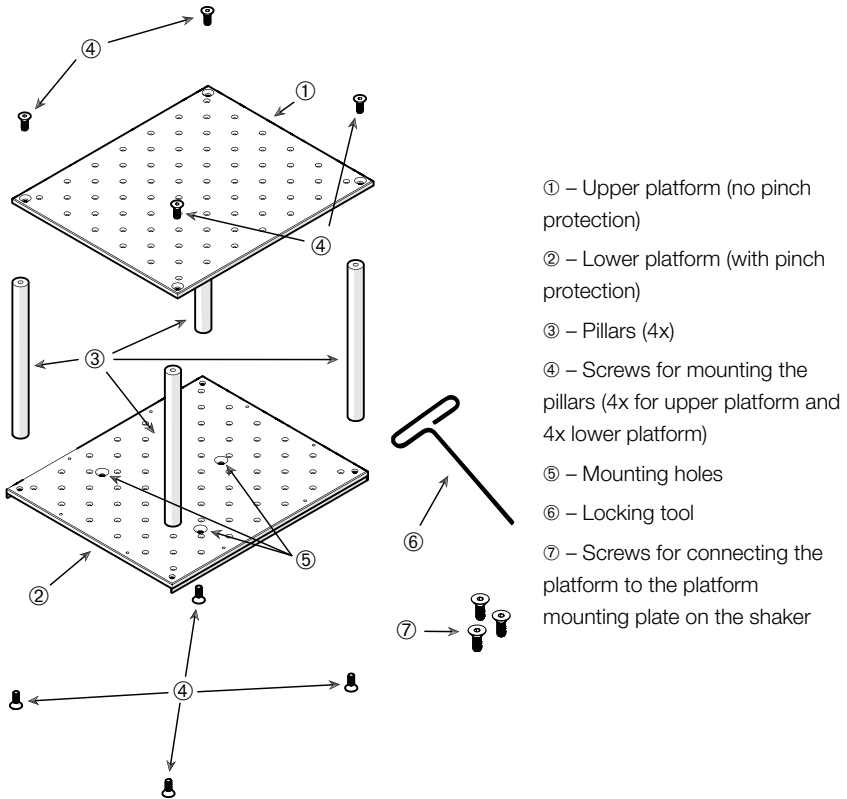

Figure 40: Dual Stack Platform Assembly

Connect the upper and the lower platform by mounting them with the 4 pillars in each corner. Mount the pillars with the proper screws from the upper and from the lower platform. Put a drop of the thread locker to each screw thread before tightening.

Tighten the screws gently to connect the pillar and the platforms. When the locking tool starts bending, stop tightening.

The lower platform is the one with the mounting holes for connecting it to the shaker. Make sure to have the lower platform on the bottom side when assembling.

**NOTICE** Before placing vessels on the platform assembly, make a final check to be sure that the platform assembly does not wobble.

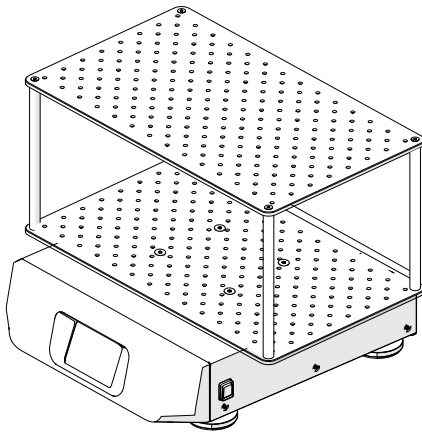

**Figure 41:** Dual stack platform on a Solaris 4000 shaker

1. Carefully position the assembled dual stack platform horizontally over the shaker and its platform mounting plate.  
Platforms for Solaris 2000 have 3 mounting holes, Platforms for Solaris 4000 have 4 mounting holes.
2. Put a drop of thread locker to each screw thread before tightening.
3. Tighten the screws gently to secure the platform to the shaker. When the locking tool starts bending, stop tightening.

### **3. 3. 2. Clamp and Vessel Installation**

**CAUTION** Biological harm due to broken or leaking vessels. Improperly installed accessories can lead to spilled samples. Make sure that accessories are installed properly by using the correct tools and screws. Make sure that accessories fit reasonably on the platform. Always use a vessel with an accessory that fits its size. Vessels must be intact and installed properly.

**CAUTION** Cutting injuries from sharp edges. Be cautious while handling with platforms and other accessories.

## Clamps

Each clamp consists of a vessel clip, one or two springs depending on the clamp/bottle size and screws for mounting it on the platform. Only use the screws supplied with the clamp.

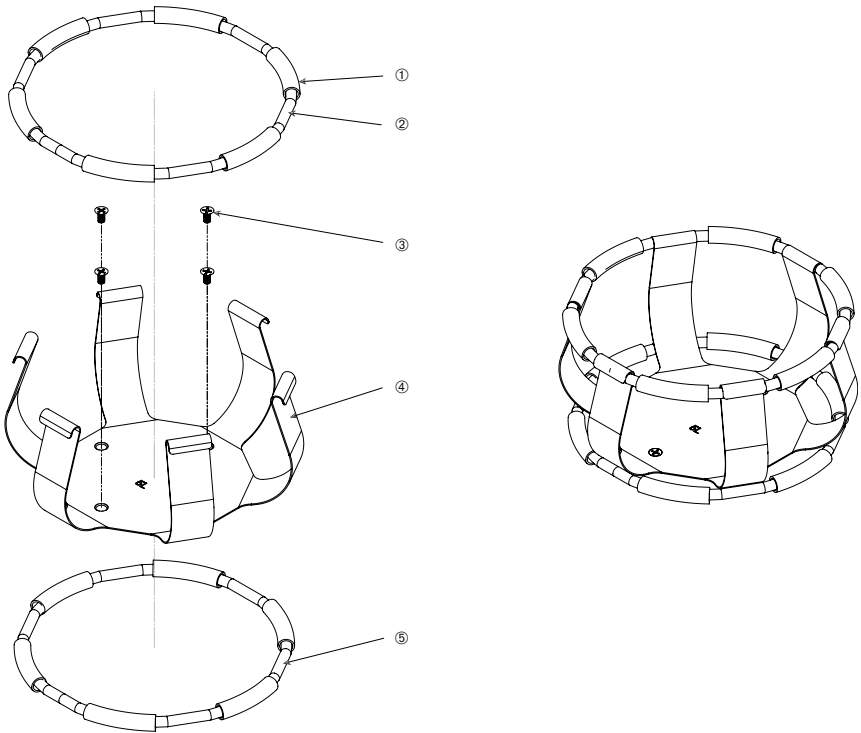

① spring tube ② spring ③ screws ④ clip leg ⑤ spring

**Figure 42:** Clamp details with 2 springs

1. If needed, attach the spring to the clip legs as shown in the illustrations.
2. Some clips use two springs. The rubber spring tubes are positioned between the clip legs as shown in the illustration. The second spring is installed around the base of the clip assembly after it has been mounted to the platform.
3. Attach the clip assembly to the platform with the screws provided.

## Vessel

1. Carefully place the desired vessel in the clamp by first pulling the clamp spring far enough apart to enable the vessel base to be positioned inside the clamp. Gently slide the vessel into its proper position, securing it to the wider bottom of the clamp. The spring will hold the neck of the vessel securely in place.
  - » Each clamp contains a support spring located at the narrow top of the clamp.
  - » Depending on the size of the clamp, the clamp base may contain one or several screws necessary to secure the clamp to the platform. All screws provided with the clamp must be properly attached to the platform.
2. Make sure all vessels are securely clamped before powering on the unit.

Wherever possible, vessels should contain a stopper to prevent hazardous substances from being thrown out during the mixing action.

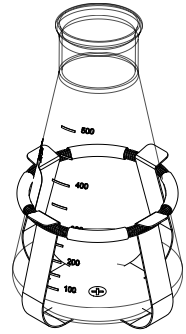

### 3. 3. 3. Test Tube Rack Clamp Installation

**CAUTION** Cutting injuries from sharp edges. Be cautious while handling with platforms and other accessories.

Each test tube rack clamp consists of 2 wire frames with a locking knob and 2 finger screws per wire frame for mounting it on the platform. Each test tube rack clamp comes pre-assembled with a test tube rack and foam insert(s). Always use the screws supplied with the clamp.

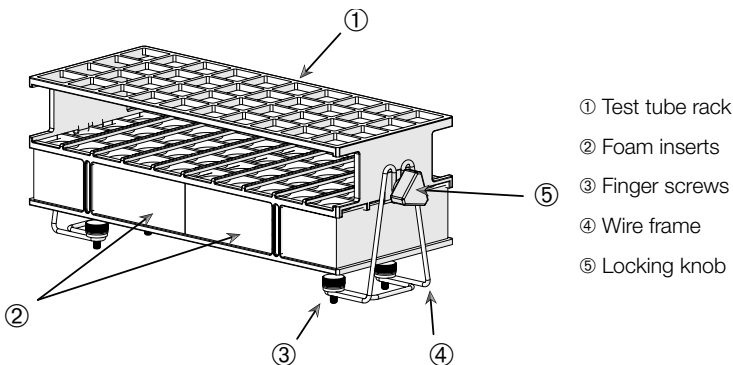

Figure 43: Test Tube Rack Clamp Assembly

1. Install the wire frames on the platform using the finger screws. Tighten the finger screws ③ until hand tight.
2. Set the required angle by using the locking knobs ⑤. Tighten the locking knobs until hand tight.

### 3. 3. 4. Microplate / Deepwell-Plate Installation

**CAUTION** Cutting injuries from sharp edges. Be cautious while handling with platforms and other accessories.

1. Place the microplate frame on the platform.
2. Mount the microplate frame to the platform using the screws supplied with the microplate / deepwell-plate set.
3. Insert the microplate or deepwell-plate into the microplate frame.
4. Make sure that the microplate or deepwell-plate sits tight by lifting it gently. If it sits tight, it is installed properly.

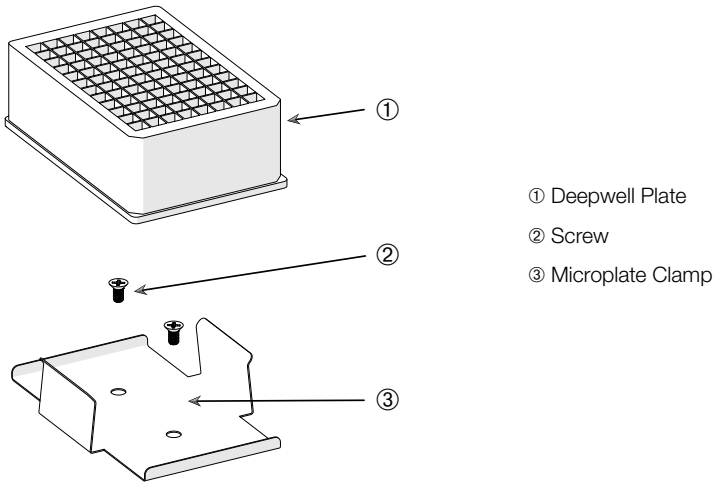

Figure 44: Microplate / Deepwell-plate assembly

### 3. 4. Loading and Normal Use



**Risk of fire due to triggered chemical reactions.**

Do not operate the shaker at speeds that will cause the contents of vessels to be thrown out.

**WARNING**

Increase speed slowly. Try with water before using chemicals.



**Safety can be impaired by improper loading and damaged accessories.**

**CAUTION**

- Make sure that the load (accessories and samples) is arranged symmetrically to the center of the platform. When operating a dual stack platform, make sure that the lower platform carries more load than the upper platform.
- Never overload the shaker. For maximum load refer to „Technical Data“ on page 11. The load contains the weight of the platform, accessories and samples installed on the shaker.
- Make sure that the accessories are installed properly before operating the shaker. Follow the instructions in section „Accessories“ on page 41.

#### Loading

Make sure that the load, including accessories and samples, is arranged symmetrically to the center of the platform. When operating a dual stack platform and not using the complete capacity: in order to achieve best performance load preferably the bottom plate and arrange the load symmetrically to the center of the platform.

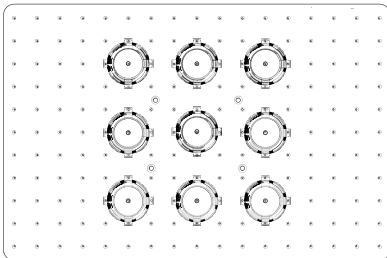

Figure 45: Example for a well loaded platform



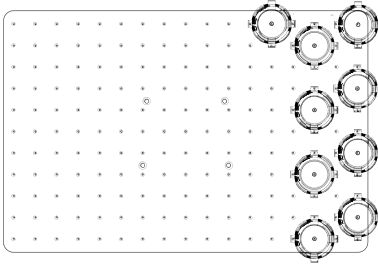

Figure 46: Example for a poorly loaded platform

**NOTICE** The maximum load contains the weight of the platform, accessories and samples installed on the shaker. Refer to “1. 1. Technical Data” on page 11 for details on maximum loading.

## Normal Use

Information on speed-load limitation is given only as a guide to product use. Smooth operation with low or no vibration depends on multiple factors as fill level, type and condition of clamps, type of vessel, arrangement of vessels on platform, the surface the shaker is placed on and on the set speed.

Whenever setting up a new or unknown combination or whenever any of these parameters change: Increase speed above 175 rpm slowly and check for unwanted load vibration or movement of the shaker. It is your responsibility to operate the shaker safely.

Solaris shakers are specially designed for the use inside a range of lab equipment, including environmental chambers, incubators and lab refrigerators providing low heat output and low vibrations. Due to various specific environmental conditions including the stability of shelves and supports the user has the responsibility for safe operation when used inside any lab equipment. Increase speed slowly and check for unwanted instrument movement.

## Safe Speed

The safe speed for any load on Solaris 2000 and Solaris 4000 shaker is 175 rpm. The load contains the weight of the platform, accessories and samples installed on the shaker. Refer to “Technical Data” on page 11 for details on maximum load.

## Highest Speed

At the highest speed of 525 rpm the Solaris 2000 can be operated with a limited load of approximately 3 kg. The load contains the weight of the platform, accessories and samples installed on the shaker. Consider the speed capability of applied clamps and vessels that might not be suitable for that speed.

At the highest speed of 525 rpm the Solaris 4000 can be operated with a limited load of approximately 10 kg. The load contains the weight of the platform, accessories and samples installed on the shaker. Consider the speed capability of applied clamps and vessels that might not be suitable for that speed.

**NOTICE** Always mind that with rising speed clamps will start opening and deliver additional temporary vibration to the system due to greater vessel movement.

### Charts

Following charts will guide you in setting up the best speed-load combination for your normal use. The green area shows speed-load combinations that cause none to minor vibration during shaking operation. The red area shows speed-load combinations that may cause strong vibration during shaking operation and can result in unwanted movement of the shaker. As these charts are for guidance only, you must pay attention when your speed-load combination comes closer to the red area.

Be aware that your specific application conditions may cause unwanted load or instrument behaviour before reaching the shown borderline. Increase the speed gradually to explore the behaviour of your specific load. The load contains the weight of the platform, accessories and samples installed on the shaker.

### Solaris 2000

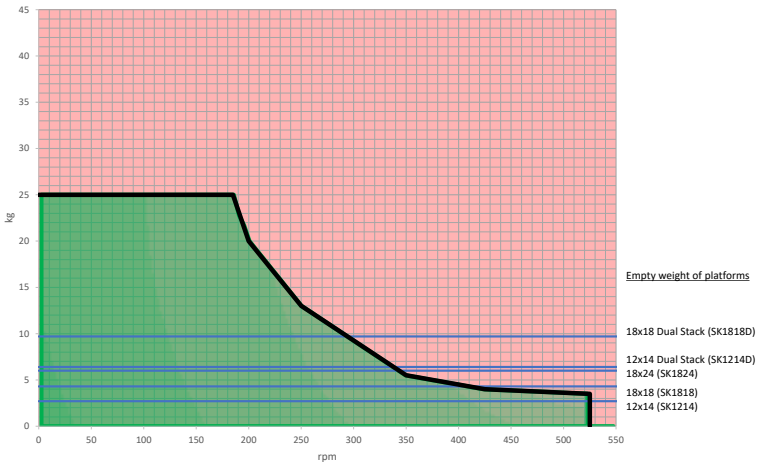

Figure 47: Solaris 2000 – Normal Use

# Solaris 4000



Figure 48: Solaris 4000 – Normal Use

## 4. Maintenance and Care



### WARNING

#### Risk from handling hazardous substances

- If shaking any hazardous materials mind the “Laboratory Biosafety Manual” of the World Health Organization (WHO) and any local regulations. When shaking microbiological samples from the Risk Group II (according to the “Laboratory Biosafety Manual” of the World Health Organization (WHO)), aerosol-tight biological seals have to be used. Look on the internet page of the World Health Organization ([www.who.int](http://www.who.int)) for the “Laboratory Biosafety Manual”. For materials in a higher risk group, extra safety measures must be taken.
- If toxins or pathogenic substances have contaminated the shaker or its parts, appropriate disinfection measures have to be taken (“Decontamination” on page 55; „Disinfection” on page 55).
- If a hazardous situation occurs, turn off the power supply to the shaker and leave the area immediately.



### WARNING

#### Damage to health from infectious substances

If an accidental spill places liquids or other materials under the platform, immediately power off the shaker, unplug it, and remove the platform (“Platforms” on page 13).

Clean up the spill following your regular laboratory procedures. Use proper personal protective equipment.

Any internal adjustments or repairs must be performed by an authorized service technician. The shaker housing is not to be opened by the user.

Follow any product information supplied with the according accessory stating specific details on how to maintain and clean it properly. Use the following information within this chapter only as guideline.

## 4. 1. Basics

For the sake of personal, environmental, and material protection, you must clean and if necessary disinfect the shaker and its accessories on a regular basis.

Thermo Fisher Scientific recommends cleaning and manually disinfecting your laboratory shaker at least once each month. Normal indoor air contains thousands of circulating microorganisms which can take up residence in your shaker, putting your cultures at risk.

Thermo Fisher Scientific recommends using 70% ethanol, or 70% isopropanol or 10% or less quaternary ammonium based disinfectant.

**NOTICE** The mechanism can be damaged by entering liquids. Do not allow liquids, especially organic solvents, to get in contact with the mechanism or the mechanism bearing. Organic solvents break down the grease in the mechanisms bearing.

**NOTICE** Not rated procedures or agents could deteriorate the materials of the shaker and lead to malfunction. Refrain from using any other cleaning or decontamination procedure, if you are not entirely sure that the intended procedure is safe for the equipment. Use only cleaning agents that will not damage the equipment. If in doubt contact the manufacturer of the cleaning agent.

- Pull out the power supply plug before cleaning, disinfecting or decontaminating.
- Remove installed accessories and platform(s) from shaker before cleaning, disinfecting or decontaminating.
- Use warm water with a mild detergent with a soft cloth to clean the materials. If in doubt contact Thermo Fisher Scientific. Rinse off with clean water and dry thoroughly.
- Never use caustic cleaning agents such as phosphoric acid, bleaching solutions or scrubbing powder.
- Use only disinfectants with a pH of 6–8.
- Clean up any spills immediately using a lint-free cloth dampened with a noncorrosive cleaner as instructed by the manufacturer of the cleaning agent.
- Spills can seep under the platform. If any spills get beneath the platform, uninstall the platform and clean up the spill.
- Check the shaker parts and remove any spilled growth media or debris.

### Inspection of Accessories

**NOTICE** Do not run any shaker or accessories with signs of damage. It is recommend that you have accessories inspected on a regular basis as part of your routine service to ensure safety.

After thoroughly cleaning the accessories, they must be inspected for damage, wear and corrosion.

## **Metal Parts**

In case of damage, such as corrosion, wear or cracks, the accessories must be removed from service immediately.

## **Plastic Parts**

Check for signs of crazing, fading, bruising or cracking. In case of damage the inspected item must be removed from service immediately.

## **4. 2. Cleaning**

**NOTICE** Before using any cleaning methods, users should check with the manufacturer of the cleaning agents that the proposed method will not damage the equipment.

**NOTICE** The mechanism can be damaged by entering liquids. Do not allow liquids, especially organic solvents, to get on the mechanism or the mechanism bearing. Organic solvents break down the grease in the mechanisms bearing. Wash the exterior of the unit with a soft cloth using a solution of mild soap and water, rinse off with clean water and dry thoroughly.

Suggested with every 3 months of constant use.

Refer to “Basics” on page 53 for proper cleaning of the shaker and the used accessories.

## **Touchscreen**

To clean the touchscreen:

1. Pull out the power supply plug.
2. Clean the touchscreen using a dry microfiber cloth.
3. If necessary moisten the microfiber cloth with water and wipe the touchscreen again.

### 4. 3. Disinfection

**WARNING** Risk from handling hazardous substances. Do not touch infected parts. Hazardous infection is possible when touching the contaminated parts. Infectious material can get into the shaker when a vessel breaks or as a result of spills. In case of contamination, make sure that no one is put at risk. Disinfect the affected parts immediately.

**NOTICE** Equipment can be damaged by inappropriate disinfection methods or agents. Make sure that the disinfection agent or the method will not damage the equipment. In doubt contact the manufacturer of the disinfection agent. Observe the safety precautions and handling instructions for the disinfection agents used.

1. Wipe all parts and areas with 70% ethanol as required by the level of disinfection you need. Do not wet any areas with exposed electronics.
2. Allow to air dry.

You are responsible that the level of disinfection is achieved according to your requirements.

### 4. 4. Decontamination

**WARNING** Risk from handling hazardous substances. Do not touch contaminated parts. Exposure to contamination is possible when touching the contaminated parts. Contaminated material can get into the shaker when a tube breaks or as a result of spills. In case of contamination, make sure that no one is put at risk. Decontaminate the affected parts immediately.

**NOTICE** Equipment can be damaged by inappropriate decontamination methods or agents. Make sure that the decontamination agent or the method will not damage the equipment. If in doubt contact the manufacturer of the decontamination agent. Observe the safety precautions and handling instructions for the decontamination agents used.

The following method is suggested by Thermo Fisher Scientific.

1. Wipe all parts and areas with 70% ethanol. Do not wet any areas with exposed electronics.
2. Allow to air dry.

You are responsible that the level of decontamination is achieved according to your requirements.

## 4. 5. Autoclaving

**NOTICE** Never exceed the permitted temperature and duration when autoclaving. No chemical additives are permitted in the steam.

Before autoclaving:

- Disassemble all accessories.
- Thoroughly rinse off any trace of chemicals or detergents. Include a final rinse with distilled water.

Follow this table to check autoclavability:

Item	Autoclavable	Specifications
Shaker	No	-
Platform	Yes	135 °C, 20 min
Clamp (without spring tubes)	Yes	135 °C, 20 min
Test Tube Rack Clamp – Metal Parts	Yes	135 °C, 20 min
Test Tube Rack Clamp – Plastic Parts (Nalgene™ ResMer™)	Yes	121 °C, 20 min
Test Tube Rack Clamp – Plastic Parts (Nalgene Unwire™)	No	-
Test Tube Rack Clamp – Foam Inserts	No	-
Microplate Clamp	Yes	135 °C, 20 min
Adhesive Mat	No	-

**Table 10:** Autoclavability of materials

Make sure that the necessary sterility is achieved according to your requirements. Appearance and color may change slightly after autoclaving.



## 4. 6. Service

Thermo Fisher Scientific recommends having the shaker and accessories serviced once per year by an authorized service technician. The service technician checks the following:

- electrical equipment
- suitability of set-up site
- safety system
- used accessories
- fixation of clamps and platforms and other accessories on the shaker

Before service, shaker and accessories should be thoroughly cleaned and decontaminated to ensure that full and safe inspection can be completed.

Thermo Fisher Scientific offers inspection and service contracts for this work. Any necessary repairs are performed for free during the warranty period and afterwards for a charge. That is only valid if the shaker has been maintained by an authorized Thermo Fisher Scientific service technician.

## 4. 7. Shipping and Disposal

**WARNING** Damage to health from infectious substances. When removing the shaker and accessories from use for disposal you have to clean and if necessary disinfect or decontaminate them. If in doubt contact the Thermo Fisher Scientific customer service.

For the disposal of the shaker mind the regulations in your country. Contact the Thermo Fisher Scientific Customer Service for the disposal of the shaker. For contact information check the back page of this manual or visit [www.thermofisher.com](http://www.thermofisher.com).

Mind the information on transport and shipping (“Transporting” on page 23, “Shipping” on page 27).

## 5. Troubleshooting

**NOTICE** If an error message shows that is not listed in this table, a service technician must be contacted.

No.	Description	Solutions
<b>Errors</b>		
1-150	An internal error occurred	An internal error occurred. Please power off and on the unit. If the error message still shows, contact a service technician.
<b>Alerts</b>		
4	Power Resumed and Autostart Enabled	A power outage occurred during the last run. After the power has been restored the run has been resumed automatically.
5	Watchdog Timeout occurred	The system has been reset due to an internal error. Please check your samples and/or settings.
<b>Alarms</b>		
3	Autostart after power outage failed	A power outage occurred during the last run. Auto restart could not be executed successfully.
4	Shaker walking away (Motion detection)	Shaker motion detected. Please check that the shaker is installed correctly and/or your settings and/or load (accessories and samples) on the platform.
5	Drive acceleration too slow. Desired set speed cannot be reached.	The desired set speed could not be reached within time. Please check your settings and/or load (accessories and samples) on the platform.
12	Drive start up error - no speed signal received.	Shaker platform is blocked. Please check if enough space is available around platform and/or reduce load (accessories and samples) on platform. Afterwards press START again on the shaker. If the error message still shows, contact a service technician.

No.	Description	Solutions
24	Speed measurement error during a run.	Abnormal speed change detected. Please check load (accessories and samples) and/or clamps on the shaker platform. Afterwards press START again on the shaker. If the error message still shows, contact a service technician.
	Speed comparison failed.	Shaker platform has been blocked during run. Please check if enough space is available around platform and/or reduce load (accessories and samples) on the platform. Afterwards press START again on the shaker. If the error message still shows, contact a service technician.
26	Speed measurement detected unexpected standstill during run.	Make sure that enough space is available around the platform and/or reduce load (accessories and samples) on the platform. Make sure that the fuse on the back of the shaker has not tripped ("Fuse" on page 20). Afterwards press START again on the shaker. If the error message still shows, contact a service technician.
82	Motor current measurement detects overload.	Motor overcurrent detected. Do not load or unload platform while running. Reduce speed or adjust load (accessories and samples) on platform.
83	Motor current measurement out of boundaries.	Motor overcurrent detected. Do not load or unload platform while running. Reduce speed or adjust load (accessories and samples) on platform.

**Table 11:** Troubleshooting

# Index

## A

---

Accessories 13, 41  
Alarms 30  
Alerts 30  
Autoclaving 56  
Auto Restart 32

## B

---

Brightness 32

## C

---

Care 52  
Charts 40  
Clamps 14  
Cleaning 54  
Connections 20  
Controls 30

## D

---

Date 32  
Decontamination 55  
Directives 18  
Disinfection 55  
Display 32  
Disposal 57  
Dual Stack 43

## E

---

Ethernet 20  
Event Log 38

## F

---

Files and Info 33  
Fuse 20

## H

---

Highest Speed 49

## I

---

Inspection of Accessories 53  
Intended Use 6  
Items Supplied 21

## L

---

Language 32  
Leveling 23  
Loading 48  
Location 22

## M

---

Mains Connection 20  
Maintenance 52  
Menu Bar Customization 32  
Metal Parts 54  
Microplate / Deepwell-Plate 47

## N

---

Normal Use 48, 49

## O

---

Operation 28  
Orbit Calculator 31

## P

---

Plastic Parts 54  
Platform Installation 41  
Platforms 13  
Product Overview 19  
Programs 33

## R

---

Region 32

## **S**

---

Safe Speed 49  
Service 57  
Settings 30  
Shipping 27, 57  
Signal Words and Symbols 6  
Sleep Mode 33  
Snooze Timeout 30  
Speed Setpoint 30  
Standards 18  
Startup 24  
Storage 27  
Symbols used in the Instruction Manual 7

## **T**

---

Technical Data 11  
Technical Specifications 11  
Test Tube Rack Clamp 46  
Test Tube Racks 16  
Time 32  
Time Mode 32  
Transporting 23  
Troubleshooting 58

## **U**

---

Unit Name 32  
Universal Platforms 42  
Unpacking 21  
USB 20  
User Interface 28

## **V**

---

Volume 30

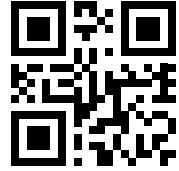

### Manufactured for

Thermo Electron LED GmbH  
Zweigniederlassung Osterode  
Am Kalkberg, 37520 Osterode am Harz  
Germany

### Made in USA



Thermo Scientific Solaris 2000

Thermo Scientific Solaris 4000

70900190 is the original instruction manual.  
This instruction manual is a translation of the original instruction manual.

[thermofisher.com/shaker](http://thermofisher.com/shaker)

© 2019 Thermo Fisher Scientific Inc. All rights reserved.

All trademarks are the property of Thermo Fisher Scientific Inc. and its subsidiaries unless otherwise indicated. Not all products are available in all countries. Please consult your local sales representative for details.

Shown pictures within the manual are examples and may differ considering the set parameters and language.

### Australia

+61 39757 4300

### Austria

+43 1 801 40 0

### Belgium

+32 53 73 42 41

### China

+800 810 5118  
or +400 650 5118

### France

+33 2 2803 2180

### Germany national toll free

0800 1 536 376

### Germany international

+49 6184 90 6000

### India

+91 22 6716 2200

### Italy

+39 02 95059 552

### Japan

+81 3 5826 1616

### Netherlands

+31 76 579 55 55

### New Zealand

+64 9 980 6700

### Nordic/Baltic/CIS countries

+358 10 329 2200

### Russia

+7 812 703 42 15

### Spain/Portugal

+34 93 223 09 18

### Switzerland

+41 44 454 12 12

### UK/Ireland

+44 870 609 9203

### USA/Canada

+1 866 984 3766

### Other Asian Countries

+852 2885 4613

### Countries not listed

+49 6184 90 6000